



## User Instruction Manual

### DuraTech<sup>®</sup> Cable SRL



This manual is intended to meet the Manufacturer's Instructions as required by the American National Standards Institute (ANSI) Z359 and should be used as part of an employee training program as required by the Occupational Safety and Health Administration (OSHA).

#### FallTech

1306 South Alameda Street Compton, CA 90221, USA

1-800-719-4619 • 1-323-752-0066

[www.FallTech.com](http://www.FallTech.com)

©2023

## **Table of Contents**

1.0 Warnings and Important Information .....	3
2.0 Description .....	3
3.0 Application .....	5
4.0 System Requirements.....	5
5.0 Installation and Use .....	7
6.0 Maintenance, Service, and Storage.....	11
7.0 Inspection.....	12
8.0 Labels.....	15
9.0 Definitions.....	16

For the purposes of this manual, the FallTech Duratech Cable Self-Retracting Lifeline (SRL), in all iterations may be referred to collectively as the DuraTech, the DuraTech SRL, the cable SRL, the SRL, the SRD, the self-retracting lifeline, the self-retracting device, the equipment, the device, the product, or the unit.

## 1.0 Warnings and Important Information

### **WARNING**

- Avoid moving machinery, thermal, electrical and/or chemical hazards as contact may cause serious injury or death.
- Avoid swing falls.
- Follow the weight restrictions and recommendations in this manual.
- Remove from service any equipment subjected to fall arrest forces.
- Remove from service any equipment that fails inspection.
- Do not alter or intentionally misuse this equipment.
- Consult FallTech when using this equipment in combination with components or subsystems other than those described in this manual.
- Do not connect rebar hooks, large carabiners, or large snap hooks to the FBH dorsal D-rings as this may cause a roll-out condition and/or unintentional disengagement.
- Avoid sharp and/or abrasive surfaces and edges.
- Use caution when performing arc welding. Arc flash from arc welding operations, including accidental arcs from electrical equipment, can damage equipment and are potentially fatal.
- Examine the work area. Be aware of the surroundings and workplace hazards that may impact safety, security, and the functioning of fall arrest systems and components.
- Hazards may include but not be limited to cable or debris tripping hazards, equipment failures, personnel mistakes, moving equipment such as carts, barrows, fork lifts, cranes, or dollies. Do not allow materials, tools or equipment in transit to contact any part of the fall arrest system.
- Do not work under suspended loads.

### **IMPORTANT**

This product is part of a personal fall arrest, restraint, work positioning, suspension, or rescue system. A Personal Fall Arrest System (PFAS) is typically composed of an anchorage and a Full Body Harness (FBH), with a connecting device, i.e., a Shock Absorbing Lanyard (SAL), or a Self-Retracting Device (SRD), attached to the dorsal D-ring of the FBH.

These instructions must be provided to the worker using this equipment. The worker must read and understand the manufacturer's instructions for each component or part of the complete system. Manufacturer's instructions must be followed for proper use, care, and maintenance of this product. These instructions must be retained and be kept available for the worker's reference at all times. Alterations or misuse of this product, or failure to follow instructions, may result in serious injury or death.

A Fall Protection Plan must be on file and available for review by all workers. It is the responsibility of the worker and the purchaser of this equipment to assure that users of this equipment are properly trained in its use, maintenance, and storage. Training must be repeated at regular intervals. Training must not subject the trainee to fall hazards.

Consult a doctor if there is reason to doubt your fitness to safely absorb the shock of a fall event. Age and fitness seriously affect a worker's ability to withstand falls. Pregnant women or minors must not use this equipment.

ANSI limits the weight of fall protection equipment users to a maximum of 310 lbs. Products in this manual may have a rated capacity exceeding ANSI capacity limits. Heavy users experience more risk of serious injury or death due to falls because of increased fall arrest forces placed on the user's body. In addition, the onset of suspension trauma after a fall even may be accelerated for heavy users.

The user of the equipment discussed in this manual must read and understand the entire manual before beginning work.

**NOTE:** For more information consult the ANSI Z359 body of standards.

## 2.0 Description

The FallTech® DuraTech Cable SRL is a self-retracting device for those working at height and subject to fall hazards. This manual contains one Appendix that contains figures and tables specific to the

DuraTech Cable SRL discussed in this manual. This product is not suitable for applications with leading edge exposures where the lifeline of this device may come in contact with an edge during a fall event.

A handle/attachment point is cast into the housing. The housing contains various lengths of lifeline composed of galvanized steel wire rope wound onto a spring-tensioned drum. The SRD lifeline is equipped with a spring bumper to reduce retraction freewheel shock loads.

**NOTE:** Freewheel refers to the uncontrolled retraction of the cable into the housing. Always maintain tension on the cable, with a tag line if necessary, and do not allow the SRD to retract the cable in an uncontrolled manner, as this could damage the unit.

As shown in Figure 1 below, the SRD has an aluminum housing with an integrated handle that contains a lifeline composed of 7/32" diameter wire rope, wound onto a spring tensioned drum. The SRD's lifeline is equipped with a cable stop/handle assembly with a spring bumper, and a load-indicating swiveling snap hook. When the user is attached, the lifeline extends and retracts with user movement, automatically maintaining a taut lifeline. If a fall occurs, a centrifugal pawl system engages, a centrifugal pawl system locks and applies a brake, slowing and arresting the fall.

See Table 1A in Appendix A for product and materials specifications.

Figure 1 - About FallTech® DuraTech Cable SRL	
1	Anchorage Connecting Handle
2	SRD Unit Housing
3	Product/Warning Labels
4	Cable Stop/Handle Assembly
5	Load-Indicting Snap Hook

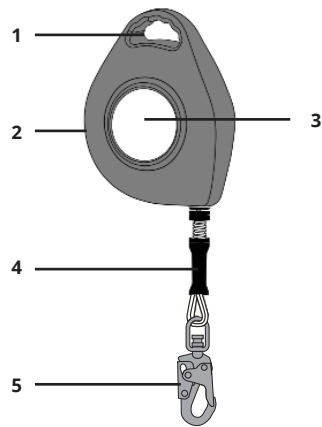

## 2.1 American National Standards Institute (ANSI) and Occupational Safety and Health Administration (OSHA):

The SRD discussed in this manual meets the standards of ANSI Z359.14-2021, ANSI A10.32-2012, and Occupational Safety and Health Administration (OSHA) regulations 1926.502 and 1910.140. ANSI requires SRDs be classified according to the type of usage the user would be exposed to, and are tested either as Class 1 or Class 2. Dynamic performance means that the SRD is installed in a testing drop tower. A test weight is attached to the SRD and then dropped. Test results are recorded.

Parameters tested are:

- Arrest Distance (AD)
- Average Arrest Force (AAF)
- Maximum Arrest Force (MAF)

The Arrest Distance is the total vertical distance required to arrest a fall. The Arrest Distance includes the deceleration distance and the activation distance. The Average Arrest Force is the average of the forces applied to the body and the anchorage by the fall protection system. The Maximum Arrest Force is the maximum amount of force that may be applied to the body and the anchorage by the fall protection system. In addition to the above tests conducted in ambient conditions, the units must be retested for average and peak forces under certain environmental conditions, where the units are cooled, then tested, heated, then tested, or saturated in water and tested again. Separate units may be used for each test. All test results are recorded. This test data is then used to establish the basis for fall clearance guidelines published in the user instruction manual. Class 1 and 2: Class 1 devices shall be used only on overhead anchorages and shall be subjected to a maximum free fall of 2 feet (0.6 m) or less. Class 2 devices are intended for applications where an overhead anchorage may not be available or feasible and be subjected to a free fall of no more than 6 feet (1.8 m) over an edge. To be

declared a Class 1 and Class 2 device, ANSI requires an SRD to have an overhead Arrest Distance of less than 42" (1.1 m), an Average Arrest Force of less than 1,350 lbs (6 kN) [1,575 lbs (7 kN) conditioned] and a Maximum Arresting Force of 1,800 lbs (8 kN), for both ambient and conditioned testing. When dynamically tested in accordance with requirements of ANSI Z359.14-2021, FallTech Class 1 and Class 2 Self-Retracting Devices have an AAF of 1,350 lbs (6 kN) or less and an AD of less than 42" (1.1 m). Please see Section 5 of this user instruction manual for how to calculate your Minimum Required Fall Clearance (MRFC).

### **3.0 Application**

#### **3.1 Purpose:**

The FallTech DuraTech Cable SRL is designed to be used as a component in a Personal Fall Arrest System (PFAS), to provide a combination of worker mobility and fall protection as required for inspection work, general construction, maintenance work, oil production, confined space work, etc. The SRD is intended for Personal Fall Arrest applications only.

#### **3.2 Personal Fall Arrest System:**

A PFAS is an assembly of components and subsystems used to arrest a person during a fall event. A PFAS typically consists of an anchorage, a deceleration device such as a Shock Absorbing Lanyard (SAL), a Self-Retracting Device (SRD), or a Fall Arrestor Connecting Subsystem (FACSS), and a properly fitted Full Body Harness (FBH). Maximum permissible free fall in a typical PFAS is 6'. The Self-Retracting Devices discussed in this manual are intended for overhead use. Other applications may be below the D-ring, or horizontally in an approved FallTech SRD rotating anchor, designed for such use.

#### **3.3 Horizontal Lifeline (HLL) and Rail Systems:**

The SRD may be attached to rigid and flexible anchors provided that all HLL or rail system applications, installation, and uses are under the supervision of a Qualified Person.

#### **3.4 Rescue:**

Ensure a written rescue plan, method and system is in place and readily available for rapid response. Rescues may require specialized equipment or measures. Rescue operations are beyond the scope of this manual. See ANSI Z359.4 and Z359.2.

#### **3.5 Application Limits:**

Take action to avoid moving machinery, sharp edges, abrasive surfaces, and thermal, electrical, including the arc from welding applications, and chemical hazards as contact may cause serious injury or death. The SRD is not designed for use in restraint, personnel riding, suspension, or work positioning. Rescue applications are beyond the scope of this manual. Do not use the SRD for these applications except as a back-up PFAS. The SRD discussed in this manual is not designed for Leading Edge applications.

### **4.0 System Requirements**

#### **4.1 Capacity:**

The SRD is designed for use by a single user with a combined weight of user, tools, clothing, etc., of 130 – 310 lbs. (59-141 kg).

#### **4.2 Compatibility Of Connectors:**

Connectors are considered to be compatible with connecting elements when they have been designed to work together in such a way that their sizes and shapes do not cause their gate mechanisms to inadvertently open regardless of how they become oriented. Contact FallTech if you have any questions about compatibility. Connectors must be compatible with the anchorage or other system components. Do not use equipment that is not compatible. Non-compatible connectors may unintentionally disengage. Connectors must be compatible in size, shape, and strength. Self-closing, self-locking connectors are required by ANSI and OSHA.

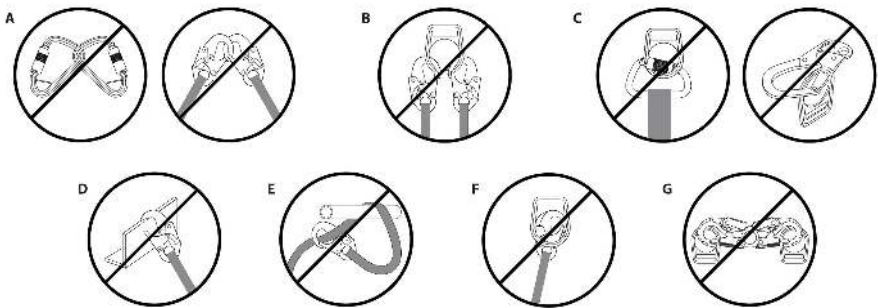

**Figure 2: Incorrect Connections**

<b>A</b>	Never connect two active components (snap hooks or carabiners) to each other.
<b>B</b>	Never connect two active components (snap hooks or carabiners) to a single D-ring at the same time.
<b>C</b>	Never connect in a way that would produce a condition of loading on the gate.
<b>D</b>	Never attach to a object in a manner whereby the gate (of the snap hook or carabiner) would be prevented from fully closing and locking. Always guard against false connections by visually inspecting for closure and lock.
<b>E</b>	Never attach explicitly to a constituent subcomponent (webbing, cable or rope) unless specifically provided for by the manufacturer's instructions for both subcomponents (snap hook or carabiner and webbing, cable or rope).
<b>F</b>	Never attach in a manner where an element of the connector (gate or release lever) may become caught on the anchor thereby producing additional risk of false engagement.
<b>G</b>	Never attach a spreader snap hook to two side/positioning D-rings in a manner whereby the D-rings will engage the gates; the gates on a spreader must always be facing away from the D-rings during work positioning.

### 4.3 Compatibility Of Components:

Equipment is designed for use with approved components and subsystems only. Substitutions or replacements made with non-approved components or subsystems may jeopardize compatibility of equipment and may affect the safety and reliability of the complete system.

### 4.4 Making Connections:

Only use self-locking connectors with this equipment. Only use connectors that are suitable to each application. Ensure all connections are compatible in size, shape, and strength. Do not use equipment that is not compatible. Visually ensure all connectors are fully closed and locked. Connectors are designed to be used only as specified in each product's user's instructions.

### 4.5 Personal Fall Arrest System:

A PFAS is an assembly of components and subsystems used to arrest a person during a fall event. A PFAS is typically composed of an anchorage and a FBH, with an energy absorbing connecting device, i.e., an SAL, an SRD, or a Fall Arrestor Connecting Subsystem (FACSS), connected to the dorsal D-ring of the FBH. PFAS components used in conjunction with this SRD should comply with ANSI Z359 requirements and applicable OSHA regulations.

#### 4.5.1 Personal Fall Arrest System Anchorage Strength:

An anchorage selected for PFAS application must have the strength to sustain a static load applied in the direction permitted by the PFAS of at least:

- Two times the maximum arrest force permitted when certification exists, or
- 5,000 lbs. (22.2 kN) in the absence of certification.

Table 1B provides test data on typical performance attributes of the three principal parameters (see

Section 2.1) for FallTech self-retracting devices, listed by model number and class. In certain situations, the Qualified Person can determine that a given structure is a suitable anchor point based on a tested arrest distance and tested maximum arrest force, with a safety factor of two.

The Competent Person may find this data useful with planning anchorage location and calculating fall arrest loads and distances from the walking/working level to the nearest obstruction or lower level. See Section 5.

## 5.0 Installation and Use

### WARNING

**Do not alter or intentionally misuse this equipment. Consult FallTech when using this equipment in combination with components or subsystems other than those described in this manual. All components or subsystems used with the SRD discussed in this manual must be in compliance with ANSI Z359 and OSHA.**

**Do not use rebar hooks, large carabiners or large snap hooks to connect to the FBH dorsal D-rings or to any small diameter non-compatible anchor point as this may cause a roll-out condition and/or unintentional disengagement.**

**Do not insert extra connectors between the SRD lifeline connector and the FBH dorsal D-ring, except an approved D-ring extender.**

**Use caution. Take action to avoid sharp and/or abrasive surfaces and edges when possible.**

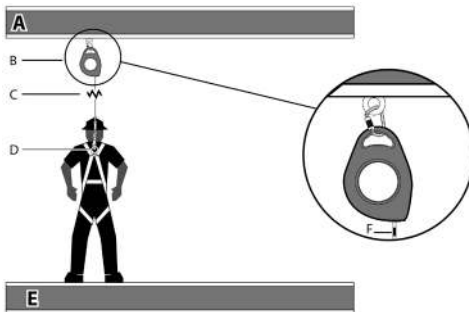

**Figure 3 - Overhead Anchorage**

Figure 3 - Overhead Anchorage	
<b>A</b>	Overhead Anchorage
<b>B</b>	Self-Retracting Lifeline
<b>C</b>	Line Constituent
<b>D</b>	SRL Connection to FBH
<b>E</b>	Walking/Working Surface
<b>F</b>	Green Indicator - Regular Safe Operating Condition of Cable Lifeline Length

### 5.1. Install the SRD:

Examine the work area for possible hazards. Take caution to avoid overhead hazards such as cranes, poles, overhead power cables, and walking/working surface hazards such as power cables, welding leads, air and fluid hoses, including obstruction hazards such as vertical columns and stacks of materials on the lower level. Eliminate hazards where possible.

Ensure the anchorage provides the Minimum Required Fall Clearance (MRFC) in the fall path below the walking/working surface to prevent striking the lower level or an obstruction during a fall event. Take action to avoid swing falls, which occur when the anchorage is not directly above the point where the fall occurs.

Fall clearance and swing falls are subject to variable conditions. Anchor height, lateral movement, and setback distance all affect anchor location with regard to fall clearance and swing fall.

The SRD may be attached to an overhead anchor, see Figure 3, i.e. above the user's FBH dorsal D-ring. The SRD discussed in this manual is not designed for Leading Edge applications.

## 5.2 Calculating SRL Minimum Required Fall Clearance (MRFC)

### 5.2.1 DuraTech in Overhead, Non-Leading Edge Anchorage Application

The DuraTech may be used as a standard SRD in an overhead condition, in which the SRD is installed anywhere in the allowable attachment area, which ranges from directly above the user to level with the FBH D-ring, as shown in Figure 4.

The overhead condition minimum required fall clearance (MRFC) is calculated using four metrics, measured from the walking-working surface: SRD Deceleration Distance, D-Ring Shift and Harness Stretch [1 ft (0.3m)], Safety Factor [1.5 ft (0.5m)], and Swing Fall. Chart 1 below is calculated using the performance data of the SRD and includes all four metrics listed previously to determine the MRFC.

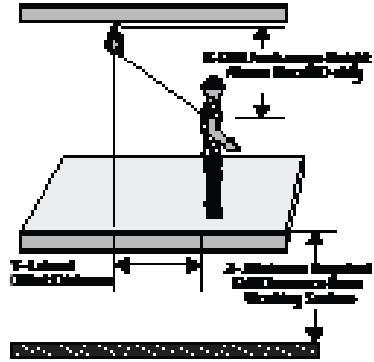



Figure 4

Figure 4 - MRFC Overhead Anchorage

Chart 1 Overhead		Lateral Offset Distance (Y)												
		0 ft (0 m)	2 ft (0.7 m)	4 ft (1.3 m)	6 ft (1.9 m)	8 ft (2.5 m)	10 ft (3.1 m)	12 ft (3.7 m)	14 ft (4.3 m)	16 ft (4.9 m)	18 ft (5.5 m)	20 ft (6.1 m)	22 ft (6.8 m)	24 ft (7.4 m)
SRD Anchorage Height Above D-Ring (X)	60 ft (18.3 m)	5.0 (1.5)	5.5 (1.7)	5.5 (1.7)	5.5 (1.7)	6.0 (1.9)	6.0 (1.9)	6.5 (1.9)	7.0 (2.1)	7.5 (2.2)	8.0 (2.4)	8.5 (2.5)	9.0 (2.7)	10.0 (3.0)
	55 ft (16.8 m)	6.0 (1.9)	5.5 (1.7)	5.5 (1.7)	5.5 (1.7)	6.0 (1.9)	6.0 (1.9)	6.5 (1.9)	7.0 (2.1)	7.5 (2.2)	8.0 (2.4)	9.0 (2.7)	9.5 (2.9)	10.5 (3.2)
	50 ft (15.3 m)	6.5 (1.9)	5.5 (1.7)	5.5 (1.7)	5.5 (1.7)	6.0 (1.9)	6.0 (1.9)	6.5 (1.9)	7.0 (2.1)	7.5 (2.2)	8.5 (2.5)	9.0 (2.7)	10.0 (3.0)	10.5 (3.2)
	45 ft (13.8 m)	7.0 (2.1)	5.5 (1.7)	5.5 (1.7)	5.5 (1.7)	6.0 (1.9)	6.5 (1.9)	7.0 (2.1)	7.5 (2.2)	8.0 (2.4)	8.5 (2.5)	9.5 (2.9)	10.5 (3.2)	11.0 (3.3)
	40 ft (12.2 m)	7.5 (2.2)	5.5 (1.7)	5.5 (1.7)	5.5 (1.7)	6.0 (1.9)	6.5 (1.9)	7.0 (2.1)	7.5 (2.2)	8.5 (2.5)	9.0 (2.7)	10.0 (3.0)	11.0 (3.3)	12.0 (3.6)
	35 ft (10.7 m)	8.0 (2.4)	5.5 (1.7)	5.5 (1.7)	6.0 (1.9)	6.0 (1.9)	6.5 (1.9)	7.0 (2.1)	8.0 (2.4)	8.5 (2.5)	9.5 (2.9)	10.5 (3.2)	11.5 (3.5)	12.5 (3.7)
	30 ft (9.2 m)	8.5 (2.5)	5.5 (1.7)	5.5 (1.7)	6.0 (1.9)	6.5 (1.9)	7.0 (2.1)	7.5 (2.2)	8.5 (2.5)	9.0 (2.7)	10.0 (3.0)	11.5 (3.4)	12.5 (3.8)	13.5 (4.0)
	25 ft (7.7 m)	9.0 (2.7)	5.5 (1.7)	5.5 (1.7)	6.0 (1.9)	6.5 (1.9)	7.0 (2.1)	8.0 (2.4)	9.0 (2.7)	10.0 (3.0)	11.0 (3.3)	12.5 (3.8)	13.5 (4.0)	15.0 (4.6)
	20 ft (6.1 m)	9.5 (2.9)	5.5 (1.7)	5.5 (1.7)	6.0 (1.9)	7.0 (2.1)	7.5 (2.2)	8.5 (2.5)	9.5 (2.9)	11.0 (3.3)	12.0 (3.6)	13.5 (4.0)	15.0 (4.6)	16.5 (5.0)
	15 ft (4.6 m)	10.0 (3.1)	5.5 (1.7)	6.0 (1.9)	6.5 (1.9)	7.0 (2.1)	8.5 (2.5)	9.5 (2.9)	11.0 (3.3)	12.0 (3.6)	13.5 (4.0)	15.0 (4.6)	17.0 (5.1)	18.5 (5.6)
	10 ft (3.1 m)	6.0 (1.9)	5.5 (1.7)	6.0 (1.9)	7.0 (2.1)	8.0 (2.4)	9.5 (2.9)	11.0 (3.3)	12.5 (3.7)	14.0 (4.3)	16.0 (4.9)	17.5 (5.3)	19.5 (5.9)	21.0 (6.4)
	5 ft (1.6 m)	6.0 (1.9)	5.5 (1.7)	6.5 (1.9)	8.0 (2.4)	9.5 (2.9)	11.5 (3.5)	13.0 (3.9)	15.0 (4.6)	17.0 (5.1)	19.0 (5.8)	21.0 (6.4)	23.0 (7.0)	25.0 (7.6)
	0 ft (0 m)	5.0 (1.5)	7.0 (2.1)	9.0 (2.7)	11.0 (3.3)	13.0 (3.9)	15.0 (4.6)	17.0 (5.1)	19.0 (5.8)	21.0 (6.4)	23.0 (7.0)	25.0 (7.6)	27.0 (8.2)	29.0 (8.8)

Using Chart 1 to Calculate Minimum Required Fall Clearance for the DuraTech	
2 foot (0.6 m) increments along the Y-Axis represent the Lateral Offset Distance the user is working away from being directly under the SRD	5 foot (1.5 m) increments up the X-Axis represent the SRD Anchorage Height above the user's Dorsal D-Ring
<b>Example:</b> If the user needs to work 10 feet (3.1 m) away from directly under the SRD, the SRD needs to be anchored at least 15 feet (4.6 m) above the user's Dorsal D-Ring. Minimum required fall clearance is 8.5 feet (2.5 m) at maximum allowable swing fall.	
<b>Example:</b> If the only suitable Anchorage for the SRD is at D-Ring height [0.0 feet (0.0 m)] above the user's Dorsal D-Ring, the maximum allowable work zone is 4 feet (1.3 m) away from the SRD. Minimum required fall clearance is 9.0 feet (2.7 m) at maximum allowable swing fall.	
<b>Key to Work Zone Areas:</b> <div style="display: flex; justify-content: space-around; align-items: center;"> <div style="text-align: center;"> <input type="checkbox"/> = Allowable Use Area         </div> <div style="text-align: center;"> <input style="background-color: red;" type="checkbox"/> = Not Allowed Use Area         </div> </div>	
<div style="display: flex; justify-content: space-around; align-items: center;"> <div style="text-align: center;">  <p><b>WORKING IN THIS AREA</b></p> </div> <div style="text-align: center;">  <p><b>MAY RESULT IN SERIOUS INJURY OR DEATH</b></p> </div> </div>	

### 5.3 Operation of the SRD:

Before each use, inspect the SRD, see Section 7 for inspection instructions.

#### 5.3.1 Locking Mechanism:

The SRL utilizes an acceleration based locking mechanism. The locking function requires a certain payout rate during a fall event to function correctly. Certain situations, confined or cramped spaces, shifting footing such as sand, gravel, grain, or a sloped surface may not allow the lifeline to reach sufficient speed to activate the lock mechanism. A clear path is required to assure positive locking of the SRD. Ensure the lock is functioning properly. Pull the lifeline out a short distance and give it a sharp tug. The lifeline must lock. If it fails to lock, remove it from service immediately. Ensure the work zone remains within stated parameters.

DO NOT attach an additional energy absorbing lanyard or similar device between the SRD housing and the anchorage.

#### 5.3.2 Fall Arrest Impact Indicator:

The primary fall arrest impact indicator is the load-indicating leg-end connector. The connector will display a red band if it has been subjected to fall arrest, or equal, forces, as shown in Figure 6, if the snap hook shows any sign of damage, remove the unit from service.

**Figure 6 - Inspecting SRL Load-Indicating Leg-End Connector**

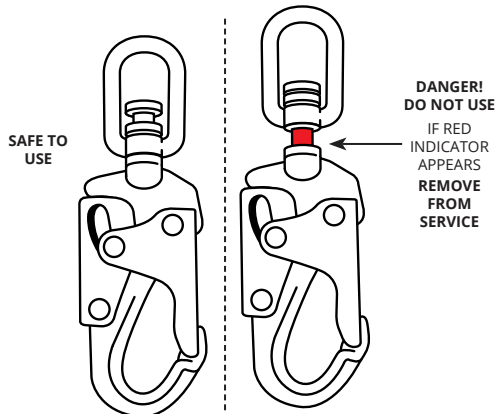

### 5.3.3 Lifeline Operational Limit and Reserve Indicators:

The SRD is equipped with two lifeline length indicators as shown in Figure 7; a green marker to indicate the end of the lifeline's working length, and a red marker, to indicate the reserve cable in the housing has been breached. When the SRD lifeline is extended to its operational limit, the lifeline will stop paying out. A green marker will be visible, as shown in Figure 7. The green marker, and a small portion of the lifeline past it, may become visible due to manufacturing variables during normal use, but the user will know when the operational end is reached. Do not attempt to pull out more lifeline. Extracting additional lifeline will compromise SRD functionality, and may result in serious injury or death.

If additional lifeline is accidentally pulled from the SRD without a fall event, remove the SRD from service and contact FallTech for options.

A red band is further up the lifeline. The red band, also shown in Figure 7, indicates the reserve portion of the lifeline has been breached. The SRD is no longer safe to use. Remove the SRD from service immediately, tag it as "UNUSABLE", and contact FallTech at [info@falltech.com](mailto:info@falltech.com).

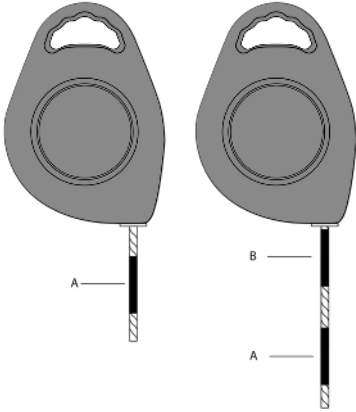

**Figure 7 - Inspecting SRD Line Indicators**

<b>A</b>	Green Indicator - Regular Safe Operating Condition of Cable Lifeline Length
<b>B</b>	Red Indicator - Reserve Line Unprotected; Remove SRD from Service

### 5.3.4 Inspect the Cable:

The SRD lifeline is steel cable, and subject to certain hazards. Inspect the lifeline before each use for the conditions as described in Section 7.

### 5.4 Using the SRD:

Do not use the SRD if inspection shows damage or any malfunction. Don the FBH in accordance with the FBH manufacturer's instructions. Follow the instructions contained in this manual and on the labels. Failure to follow instructions may result in serious injury or death. Connect the leg end snap hook to the dorsal D-ring on the FBH. Ensure the carabiner closes and locks. Attach the housing carabiner to the chosen anchorage and ensure the carabiner closes and locks. Ensure all connections are compatible. Normal operation will allow the working length of the lifeline to extend and retract as the worker moves about. A certain amount of tension must remain on the cable at all times to ensure proper operation of the internal brake. Do not allow the lifeline to become slack. If the lifeline becomes slack, remove the SRD from service for inspection. See Section 7.

Avoid sudden or quick movements during the normal work operation, as this may cause the SRD brake to engage and possibly cause loss of balance and injury or death.

If a fall occurs, the brake will engage and lock the lifeline to arrest the fall and limit arrest forces on the user.

- DO NOT extend the lifeline past the operational limit.
- DO NOT allow one SRD lifeline to become tangled or twisted with another SRD lifeline during use.
- DO NOT allow any lifeline to pass under arms or between legs during use.
- DO NOT clamp, knot, or prevent the lifeline from retracting or being taut.
- DO NOT lengthen the SRD by connecting a lifeline or similar component.
- DO NOT allow the lifeline to remain outside the housing when not in use.
- DO NOT allow the lifeline to freewheel back into the housing. Use a tag line to maintain tension and rewind the lifeline during periods of inactivity. Use the tag line to retrieve the leg end connector for the next use.
- DO NOT leave the tag line connected to the leg end connector when using the SRD for fall protection.

### **5.5 After A Fall:**

A fall event over an edge may require special rescue equipment and measures. Ensure a written rescue plan, method and system is in place and readily available to all users for rapid response. Ensure all users are trained in rescue procedures. If a fall event occurs, remove it from service, and store it separately. Remove from service any unit that has been subjected to fall arrest forces or that exhibits damage consistent with such forces. For questions, contact FallTech.

## **6.0 Maintenance, Service and Storage**

### **6.1 Maintenance:**

Ensure the SRD is kept free of excess paint, grease, dirt or other contaminants as this may cause to cable or retracting mechanism to malfunction. Ensure no debris enters the housing through the cable access port. Clean the exterior of the unit as required with a detergent/water solution. Do not allow water other corrosion causing elements to enter the housing. After cleaning, pull the lifeline all the way out, allow the unit to air dry, then retract the lifeline into the unit. Do not allow the lifeline to freewheel back into the housing. Clean labels as required.

- DO NOT use heat to dry.
- DO NOT attempt to disassemble the SRD.

### **6.2 Service:**

If service is required for any reason; inspection failure, impact loaded, any type of malfunction, tag the unit as "UNUSABLE", store separately, and contact FallTech at 323-752-0066 to receive a Return Authorization number or to locate the nearest FallTech Service Center. The SRD is not user repairable. Only the manufacturer, or a repair facility authorized in writing, may make repairs to the SRD. This SRD is designed to be used installed in an anchor cradle or attached overhead. While it may be used horizontally on a flat surface, the user may encounter a situation where the lifeline will not retract all the way due to misalignment and bunching up on the drum.

If this happens, hang the SRD from a height sufficient to allow the full working length of the lifeline to be pulled off the drum, then allow the SRD to retract the lifeline completely. Maintain tension on the lifeline. Use a tag line if necessary.

### **6.3 Storage:**

Hang the SRD in a cool, dry, clean environment out of direct sunlight. Position the SRD so excess water can drain out. Avoid expo sure to chemical or caustic vapors. Thoroughly inspect the SRD after any period of extended storage.

## **7.0 Inspection**

### **7.1 Pre-Use User Inspection:**

Perform an inspection before each use in accordance with the recommendations in Table 1 below.

**Table 1 - Guidelines for Cable SRD Inspection**

Inspection Procedure	Pass	Fail
The cable lifeline should extract and retract completely and without faltering and should remain taut under tension without sagging.		
Extract the cable lifeline several inches and apply a firm pull to confirm the SRD locks. The locking should be certain and without skidding. Repeat this lockup at additional places along the lifeline length to confirm the SRD is operating correctly.		
Examine the load indicator on the swiveling carabiner to be certain that it has not been loaded, impacted or activated. (see figure 6A if needed)		
Inspect the entire length of the constituent line up to the Green Maximum Working Length Visual Indicator shown in Figure 13. Review the cable lifeline closely for broken strand wires, welding spatter burns, welding slag, birdcaging, kinks and bent strands. Also examine for rust, dirt, paint, grease or oil. Check for damage caused by chemical corruption or excessive heat as evident with discoloration. See Figure 6 for examples. If any of these conditions exist, remove the SRD from service.		
If during your line inspection defined above, you extract the line past the Green Indicator and ultimately expose a secondary Red Indicator on the line, you must remove the SRD from service immediately. This Secondary Red Visual Indicator signals the SRD unit's Reserve Line has been deployed or the SRD has experienced a fall event and is no longer in working order.		
Check for any missing or loose screws or nuts and any deformed or damaged components.		
Examine the external housing for cracks, breaks or warping.		
Check the external Connector Eye and the Anchorage Carabiner for damage and deformation. The Anchorage Carabiner Gate should twist open and snap shut easily and smoothly.		
Examine the overall SRD unit for any indications of deterioration or damage.		
All labels must be intact and totally readable (see Section 8) APPENDIX A		

**Figure 8: Inspection of Cable**

Extract all of the cable and check the entire working length for damage caused by chemical corruption or excessive heat as evident by discoloration (A), birdcaging (B), broken wire strands (C), kinks and bent strands (D), see Figure 8. The cable should retract completely without faltering and should remain taut under tension without sagging.

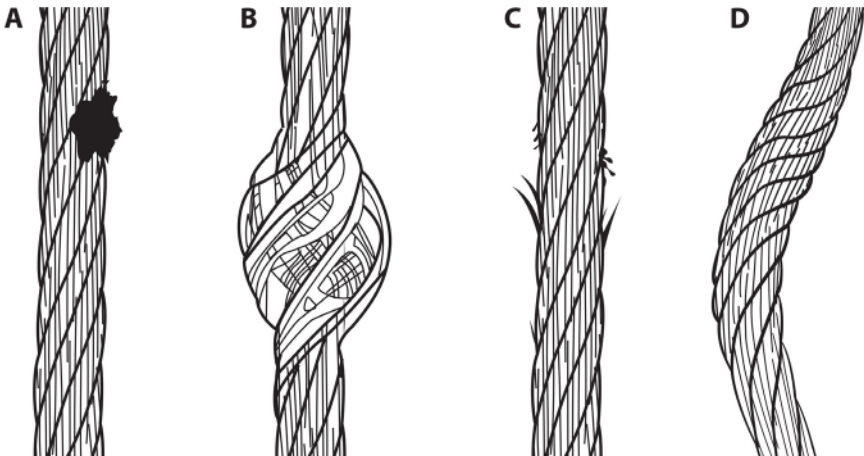

## 7.2 Inspection Frequency:

Inspection by a competent person at regular intervals is required. The competent person will use the information in Table 2: SRD Inspection Recommendations, to determine the inspection frequency. Use Table 2 to determine the inspection frequency. Inspection by a factory authorized inspection entity at regular intervals is also required.

<b>Table 2 - ANSI Z359.14-2014 SRD Inspection Recommendations</b>			
<b>Type of Use</b>	<b>Application Examples</b>	<b>Conditions of Use</b>	<b>Inspection Frequency Competent Person</b>
<b>Infrequent to Light Use</b>	Rescue and Confined Space, Factory Maintenance	Good Storage Conditions, Indoor or Infrequent Outdoor use, Room Temperature, Clean Environments	<b>Annually</b>
<b>Moderate to Heavy Use</b>	Transportation, Residential Construction, Utilities, Warehouse	Fair Storage Conditions, Indoor and extended outdoor use, All temperatures, Clean or dusty environments	<b>Semi-annually to Annually</b>
<b>Severe to Continuous Use</b>	Commercial Construction, Oil and Gas, Mining	Harsh Storage Conditions, Prolonged or Continuous outdoor Use, all temperatures, Dirty environments	<b>Quarterly to Semi-annually</b>

## 7.3 Inspection Checklist:

Use Table 1: Guidelines for Cable SRD Inspection to inspect the SRD. See Figure 8 for examples of cable damage.

## 7.4 Inspection Results:

If an inspection reveals defects in or damage to the equipment, inadequate maintenance or activated fall indicators, remove the equipment from service.

## 7.5 Inspection Document:

Record inspection results on the Inspection Record provided on the following page or on a similar document.



## 8.0 Labels

Product labels must be present and legible.



**WARNING**

Always read and follow the manufacturer's instructions, labels and warnings before use. Failure to do so can result in serious injury or death. If unit is subjected to a fall, remove from service immediately. Before each use, test the device for locking and retraction, and inspect according to the manufacturer's instructions. Ensure adequate clearance exists in fall zone to avoid contact with lower level or obstruction. Limit swing falls by working directly beneath anchor. Exposure to sharp or serrated structural edges could damage the lifeline. Elevate anchorage to limit risk of damage or failure, and to reduce clearance requirements. SRL must be installed onto the worker's full body harness. Adhere to the hierarchy of controls described in ANSI Z359.2 Suitable for horizontal use and for use with horizontal lifelines. Do not connect to an anchor below the dorsal D-ring.

<b>ANSI Z359.14-2021 Compliant</b>		<b>Maximum Free-fall: 2 ft.</b>	
Length: <input type="checkbox"/> 15FT	<input type="checkbox"/> 20FT	<input type="checkbox"/> 25FT	<input type="checkbox"/> 30FT
<input type="checkbox"/> 40FT	<input type="checkbox"/> 50FT	<input type="checkbox"/> 60FT	<input type="checkbox"/> FT
Part # / Date of Manufacture: See Brass Tag Serial Number: See Brass Tag See instruction manual for minimum anchorage strength requirements			
<b>SAFE TO USE</b>		<b>DANGER! DO NOT USE</b> IF RED LOAD INDICATOR APPEARS	
			
<b>DO NOT REMOVE LABEL</b>			

## 9.0 Definitions

The following are general definitions of fall protection terms as defined by ANSI Z359.0-2012.

### **Anchorage:**

A secure connecting point or a terminating component of a fall protection system or rescue system capable of safely supporting the impact forces applied by a fall protection system or anchorage subsystem.

### **Anchorage Connector:**

A component or subsystem that functions as an interface between the anchorage and a fall protection, work positioning, rope access or rescue system for the purpose of coupling the system to the anchorage.

### **Arrest Distance :**

The total vertical distance required to arrest a fall. The arrest distance includes the deceleration distance and activation distance.

### **Authorized Person:**

A person assigned by the employer to perform duties at a location where the person will be exposed to a fall hazard.

### **Available Clearance:**

The distance from a reference point, such as the working platform, to the nearest obstruction that an authorized person might contact during a fall which, if struck, could cause injury.

### **Capacity:**

The maximum weight that a component, system or subsystem is designed to hold.

### **Certification:**

The act of attesting in writing that the criteria established by these standards or some other designated standard have been met.

### **Certified Anchorage:**

An anchorage for fall arrest, positioning, restraint or rescue systems that a qualified person certifies to be capable of supporting the potential fall forces that could be encountered during a fall.

### **Clearance:**

The distance from a specified reference point, such as the working platform or anchorage of a fall arrest system, to the lower level that a worker might encounter during a fall.

### **Clearance Requirement:**

The distance below an authorized person that must remain clear of obstructions in order to ensure that the authorized person does not make contact with any objects that would cause injury in the event of a fall.

### **Competent Person:**

An individual designated by the employer to be responsible for the immediate supervision, implementation and monitoring of the employer's managed fall protection program who, through training and knowledge, is capable of identifying, evaluating and addressing existing and potential fall hazards, and who has the employer's authority to take prompt corrective action with regard to such hazards.

### **Component :**

An element or integral assembly of interconnected elements intended to perform one function in the system.

### **Connecting Subsystem:**

An assembly, including the necessary connectors, comprised of all components, subsystems, or both, between the anchorage or anchorage connector and the harness attachment point.

### **Connector:**

A component or element that is used to couple parts of the system together.

**Deceleration Distance:**

The vertical distance between the user's fall arrest attachment at the onset of fall arrest forces during a fall, and after the fall arrest attachment comes to a complete stop.

**Energy (Shock) Absorber:**

A component whose primary function is to dissipate energy and limit deceleration forces which the system imposes on the body during fall arrest.

**Fall Arrest:**

The action or event of stopping a free fall or the instant where the downward free fall has been stopped.

**Fall Hazard:**

Any location where a person is exposed to a potential free fall.

**Free Fall:**

The act of falling before a fall protection system begins to apply forces to arrest the fall.

**Free Fall Distance:**

The vertical distance traveled during a fall, measured from the onset of a fall from a walking working surface to the point at which the fall protection system begins to arrest the fall.

**Harness, Full Body:**

A body support designed to contain the torso and distribute the fall arrest forces over at least the upper thighs, pelvis, chest and shoulders.

**Horizontal Lifeline:**

A component of a horizontal lifeline subsystem, consisting of a flexible line with connectors or other coupling means at both ends for securing it horizontally between two anchorages or anchorage connectors.

**Horizontal Lifeline Subsystem :**

An assembly, including the necessary connectors, comprised of a horizontal lifeline component and, optionally, of: a) An energy absorbing component or, b) A lifeline tensioner component, or both. This subsystem is normally attached at each end to an anchorage or anchorage connector. The end anchorages have the same elevation.

**Lanyard:**

A component consisting of a flexible rope, wire rope or strap, which typically has a connector at each end for connecting to the body support and to a fall arrester, energy absorber, anchorage connector or anchorage.

**Lanyard Connecting Subsystem :**

An assembly, including the necessary connectors, comprised of a lanyard only, or a lanyard and energy absorber.

**Personal Fall Arrest System (PFAS) :**

An assembly of components and subsystems used to arrest a person in a free fall.

**Positioning :**

The act of supporting the body with a positioning system for the purpose of working with hands free.

**Positioning Lanyard:**

A lanyard used to transfer forces from a body support to an anchorage or anchorage connector in a positioning system.

**Qualified Person :**

A person with a recognized degree or professional certificate and with extensive knowledge, training and experience in the fall protection and rescue field who is capable of designing, analyzing, evaluating and specifying fall protection and rescue systems.

**Self-Retracting Device (SRD):**

A device that contains a drum wound line that automatically locks at the onset of a fall to arrest the user, but that pays out from and automatically retracts onto the drum during normal movement of the

person to whom the line is attached.

After onset of a fall, the device automatically locks the drum and arrests the fall. Self-retracting devices include self-retracting lanyards (SRLs), self-retracting lanyards with integral rescue capability (SRL-Rs), and self-retracting lanyards with leading edge capability (SRL-LEs) and, hybrid combinations of these.

**Snaphook:**

A connector comprised of a hook-shaped body with a normally closed gate or similar arrangement that may be opened to permit the hook to receive an object and, when released, automatically closes to retain the object.

**Swing Fall :**

A pendulum-like motion that occurs during and/or after a vertical fall. A swing fall results when an authorized person begins a fall from a position that is located horizontally away from a fixed anchorage.

APPENDIX A

**Table 1A: Specifications for DuraTech SRL**

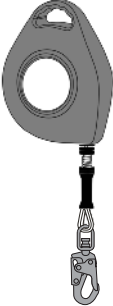
Model #	Constituent	Working Length, Weight, and Housing Size	Materials and Specifications	Capacity and Standards	Image
7227C (20') 7229C (25') 7232C (30')	7/32" Diameter Galvanized Steel Cable	20 ft / 25 ft / 30 ft (6.1m / 7.6m / 9.1m)	Housing: Cast Aluminum  Anchorage Carabiner: Plated Alloy Steel 5,000 lbs (22.2 kN) with 3,600 lbs (16 kN) Gate Strength  Load-Indicating Swivel Snap Hook: Plated Alloy Steel 5,000 lbs (22.2 kN) with 3,600 lbs (16 kN) Gate Strength	Single User Capacity: 130 to 310 lbs. (59 to 141 kg)  <b>ANSI Z359.14-2021 Class 1 SRL</b>  <b>OSHA 1926.502</b> <b>OSHA 1910.140</b>	
7268C (50') 7265C (60')		50 ft / 60 ft 15.2m / 18.3m			

**Table 1B: FallTech DuraTech Cable Class 1 SRL Performance Attributes**

Part #s and Conditions		Typical FallTech Performance			ANSI Performance Requirements		
Part #	Anchorage Condition	Arrest Distance	Average Arrest Force	Maximum Arrest Force	Maximum Arrest Distance	Average Arrest Force *Conditioned	Maximum Arrest Force
7227C 7229C 7232C	Overhead, Non-Leading Edge	27.0" (0.7 m)	888 lbf (4.0 kN)	1,319 lbf (5.9 kN)	42" (1.1 m)	1,575 lbs (7.0 kN)	1,800 lbs (8.0 kN)
7268C 7265C		29.2" (0.75 m)	1,008 lbf (4.5 kN)	1,762 lbf (7.8 kN)			