

10K Rotating Anchor for Steel

User Instruction Manual

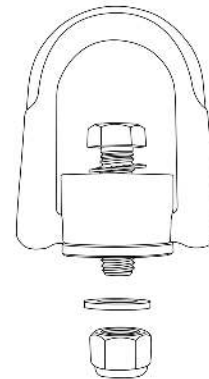
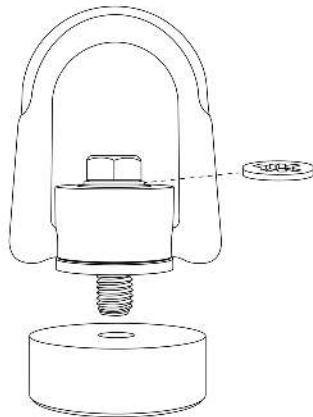
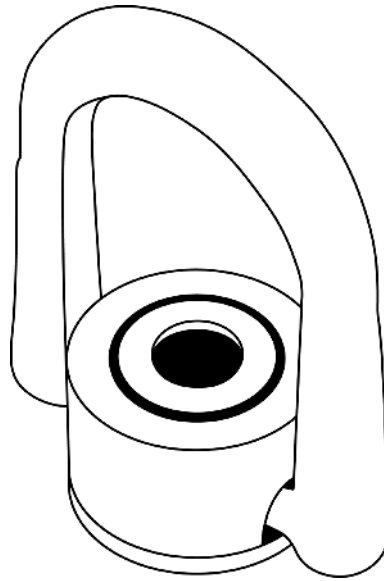

This manual is intended to meet the Manufacturer's Instructions as required by the American National Standards Institute (ANSI) Z359 and Canadian Standards Association (CSA) Z259 and should be used as part of an employee training program as required by the Occupational Safety and Health Administration (OSHA).

Table of Contents

1.0	Warnings and Important Information	3
2.0	Description	4
3.0	Application	4
4.0	System Requirements	5
5.0	Installation and Use	6
6.0	Maintenance, Service and Storage	8
7.0	Inspection	8
8.0	Labels	10
	Appendix A	11

For the purposes of this manual, FallTech 10k Rotating Anchor may be referred to as the anchor, anchorage connector, product, equipment, or as the unit.

1.0 Warnings and Important Information

WARNING

- Avoid moving machinery, thermal, electrical, and/or chemical hazards as contact may cause serious injury or death.
- Avoid swing falls.
- Follow the weight restrictions and recommendations in this manual.
- Remove from service any equipment subjected to fall arrest forces.
- Remove from service any equipment that fails inspection.
- Do not alter or intentionally misuse this equipment.
- Consult FallTech when using this equipment in combination with components or subsystems other than those described in this manual.
- Do not connect rebar hooks, large carabiners, or large snap hooks to the FBH dorsal D-rings as this may cause a roll-out condition and/or unintentional disengagement.
- Avoid sharp and/or abrasive surfaces and edges.
- Use caution when performing arc welding. Arc flash from arc welding operations, including accidental arcs from electrical equipment, can damage equipment and are potentially fatal.
- Examine the work area. Be aware of the surroundings and workplace hazards that may impact safety, security, and the functioning of fall arrest systems and components.
- Hazards may include but not be limited to cable or debris tripping hazards, equipment failures, personnel mistakes, moving equipment such as carts, barrows, fork lifts, cranes, or dollies. Do not allow materials, tools or equipment in transit to contact any part of the fall arrest system.
- Do not work under suspended loads.

IMPORTANT

This product is part of a personal fall arrest, restraint, work positioning, suspension, or rescue system. A Personal Fall Arrest System (PFAS) is typically composed of an anchorage and a Full Body Harness (FBH), with a connecting device, i.e., an Energy Absorbing Lanyard (EAL), or a Self-Retracting Device (SRD), attached to the dorsal D-ring of the FBH.

These instructions must be provided to the worker using this equipment. The worker must read and understand the manufacturer's instructions for each component or part of the complete system. Manufacturer's instructions must be followed for proper use, care, and maintenance of this product. These instructions must be retained and be kept available for the worker's reference at all times. Alterations or misuse of this product, or failure to follow instructions, may result in serious injury or death.

A Fall Protection Plan must be on file and available for review by all workers. It is the responsibility of the worker and the purchaser of this equipment to assure that users of this equipment are properly trained in its use, maintenance, and storage. Training must be repeated at regular intervals. Training must not subject the trainee to fall hazards.

Consult a doctor if there is reason to doubt your fitness to safely absorb the shock of a fall event. Age and fitness seriously affect a worker's ability to withstand falls. Pregnant women or minors must not use this equipment.

Heavy users experience more risk of serious injury or death due to falls because of increased fall arrest forces placed on the user's body. In addition, the onset of suspension trauma after a fall even may be accelerated for heavy users.

The user of the equipment discussed in this manual must read and understand the entire manual before beginning work.

NOTE: For more information consult the ANSI Z359 or CSA Z259 body of standards.

2.0 Description

The FallTech® 10k Rotating Anchor is a zinc-plated steel fall protection anchorage connector that has a rotating, self-orienting D-ring designed for use in steel applications. Whether using bolt-through or weld-on methods, the FallTech 10k rotating anchor is designed for use in PFAS, restraint, work positioning, suspension applications, or with FallTech horizontal lifeline systems, see Figure 1.

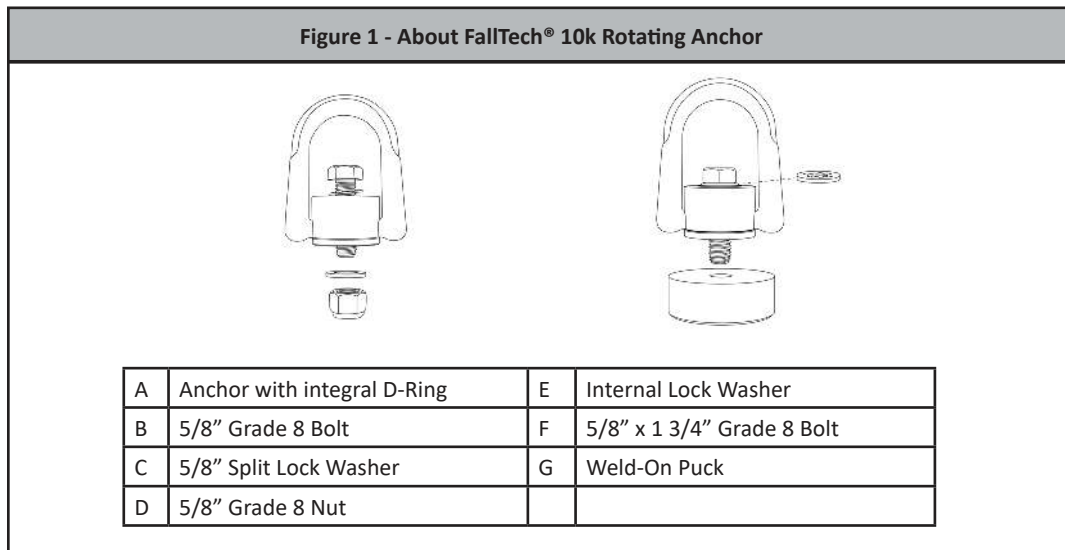

⚠ **WARNING**

Be sure to read, understand, and follow all instructions and warnings in this manual.
Any misuse could result in serious injury or death.

3.0 Application

3.1 Purpose: The purpose of the 10k Rotating Anchor is to provide a versatile multi-directional fall protection single point anchorage connector in steel applications wherein an ANSI/OSHA Personal Fall Arrest System, Restraint, Work Positioning, and Suspension system is necessary to protect against fall hazards. Additionally, two of the anchors may be used with select FallTech Horizontal Lifeline Systems to create an anchorage system designed for the connection of more than one worker to the system. The 10K Rotating Anchor is designed to be attached to steel surfaces by bolting either to or through steel. For non-bolted applications, a steel adapter puck is welded to the anchor surface and the 10k Rotating Anchor anchorage connector is bolted to the puck. When correctly installed the anchor has a maximum rated strength of 10,000 lbs. See Figure 2.

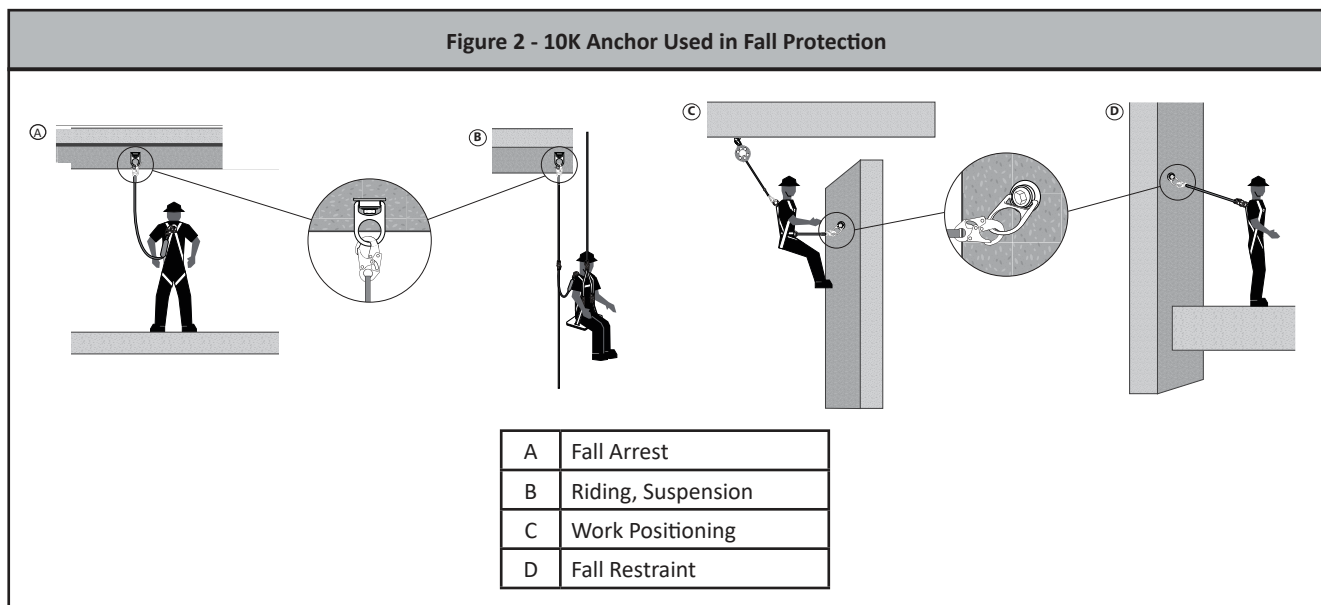

3.2 Bolt-through Application: Bolt-through applications typically occur on steel plate or I-beams of strength enough to meet with the requirements of Section 3. The 10k Rotating Anchor may be installed in vertically or horizontally and is designed to both rotate and swivel in the direction of the load. When bolting the anchor in place care should be taken to use the provided fastener and/or a minimum 5/8" x 4" Grade 8 bolt. When attaching to I-beams with tapered flanges a tapered washer should be used. The attachment bolt should be torqued to the ft-lbs. requirements specified in this manual.

3.3 Weld-on Application: Weld-on applications entail the installation of a round steel puck that has been pre-drilled and tapped to receive the provided 5/8"-11 Grade 8 Steel Hex Head Cap Screw that is 1.75" in length. The puck has been specifically machined for the attachment of the 10K Rotating anchor and is delivered with a chamfered side for welding the puck in place.

3.4 Horizontal Lifeline (HLL) Applications: The anchor detailed in this manual has been designed and tested to accommodate the attachment of horizontal lifelines. A single span horizontal lifeline may be attached between two properly installed anchors. The ultimate tensile strength of the 10k Rotating Anchor exceeds 10,000 lbs. In all cases of horizontal lifeline system attachment, a minimum 2 to 1 safety factor must be maintained. Horizontal lifelines attached to these anchors must have known end loads not to exceed 5,000 lbs. FallTech HLL systems may be attached between two properly installed 10k Rotating Anchors. Refer to the User's Instruction Manual specific to the HLL system to be installed to ensure proper installation of the HLL system.

3.5 Personal Fall Arrest System: A PFAS is typically composed of an anchorage and a FBH, with an energy absorbing connecting device, i.e., a EAL, an SRD, or a Fall Arrester Connecting Subsystem (FACSS), attached to the dorsal D-ring of properly fitted and adjusted FBH. All uses and applications of a FBH with this equipment requires the FBH to be properly fitted and adjusted to the user. Failure to properly fit the FBH to the user could result in serious injury or death.

3.6 Application Limits: The 10k rotating anchor is a multi-purpose anchor designed for single user attachment of a PFAS, restraint, work-positioning or suspension system. Unless a properly install HLL system is attached between two anchors, no more than one user may be attached the anchor.

3.6.1 Use Limitations and Warnings:

- a) Capacity of substrate should be verified by a Qualified Person prior to installation of anchor.
- b) Proper installation should be verified by a Competent Person before use. See Section 5.
- c) Anchor is designed for use in temperatures between -40 degrees F and 130 degrees F.
- d) Care should be taken when using the anchor to avoid moving machinery, electrical hazards, sharp edges, abrasive surfaces, and corrosive environments.
- e) Anchor should be used for fall protection only and is not meant for material handling.
- f) Labels should be present and legible.

3.6.2 Connecting Components:

- a) All connections to the anchorage connector must be made with compatible connecting components that comply with ANSI Z359.12.
- b) Large throat opening connectors such as rebar hooks and large carabiners may be connected only when the 10k Rotating Anchor is installed above the user's full body harness dorsal D-ring and must be installed in such a manner that the load during a fall event shall be applied along the major axis of the connector.
- c) No more than one connector shall be attached to the anchor at a time.
- d) Connectors shall be oriented in such a manner that the gate of the connector is free of potential impact or damage during a fall event.

3.6.3 Rescue: The equipment described in this manual is not specifically designed for rescue but may be included as part of a rescue plan. A rescue plan should be established by a Competent Person prior to use of this equipment.

4.0 System Requirements

4.1 Capacity: The anchor discussed in this manual is rated for a maximum total combined (clothing, tools, etc.) user weight of 425 lbs. Heavyweight users are cautioned. A user weighing 425 lbs. will experience very high fall arrest forces during a fall event. After a fall event, suspension trauma may rapidly develop. Users are advised to deploy suspension trauma relief equipment as soon as possible after a fall event. To maintain ANSI Z359 compliance, limit user weight to between 130 lbs. to 310 lbs. (58.9-140.6 kg), including clothing, tools, etc.

4.2 Compatibility of Connectors: Connectors are considered to be compatible with connecting elements when they have been designed to work together in such a way that their sizes and shapes do not cause their gate mechanisms to open inadvertently regardless of how they become oriented. Contact FallTech® if you have any questions about compatibility. Connectors must be compatible with the anchorage or other system components. Do not use equipment that is not compatible. Non-compatible connectors may unintentionally disengage Connectors must be compatible in size, shape, and strength. Self-closing, self-locking connectors are required by ANSI, CSA, and OSHA.

4.3 Making Connections: Only use self-locking connectors with this equipment. Only use connectors that are suitable to each application. Ensure all connections are compatible in size, shape, and strength. Do not use equipment that is not compatible. Visually ensure all connectors are fully closed and locked. Connectors (snap hooks, rebar hooks, and carabiners) are designed for use only as specified in this manual.

Figure 3 - Non-Compatible Connections

A	Never connect two active components (snap hooks or carabiners) to each other.
B	Never connect two active components (snap hooks or carabiners) to a single D-ring at the same time.
C	Never connect in a way that would produce a condition of loading on the gate.
D	Never attach to a object in a manner whereby the gate (of the snap hook or carabiner) would be prevented from fully closing and locking. Always guard against false connections by visually inspecting for closure and lock.
E	Never attach explicitly to a constituent subcomponent (webbing, cable or rope) unless specifically provided for by the manufacturer's instructions for both subcomponents (snap hook or carabiner and webbing, cable or rope).
F	Never attach in a manner where an element of the connector (gate or release lever) may become caught on the anchor thereby producing additional risk of false engagement.
G	Never attach a spreader snap hook to two side/positioning D-rings in a manner whereby the D-rings will engage the gates; the gates on a spreader must always be facing away from the D-rings during work positioning.

4.5 Personal Fall Arrest System: PFAS used with this equipment must meet ANSI Z359 requirements. A full body harness must be worn when this equipment is used as a component of a PFAS. As required by OSHA, the personal fall arrest system must be able to arrest the user's fall with a maximum arresting force of 1,800 lbs (8 kN), and limit the free fall to 6 ft (1.8 m).

4.6 Personal Fall Arrest System Anchorage Strength: PFAS Anchorage Strength: An anchorage selected for PFAS must have a strength able to sustain a static load applied in the direction permitted by the PFAS of at least:

- a. Two times the maximum arrest force permitted when certification exists, or
- b. 5,000 lbs. (22.2 kN) in the absence of certification.

Select an anchorage location carefully. Consider structural strength, obstructions in the fall path, and swing fall hazards. In certain situations, the qualified person can determine that a given structure is able to withstand the applied MAF of the PFAS with a safety factor of at least two.

5.0 Installation and Use

WARNING

Do not alter or intentionally misuse this equipment. Consult FallTech® when using this equipment in combination with components or subsystems other than those described in this manual. All components or subsystems used with the anchors discussed in this manual must be in compliance with ANSI Z359.

Take action to avoid sharp and/or abrasive surfaces and edges when possible.

5.1. Plan the Personal Fall Arrest System (PFAS): Examine the work area and take action to address hazards. Falls are a serious hazard when working at height. Training and equipment are the tools of fall hazard management. There are several closely related facets of fall hazard management with a PFAS;

- Anchorage
- Minimum Required Fall Clearance (MRFC)
- Swing Fall and Expanded Work Zone
- Overhead (above the FBH D-ring) Anchorage
- Non-overhead (below the FBH D-ring) Anchorage
- Rescue Plan

5.2 Anchorage: Select a suitable anchor point. See Section 4.6. To avoid an unintended disengagement of connectors, use only compatible connectors when connecting to the anchorage. Ensure all connectors close and lock securely.

5.3 Minimum Required Fall Clearance: The MRFC is the minimum distance a user needs between himself and the nearest obstruction (or ground) below the walking/working surface to avoid serious injury or death in case of a fall event. The user of this equipment must determine the MRFC for units discussed in this manual to ensure adequate clearance exists in the fall path. Variables discussed in this manual include the height of the anchor point relative to the user's FBH D-ring, i.e., overhead, see Lanyard example in Figure 3.

- 5.4 **Swing Fall:** A swing fall occurs when the worker moves laterally out from under the anchor and creates an expanded work zone condition. If a fall event occurs, the worker would swing back toward the anchorage, see Figure 4. The swinging action generates considerable force, and if the worker strikes an obstruction or the lower level, this force could cause severe injury or death.

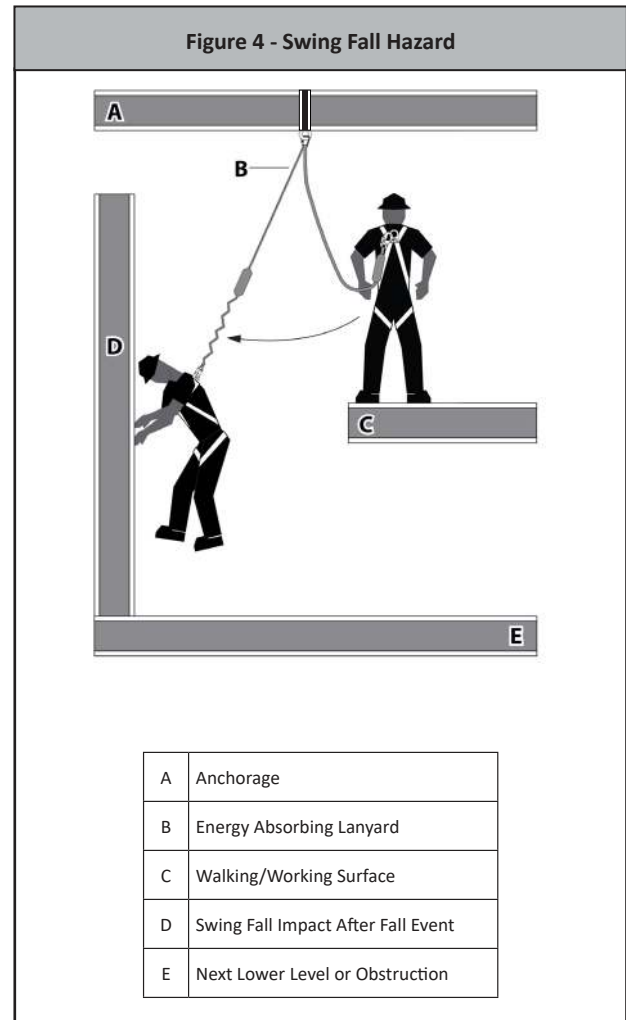
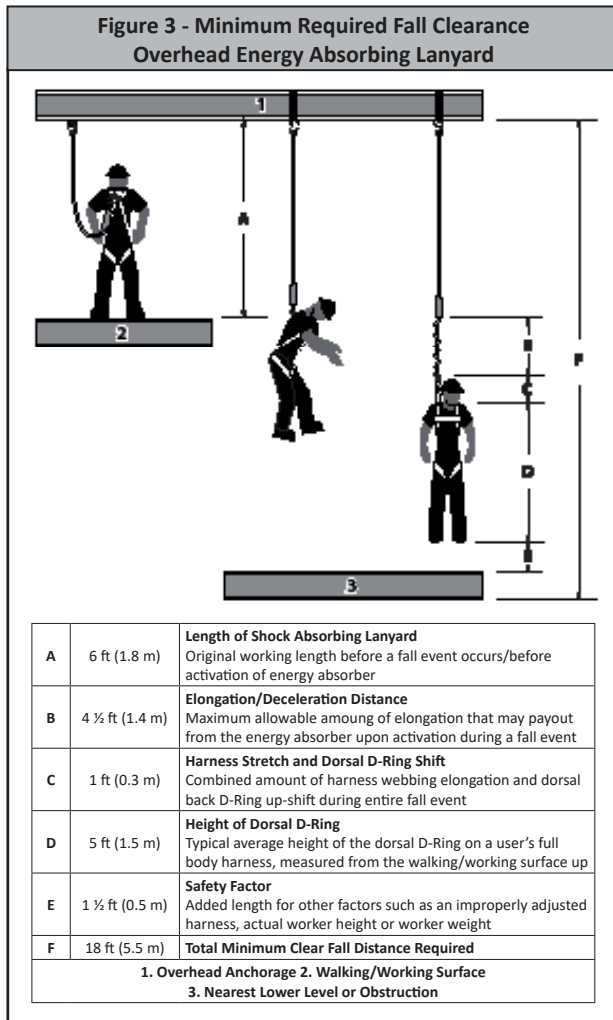

- 5.5 **Product Assembly and Installation:** The 10k Rotating Anchor may be installed on steel surfaces either by bolting through or welding to a steel surface. The installation procedures detailed in this section must be adhered to for proper installation. Failure to follow the installation instructions could a failure of the anchor during a fall event and result in serious injury or death.

5.5.1 Bolt-through Steel Installation:

Minimum Hardware Requirements:

- 1) 5/8"-11 Grade 8 Steel Hex Head Cap Screw (HHCS), minimum length 4"
- 2) 5/8"-11 Grade 8 Locking Hex Nut
- 3) 5/8" Lock Washer or Equivalent

Minimum Steel Surface Requirements:

- 1) 3/4" minimum steel plate thickness
- 2) 3" minimum edge distance
- 3) 5,000 to 10,000 lb. load rated structure depending on application (If installing for HLL, use ensure minimum 2 to 1 safety factor)

Installation Instructions:

- 1) Drill 5/8" hole perpendicular to the steel surface and at least 3" away from any edge of steel.
- 2) Fasten the rotating anchor to the steel surface using the appropriate hardware.
- 3) Torque the bolt to 75 ft-lbs. Do not exceed 90 ft-lbs.
- 4) Rotating anchor must be flush with steel surface when installed.

*If necessary, use tapered washers with I-beams that have tapered flanges.

5.2.2 Weld-on Installation:

Minimum Hardware Requirements:

- 1) 5/8"-11 Grade 8 Steel Hex Head Cap Screw (HHCS), 1.75" Length
- 2) 5/8" Internal Tooth Lock Washer

Minimum Steel Surface Requirements:

- 1) 3/8" steel plate thickness
- 2) 5,000 to 10,000 lb. load rated structure depending on application (If installing for HLL, use ensure minimum 2 to 1 safety factor)

Installation Instructions:

- 1) Place chamfered side of Weld-on Puck face down on the steel surface.
- 2) Performed by an AWS certified welder
- 3) Weld the puck onto steel surface (Minimum 3/8" Fillet)
- 4) Ensure that the weld bead flows into the puck's chamfer.
- 5) Fasten the rotating anchor to the welded-on puck using the provided hardware. Torque the bolt to 75 ft-lbs. Do not exceed 90 ft-lbs.

6.0 Maintenance, Service, and Storage

6.1 Maintenance: No maintenance required, if unit appears damaged, has been subjected to fall forces or does not pass inspection, remove it from service.

6.2 Service: There are no specific service requirements for this anchorage.

6.3 Storage: If the unit is removed from its installation location it should be stored in a dry area free of corrosive elements that may harm or cause it not to function.

7.0 Inspection

7.1 Pre-Use Inspection: The anchor should be inspected for the following:



- Cracks
- Bends
- Deformation
- Corrosion
- Product Labeling
- Pitting
- Torque
- Smooth operation of the rotating/swiveling D-ring.

7.2 Inspection Frequency: FallTech requires all fall protection equipment to be inspected by a Competent Person other than the user at least once each year or more frequently if the conditions exist. FallTech strongly recommends that a Competent Person conducts a hazard assessment of the environment and determines the length of the inspection intervals due to the site conditions. The annual inspection shall be recorded on an inspection log, including all deficiencies. This inspection should also be used as an opportunity to train any Authorized Persons with respect to deficiencies that they have failed to observe on their daily inspections.

Inspection Frequency				
Type of Use	Application Examples	Example Conditions of Use	Worker Inspection Frequency	Competent Person Inspection Frequency
Infrequent to Light Use	Rescue and confined space, factory maintenance	Good storage conditions, indoor or infrequent outdoor use, room temperature, clean environments	Before each use	Annually
Moderate to Heavy Use	Transportation, residential construction, utilities, warehouse	Fair storage conditions, indoor and extended outdoor use, all temperatures, clean or dusty environments	Before each use	Semi-annually to annually
Severe to Continuous Use	Commercial construction, oil and gas, mining, foundry	Harsh storage conditions, prolonged or continuous outdoor use, all temperatures, dirty environments	Before each use	Quarterly to semi-annually

7.3 Inspection Results: Should the anchor fail inspection it should be removed from service until deemed serviceable by a Competent or Qualified Person.

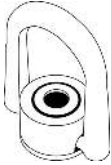
APPENDIX A

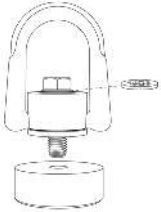
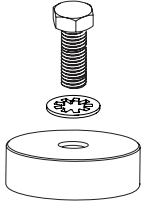
Table 1: Specifications for 10k Rotating Anchor					
FallTech Part #	Application	Dimensions	Minimum Tensile Strength and Material	Maximum User Capacity	Concrete Anchor and Fastener Sets
7393B Anchor-Only (User-supplied fastener)	Concrete Bolt-On				
7393BS Anchor with 5/8" x 4" Grade 8 Bolt and Nut	Steel Bolt-Thru	10k Rotating Anchor: 5½" x 3" x 1" 2¼" Inside Diameter D-Ring	10k Rotating Anchor: 10,000 lb Minimum Zinc Plated Alloy Steel	310 lbs to comply with ANSI Z359.1-2007 and OSHA 425 lbs to comply with OSHA only	
7393BW Anchor with Weld-on Puck and 5/8" x 1¼" Grade 8 Bolt	Steel Weld-on				
7393BP Weld-on Puck only with 5/8" x 1¼" Grade 8 Bolt	Steel Weld-on	3" x 1" Puck with 5/8" threaded hole	Unplated 1018 Mild Steel		
7393S1 Replacement Bolt and nut for 7393S	Steel Bolt-Thru	5/8 x 4" Grade 8 Bolt with 5/8" Grade 8 Nut	Zinc Plated Grade 8 Steel		