

**4-Person Temporary Horizontal Lifeline**  
**User Instruction Manual**

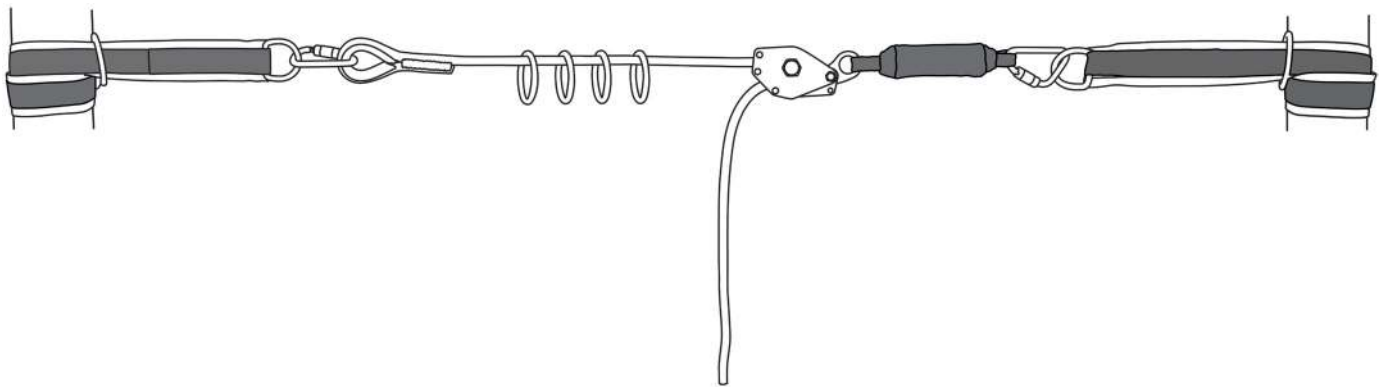

This manual is intended to meet the Manufacturer's Instructions as required by the American National Standards Institute (ANSI) Z359 and should be used as part of an employee training program as required by the Occupational Safety and Health Administration (OSHA).

## Table of Contents

1.0	Warnings and Important Information .....	3
2.0	Application .....	4
3.0	System Requirements .....	9
4.0	Installation and Use .....	10
5.0	Maintenance, Service and Storage .....	13
6.0	Inspection .....	13
7.0	Labels .....	14
	Appendix A .....	16

For the purposes of this manual, the FallTech 4-Person Temporary Horizontal Lifeline may be referred to as the FallTech 4-Person Temporary HLL, the Horizontal Lifeline, HLL, the system, or the lifeline.

## 1.0 Warnings and Important Information

### **WARNING**

- Avoid moving machinery, thermal, electrical, and/or chemical hazards as contact may cause serious injury or death.
- Avoid swing falls.
- Follow the weight restrictions and recommendations in this manual.
- Remove from service any equipment subjected to fall arrest forces.
- Remove from service any equipment that fails inspection.
- Do not alter or intentionally misuse this equipment.
- Consult FallTech when using this equipment in combination with components or subsystems other than those described in this manual.
- Do not connect rebar hooks, large carabiners, or large snap hooks to the FBH dorsal D-rings as this may cause a roll-out condition and/or unintentional disengagement.
- Avoid sharp and/or abrasive surfaces and edges.
- Use caution when performing arc welding. Arc flash from arc welding operations, including accidental arcs from electrical equipment, can damage equipment and are potentially fatal.
- Examine the work area. Be aware of the surroundings and workplace hazards that may impact safety, security, and the functioning of fall arrest systems and components.
- Hazards may include, but are not limited to, cable or debris tripping hazards, equipment failures, personnel mistakes, or moving equipment such as carts, barrows, fork lifts, cranes, or dollies. Do not allow materials, tools, or equipment in transit to contact any part of the fall arrest system.
- Do not work under suspended loads.

### **IMPORTANT**

This product is part of a personal fall arrest, restraint, work positioning, suspension, or rescue system. A Personal Fall Arrest System (PFAS) is typically composed of an anchorage and a Full Body Harness (FBH), with a connecting device, i.e., a Shock Absorbing Lanyard (SAL), or a Self-Retracting Lanyard (SRL), attached to the dorsal D-ring of the FBH.

These instructions must be provided to the worker using this equipment. The worker must read and understand the manufacturer's instructions for each component or part of the complete system. Manufacturer's instructions must be followed for proper use, care, and maintenance of this product. These instructions must be retained and be kept available for the worker's reference at all times. Alterations or misuse of this product, or failure to follow instructions, may result in serious injury or death.

A Fall Protection Plan must be on file and available for review by all workers. It is the responsibility of the worker and the purchaser of this equipment to assure that users of this equipment are properly trained in its use, maintenance, and storage. Training must be repeated at regular intervals. Training must not subject the trainee to fall hazards.

Consult a doctor if there is reason to doubt your fitness to safely absorb the shock of a fall event. Age and fitness seriously affect a worker's ability to withstand falls. Pregnant women or minors must not use this equipment.

ANSI limits the weight of fall protection equipment users to a maximum of 310 lbs. Products in this manual may have a rated capacity exceeding ANSI capacity limits. Heavy users experience more risk of serious injury or death due to falls because of increased fall arrest forces placed on the user's body. In addition, the onset of suspension trauma after a fall event may be accelerated for heavy users.

The user of the equipment discussed in this manual must read and understand the entire manual before beginning work.

NOTE: For more information consult the ANSI Z359 body of standards.

## 2.0 Application

- 2.1 The FallTech 4-Person Temporary HLL provides horizontal mobility for workers exposed to fall hazards and is designed as an anchorage subsystem for the attachment of up to four PFASs. The HLL is adjustable up to 100' in length for a single span system and is designed to be used as part of a complete PFAS. See Figure 1.

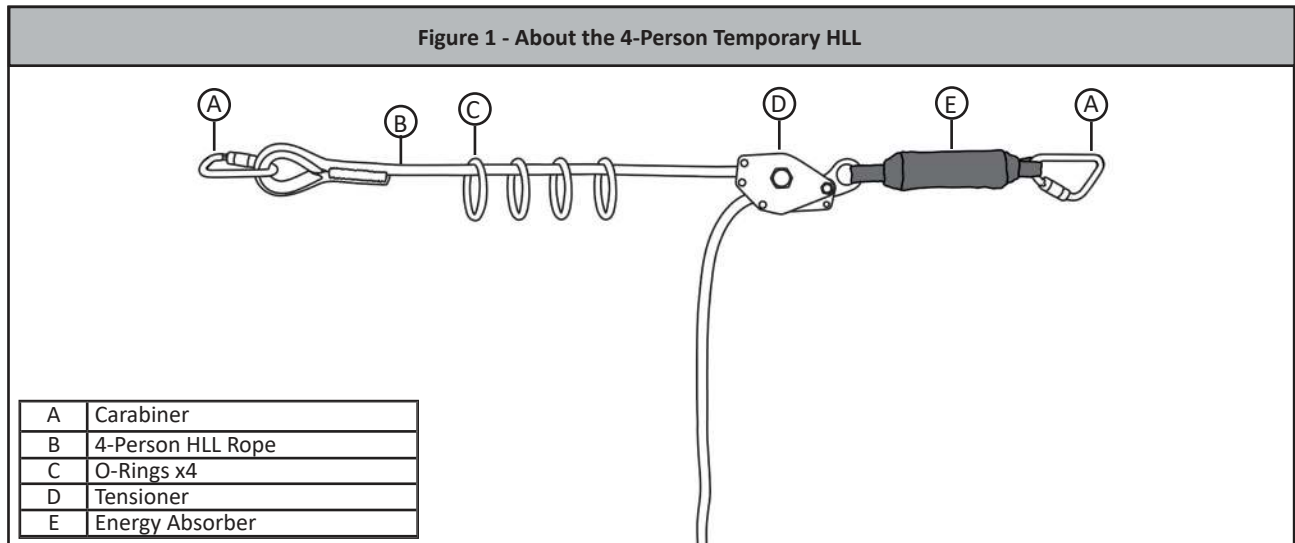

When properly tensioned, the lifeline will react to a fall event of up to four workers by combining the energy absorbing properties of the lifeline energy absorber, the lifeline, and the worker's personal energy absorber. During a fall event, the stretch of the lifeline and the expansion of the user's PFAS will result in reduced forces to the anchor and to the user's body.

- 2.2 **Application Limits:** The FallTech 4-Person Temporary HLL is a dynamic anchorage subsystem that will vary in its performance depending upon the length of the system, the number of workers attached and the type of PFAS being used. Care should be taken to understand the capacity of the system, minimum required fall clearance, anchorage strength requirements, total allowable free fall, total allowable fall clearance, and how the user's PFAS will deploy during a fall event. Longer HLL spans will generate more lifeline deflection and sag during a fall event and will result in greater clearance requirements. See Figure 2.

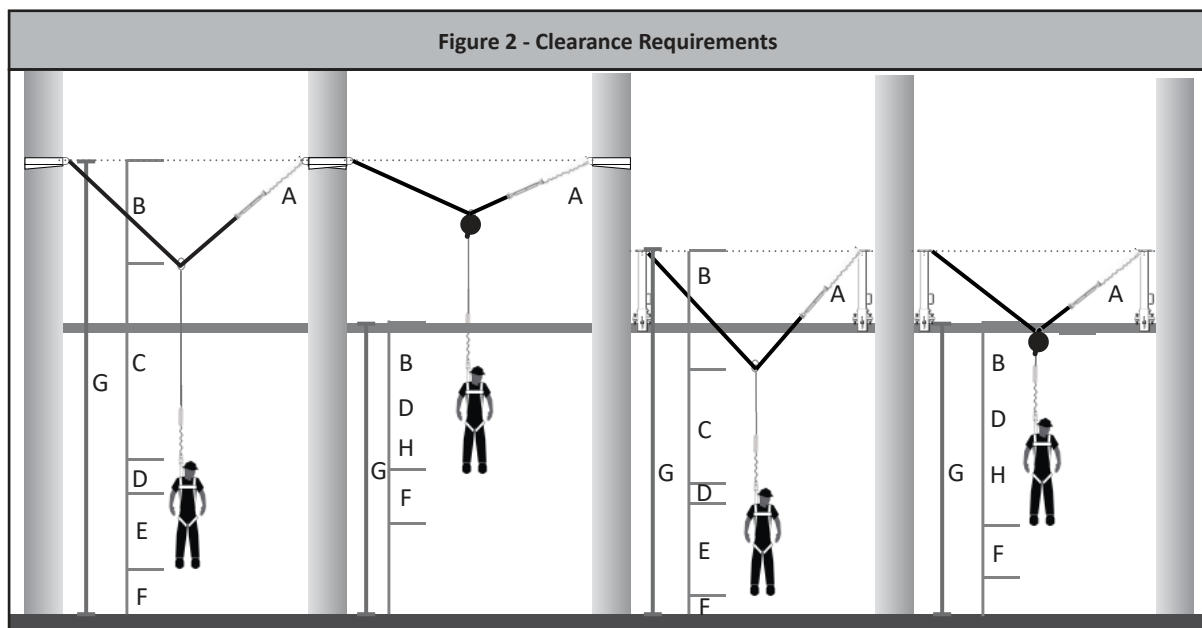

A	Deployed In-Line Energy Absorber	E	Height of Worker
B	Dynamic Lifeline Sag	F	Safety Factor
C	Deployed EAL	G	Total Required Fall Clearance
D	D-ring Shift and Harness Stretch	H	Total SRD Deceleration Distance from User's Manual*

\* If SRD Deceleration Distance is unknown in overhead applications, use 2 feet for ANSI Z359.14-2014 Class A SRDs, 4-1/2 feet for ANSI Z359.14-2014 Class B SRDs, or 3-1/2 feet for ANSI Z359.14-2021 Class 1 or 2 SRDs.

- 2.3 System Capacity:** The FallTech 4-Person Temporary HLL maximum capacity is four workers simultaneously, with each worker weighing no more than 310 lbs. inclusive of clothing, tools, etc.
- 2.4 Anchorage Requirements:** End anchors selected for use with this system must be a minimum of 5,000 lbs. (22.2 kN) for one and two workers and 6,000 lbs. (26.7 kN) for three and four workers. If used in applications with leading edge hazards, anchorage locations must be selected so that the deflected HLL shall not come in contact with a leading edge in the event of a fall.
- 2.5 Total Allowable Free Fall:** OSHA limits free fall to 6' or less. The HLL system described in this manual is designed to be used overhead and free fall should be limited to 6' unless otherwise specified by a specific anchorage solution.
- 2.6 PFAS Selection:** Only FallTech PFASs may be used in conjunction with this HLL system. The HLL may be used with FallTech energy absorbing lanyards, FallTech self-retracting devices and FallTech fall arrestor connecting subsystems.
- 2.7 Clearance Requirements:** The FallTech 4-Person Temporary HLL is designed to react to a fall event by elongating and deflecting to absorb energy. PFAS attached to the HLL will also elongate during a fall event. Failure to calculate the fall clearance required when using the system could result in contact with a lower level or obstruction during a fall event and could result in serious injury or death. See tables and charts below for calculating minimum required fall clearance.
- 2.7.1 Minimum Required Fall Clearance for One Worker w/EAL**

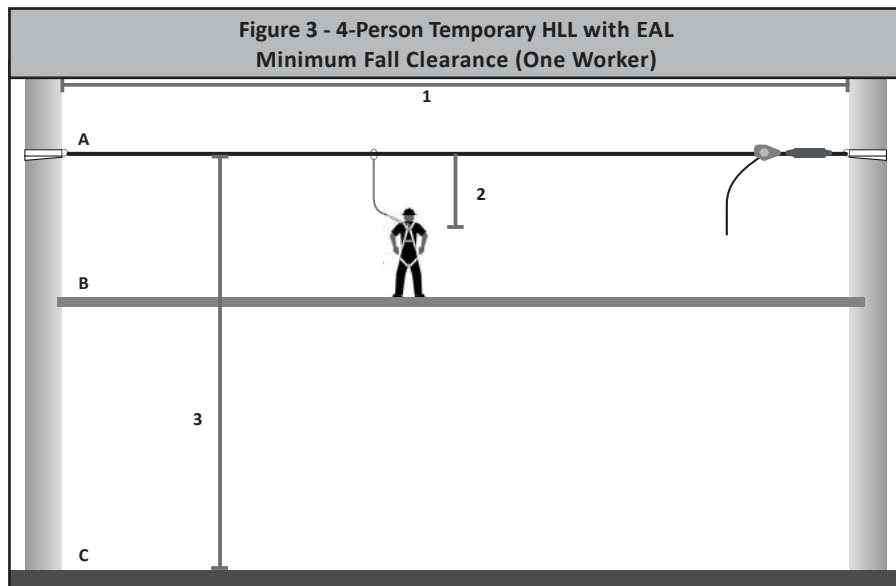

Temporary HLL with EAL Minimum Required Fall Clearance	
310 lbs. Maximum User Capacity	Max. One Worker
<b>1</b>	Find Span Length in Table Below
<b>2</b>	Find Freefall Distance in Table Below
<b>3</b>	Required Fall Clearance at the intersection of Span Length and Freefall Distance (see table below)
A. Overhead Anchorage    B. Walking/Working Surface    C. Nearest Lower Level or Obstruction	
* Work below HLL to avoid Swing Fall	

		Freefall Distance (feet)							
		0	1	2	3	4	5	6	7 *
Span Length (feet)	0 - 30	15.0'	16.0'	17.0'	18.0'	19.0'	20.0'	21.0'	22.0'
	31 - 40	16.0'	17.0'	18.0'	19.0'	20.0'	21.0'	22.0'	23.0'
	41 - 50	17.0'	18.0'	19.0'	20.0'	21.0'	22.0'	23.0'	24.0'
	51 - 60	17.5'	18.5'	19.5'	20.5'	21.5'	22.5'	23.5'	24.5'
	61 - 70	19.0'	20.0'	21.0'	22.0'	23.0'	24.0'	25.0'	26.0'
	71 - 80	20.0'	21.0'	22.0'	23.0'	24.0'	25.0'	26.0'	27.0'
	81 - 90	22.5'	23.5'	24.5'	25.5'	26.5'	27.5'	28.5'	29.5'
	91 - 100	23.5'	24.5'	25.5'	26.5'	27.5'	28.5'	29.5'	30.5'

\* 7' Freefall Distance scenario is only allowed when the FallTech 4-Person Temporary HLL is attached to the FallTech SteelGrip® Stanchion. Freefall should be limited to 6' or less when used with any other anchorage connector.

2.7.2 Minimum Required Fall Clearance for Two Workers w/EAL

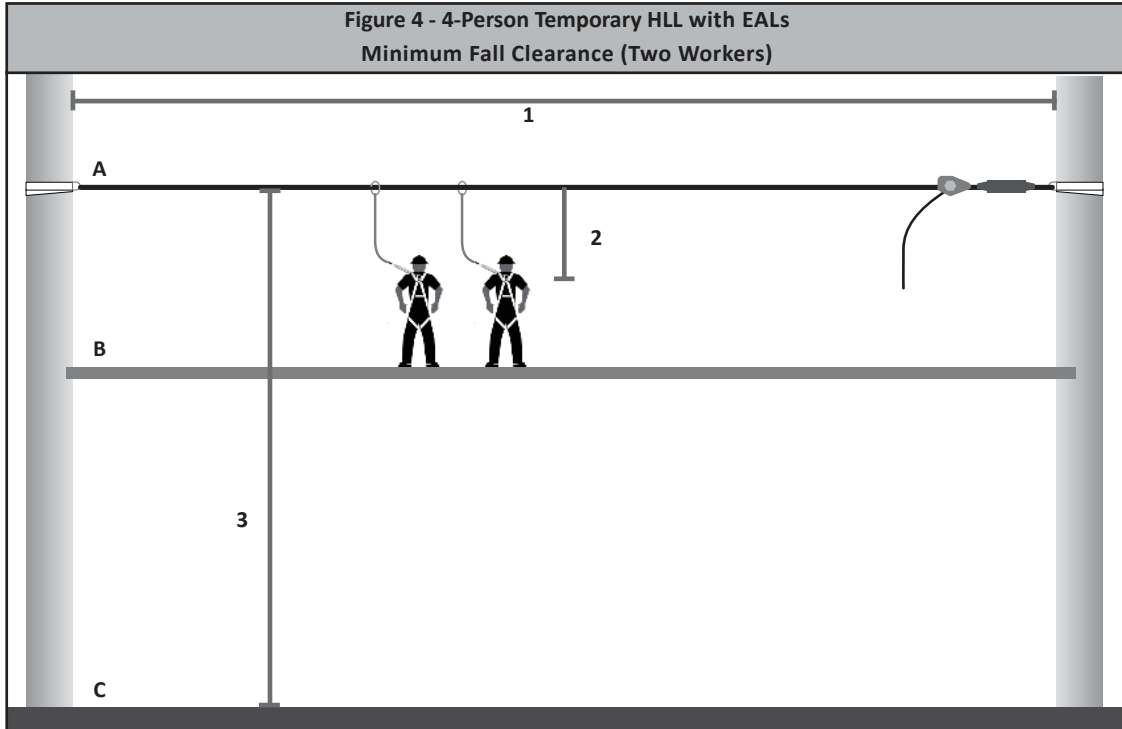

Temporary HLL with EAL Minimum Required Fall Clearance	
310 lbs. Maximum User Capacity Each	Max. Two Workers
1	Find Span Length in Table Below
2	Find Freefall Distance in Table Below
3	Required Fall Clearance at the intersection of Span Length and Freefall Distance (see table below)
A. Overhead Anchorage B. Walking/Working Surface C. Nearest Lower Level or Obstruction	
* Work below HLL to avoid Swing Fall	

Span Length (feet)	Freefall Distance (feet)							
	0	1	2	3	4	5	6	7 *
0 - 30	16.0'	17.0'	18.0'	19.0'	20.0'	21.0'	22.0'	23.0'
31 - 40	17.5'	18.5'	19.5'	20.5'	21.5'	22.5'	23.5'	24.5'
41 - 50	19.0'	20.0'	21.0'	22.0'	23.0'	24.0'	25.0'	26.0'
51 - 60	20.5'	21.5'	22.5'	23.5'	24.5'	25.5'	26.5'	27.5'
61 - 70	22.0'	23.0'	24.0'	25.0'	26.0'	27.0'	28.0'	29.0'
71 - 80	24.0'	25.0'	26.0'	27.0'	28.0'	29.0'	30.0'	31.0'
81 - 90	25.0'	26.0'	27.0'	28.0'	29.0'	30.0'	31.0'	32.0'
91 - 100	27.0'	28.0'	29.0'	30.0'	31.0'	32.0'	33.0'	34.0'

\* 7' Freefall Distance scenario is only allowed when the FallTech 4-Person Temporary HLL is attached to the FallTech SteelGrip® Stanchion. Freefall should be limited to 6' or less when used with any other anchorage connector.

2.7.3 Minimum Required Fall Clearance for Three or Four Workers w/EAL

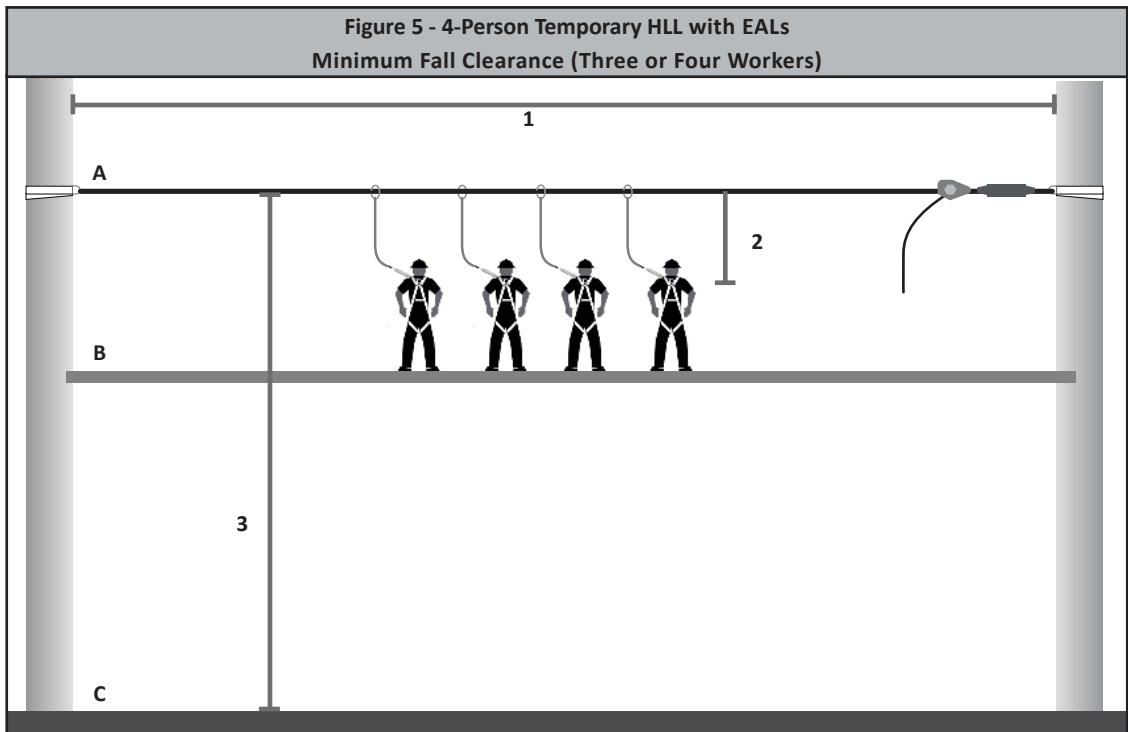

Temporary HLL with EAL Minimum Required Fall Clearance	
310 lbs. Maximum User Capacity Each	Max. Four Workers
1	Find Span Length in Table Below
2	Find Freefall Distance in Table Below
3	Required Fall Clearance at the intersection of Span Length and Freefall Distance (see table below)
A. Overhead Anchorage    B. Walking/Working Surface    C. Nearest Lower Level or Obstruction	
* Work below HLL to avoid Swing Fall	

		Freefall Distance (feet)							
		0	1	2	3	4	5	6	7 *
Span Length (feet)	0 - 30	19.5'	20.5'	21.5'	22.5'	23.5'	24.5'	25.5'	26.5'
	31 - 40	20.5'	21.5'	22.5'	23.5'	24.5'	25.5'	26.5'	27.5'
	41 - 50	22.0'	23.0'	24.0'	25.0'	26.0'	27.0'	28.0'	29.0'
	51 - 60	23.5'	24.5'	25.5'	26.5'	27.5'	28.5'	29.5'	30.5'
	61 - 70	25.5'	26.5'	27.5'	28.5'	29.5'	30.5'	31.5'	32.5'
	71 - 80	28.0'	29.0'	30.0'	31.0'	32.0'	33.0'	34.0'	35.0'
	81 - 90	31.0'	32.0'	33.0'	34.0'	35.0'	36.0'	37.0'	38.0'
	91 - 100	34.0'	35.0'	36.0'	37.0'	38.0'	39.0'	40.0'	41.0'

\* 7' Freefall Distance scenario is only allowed when the FallTech 4-Person Temporary HLL is attached to the FallTech SteelGrip® Stanchion. Freefall should be limited to 6' or less when used with any other anchorage connector.

**⚠ WARNING**

When a worker falls while connected to the horizontal lifeline, the system will deflect. If two or more workers are connected to the same horizontal lifeline, and one worker falls, the other workers may be pulled off the walking-working surface. The potential for the other workers falling increases as the lifeline length increases. The use of independent HLL systems for each person or shorter span lengths is recommended to minimize the potential of the other workers falling.

## 2.7.4 Minimum Required Fall Clearance for up to Four Workers w/SRDs

When attaching up to four Self-Retracting Devices (SRD) to the FallTech 4-Person Temporary HLL system mounted overhead as shown in Figure 5, it is permissible to calculate the required clearance below the working surface by including the typical SRD deceleration distances detailed in the SRD user's instruction manual. Calculating total clearance requirements using typical performance attributes for the SRD will generally result in reduced clearance requirements. Calculating clearance when using SRD's will require the user identify the distance between the walking-working surface and the next level or nearest obstruction. Clearance shall be calculated by adding the total deflection of the HLL during a fall event to the total deceleration distance of the SRD being used, see Figure 6. This combination of lifeline deflection and deceleration distance, when added to the stretch of the user's full body harness, and a safety factor, shall be the minimum required clearance. Failure to calculate clearance requirements could result in serious injury or death during a fall event.

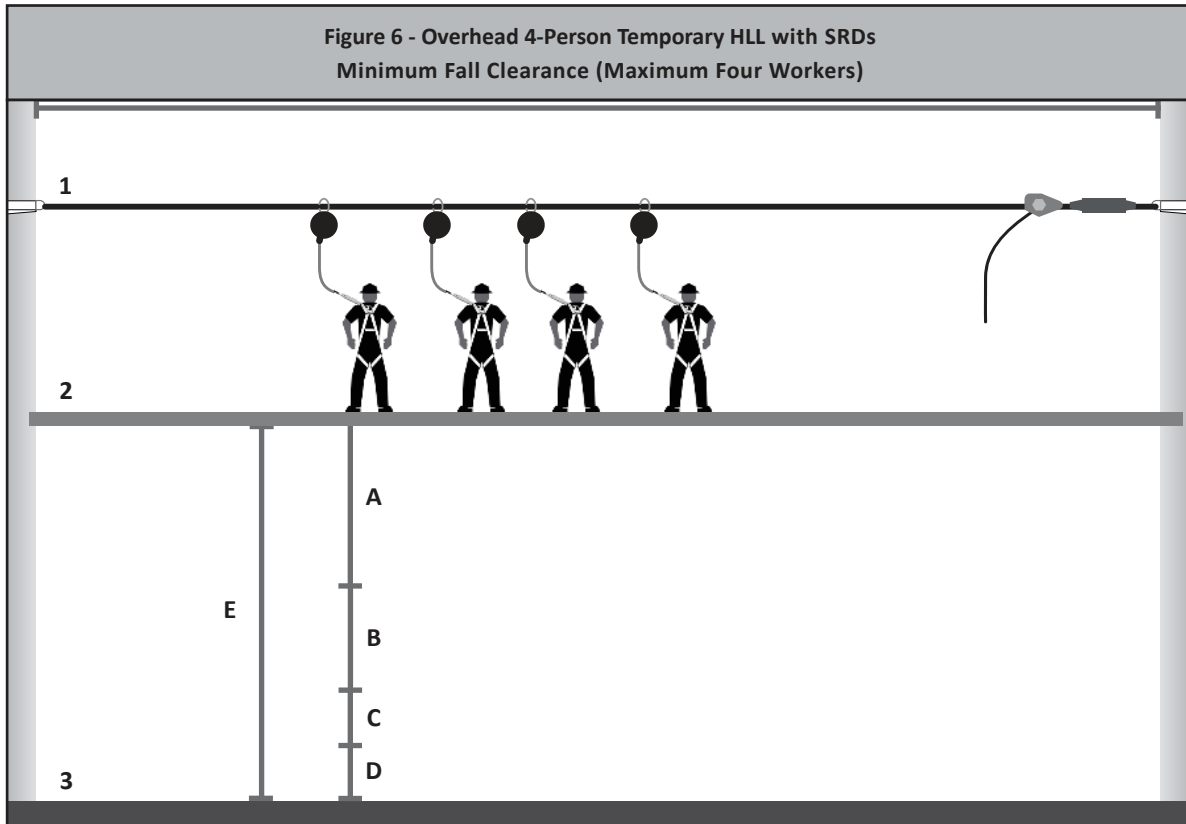

Temporary HLL with SRD Minimum Required Fall Clearance Below Walking/Working Surface		
310 lbs. Maximum User Capacity Each		Max. Four Workers
A		Final Vertical HLL Sag (see chart on the following page)
B		Total SRD Deceleration Distance from User Instruction Manual*
C	1 ft	D-ring Shift and Harness Stretch
D	3 ft	Safety Factor
E		<b>Sub Total - Minimum Required Fall Clearance Below Walking/Working Surface</b> for direct overhead use of SRD (sum of A, B, C and D only)
F	1 ft	<b>* Additional Fall Clearance Calculation</b> due to the use of stanchions
G		<b>Total Minimum Required Fall Clearance When Using Stanchions - (Sum of E and F)</b>
1. Overhead Anchorage    2. Walking/Working Surface    3. Nearest Lower Level or Obstruction		
* If SRD Deceleration Distance is unknown, use 2 feet for ANSI Z359.14-2014 Class A SRDs, 4-1/2 feet for ANSI Z359.14-2014 Class B SRDs, or 3-1/2 feet for ANSI Z359.14-2021 Class 1 or 2 SRDs.		
** Work directly below the HLL to avoid Swing Fall		

Final Vertical HLL Sag for Fall Clearance Calculation When Using SRD(s)			
	One Worker	Two Workers	Three or Four Workers
0 - 30	3.5'	7.0'	11.0'
31 - 40	4.5'	8.5'	12.0'
41 - 50	5.5'	10.0'	13.5'
51 - 60	7.0'	12.0'	15.0'
61 - 70	8.0'	13.5'	17.0'
71 - 80	9.5'	15.0'	20.0'
81 - 90	11.0'	17.0'	22.5'
91 - 100	12.0'	18.5'	25.5'

For worst case clearance calculations the user of the FallTech 4-Person HLL systems may opt to use the ANSI Z359.14 maximum deceleration distances when determining clearance requirements. ANSI Z359.14-2014 allows up to 24" of deceleration for Class A SRDs and up to 54" of deceleration for Class B SRDs. ANSI Z359.14-2021 allows up to 42" of deceleration for Class 1 and 2 SRDs. The charts below demonstrate clearance requirements below the working surface when using the FallTech 4-Man Temporary HLL and attaching either Class A/B or Class 1/2 SRDs to the HLL. Overhead anchorage only.

Required Clearance When Connected to HLL Using ANSI Z359.14-2014 Class A SRDs Below Walking/Working Surface				
Span Length (feet)		One Worker	Two Workers	Four Workers
	0 - 30	9.5'	14.0'	17.0'
	31 - 40	10.5'	14.5'	18.0'
	41 - 50	11.5'	16.0'	19.5'
	51 - 60	13.0'	18.0'	21.0'
	61 - 70	14.0'	19.5'	23.0'
	71 - 80	15.5'	21.0'	24.0'
	81 - 90	17.0'	23.0'	28.5'
	91 - 100	18.0'	24.5'	31.5'

Required Clearance When Connected to HLL Using ANSI Z359.14-2014 Class B SRDs Below Walking/Working Surface				
Span Length (feet)		One Worker	Two Workers	Four Workers
	0 - 30	12.0'	14.0'	19.5'
	31 - 40	13.0'	14.5'	20.5'
	41 - 50	14.0'	19.5'	22.0'
	51 - 60	15.5'	20.5'	23.5'
	61 - 70	16.5'	22.0'	25.5'
	71 - 80	18.0'	23.5'	28.5'
	81 - 90	19.5'	25.5'	31.0'
	91 - 100	20.5'	27.0'	34.0'

Required Clearance When Connected to HLL Using ANSI Z359.14-2021 Class 1/2 SRDs Below Walking/Working Surface				
Span Length (feet)		One Worker	Two Workers	Four Workers
	0 - 30	11.0'	13.0'	18.5'
	31 - 40	12.0'	13.5'	19.5'
	41 - 50	13.0'	18.5'	21.0'
	51 - 60	14.5'	19.5'	22.5'
	61 - 70	15.5'	21.0'	24.5'
	71 - 80	17.0'	22.5'	27.5'
	81 - 90	18.5'	24.5'	30.0'
	91 - 100	19.5'	26.0'	33.0'

**2.8 Rescue:** The FallTech 4-Person Temporary HLL is part of a complete PFAS. It is not intended as a rescue device. Use of this system presents a wide variety of potential rescue scenarios. Users of this system should understand their work environment and develop a rescue plan accordingly. It is recommended that a trained on-site rescue team be present during use of the system.

### 3.0 System Requirements

- 3.1 Anchorage Strength:** End anchors selected for use with this system must have a minimum rating of 5,000 lbs. (22.2 kN) for one- and two-worker applications and 6,000 lbs (26.7 kN) for three- and four-worker applications.
- 3.2 Structure:** The mounting points for the anchorage must be capable of supporting no less than 5,000 lbs. (22.2 kN) for one- and two-worker applications and 6,000 lbs (26.7 kN) for three- and four-worker applications, see Figure 8.

**3.2 Compatibility of Connectors:** Connectors are considered to be compatible with connecting elements when they have been designed to work together in such a way that their sizes and shapes do not cause their gate mechanisms to inadvertently open regardless of how they become oriented. Contact FallTech if you have any questions about compatibility. Connectors must be compatible with the anchorage or other system components. Do not use equipment that is not compatible. Non-compatible connectors may unintentionally disengage. Connectors must be compatible in size, shape, and strength. Self-closing, self-locking snap hooks and carabiners are specified by OSHA and ANSI Z359.12.

**3.3 Compatibility of Components:** Equipment is designed for use with approved components and subsystems only. Substitutions or replacements made with non-ANSI Z359 compliant components or subsystems may jeopardize compatibility of equipment and may affect the safety and reliability of the complete system. Ensure compatibility between the connectors if non-FallTech components are used for fall protection, see Figure 7.

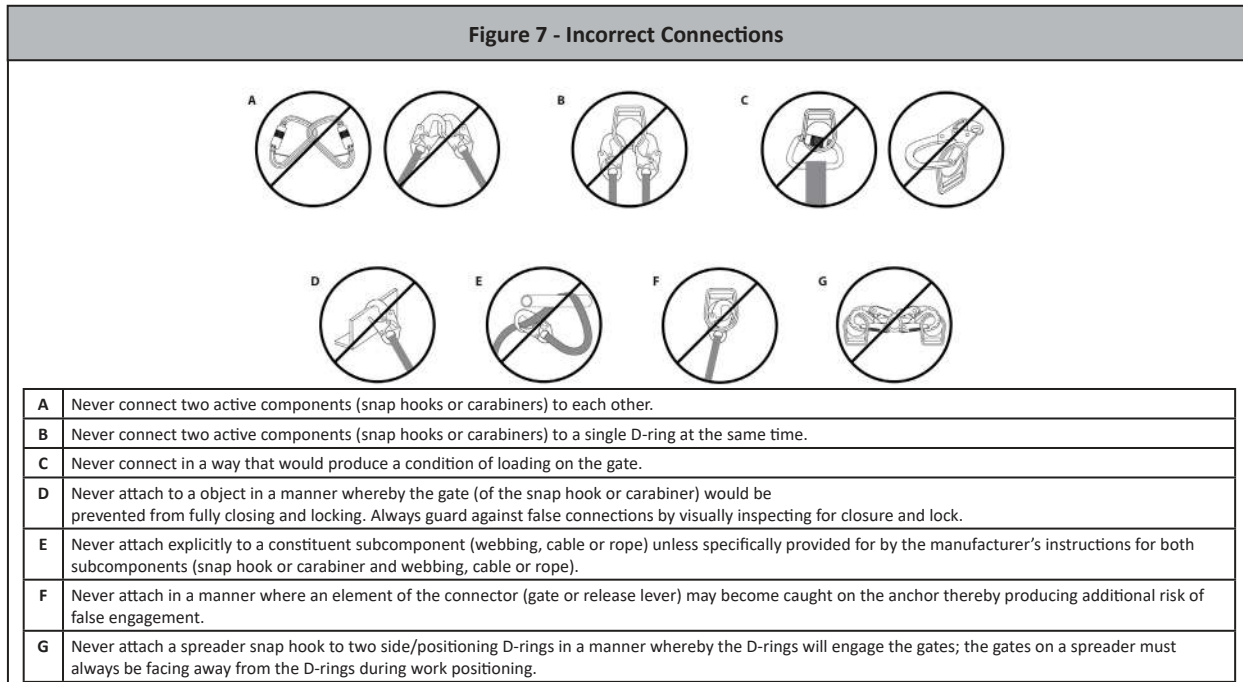

**3.4 Connectors:** Only use self-locking snap hooks, rebar hooks, and carabiners with this equipment. Only use connectors that are suitable to each application. Ensure all connections are compatible in size, shape and strength. Do not use equipment that is not compatible. Visually ensure all connectors close and lock completely. Connectors (snap hooks, rebar hooks, and carabiners) are designed for use only as specified in this manual.

## 4.0 Installation and Use

**4.1 Plan the Personal Fall Arrest System (PFAS):** Inspect the HLL subsystem before each use in accordance with the procedures detailed in Section 6. Examine the work area and take action to address hazards. Falls are a serious hazard when working at height. Training and equipment are the tools of fall hazard management. There are several closely related facets of fall hazard management with a PFAS;

- Anchor Point Selection
- Anchorage Connector
- Deceleration Device
  - Maximum Arrest Force
  - Deceleration Distance
  - Minimum Required Fall Clearance (MRFC)
- Body Wear
- Rescue

**4.2 Anchor Point Selection:** Select a suitable anchor point. Consider the area where the work is being performed. In an overhead anchorage condition, the area below the anchorage is the work zone. Lateral movement away from the anchorage is hazardous. As distance from the anchor increases, the work zone expands, and so does the hazard. Work zone expansion is measured in feet and has a direct influence on user safety. Always work as close to the anchor as possible.

If used in applications with leading edge hazards, anchorage locations must be selected so that the deflected HLL shall not come in contact with a leading edge in the event of a fall. For below D-ring anchor point installations for use with this HLL system, contact FallTech at [info@falltech.com](mailto:info@falltech.com).

**4.3 Anchorage Connector:** Anchorage Connectors used as part of a PFAS should be designed for use with specified anchor points and compatible with the PFAS components and connectors to be used in the assembly of a complete PFAS. Care should be taken to ensure proper assembly, installation and maintenance of all Anchorage Connectors to be used when planning a PFAS. Failure to inspect, assemble, install and/or maintain Anchorage Connectors could result in injury or death.

- 4.4 Connectors/Deceleration Devices:** Connectors and Deceleration Devices such as Shock Absorbing Lanyards, Self-Retracting Devices/Lifelines, and Fall Arrestor Connector Subsystems (Vertical Lifeline/Rope Grab Combinations) are designed to connect the user's body wear to the Anchorage Connector and/or Anchor Point of a Personal Fall Arrest System.
- 4.5 Product Assembly and Installation:** System installation requires end anchor points that are a minimum of 6,000 lbs. (26.7 kN) in both vertical and horizontal directions for three and four workers and 5,000 lbs. (22.2 kN) for one and two workers, see Figure 8. The lifeline shall be installed to limit free fall to 6' or less\*. When using SRDs the lifeline must be positioned overhead. The horizontal lifeline should be positioned in a manner to minimize free fall while allowing ease of use. Movement away from the lifeline should be limited to reduce the potential for swing fall. Lifeline end anchors should be installed at approximately the same elevation so that the lifeline itself is not sloped more than 5 degrees.

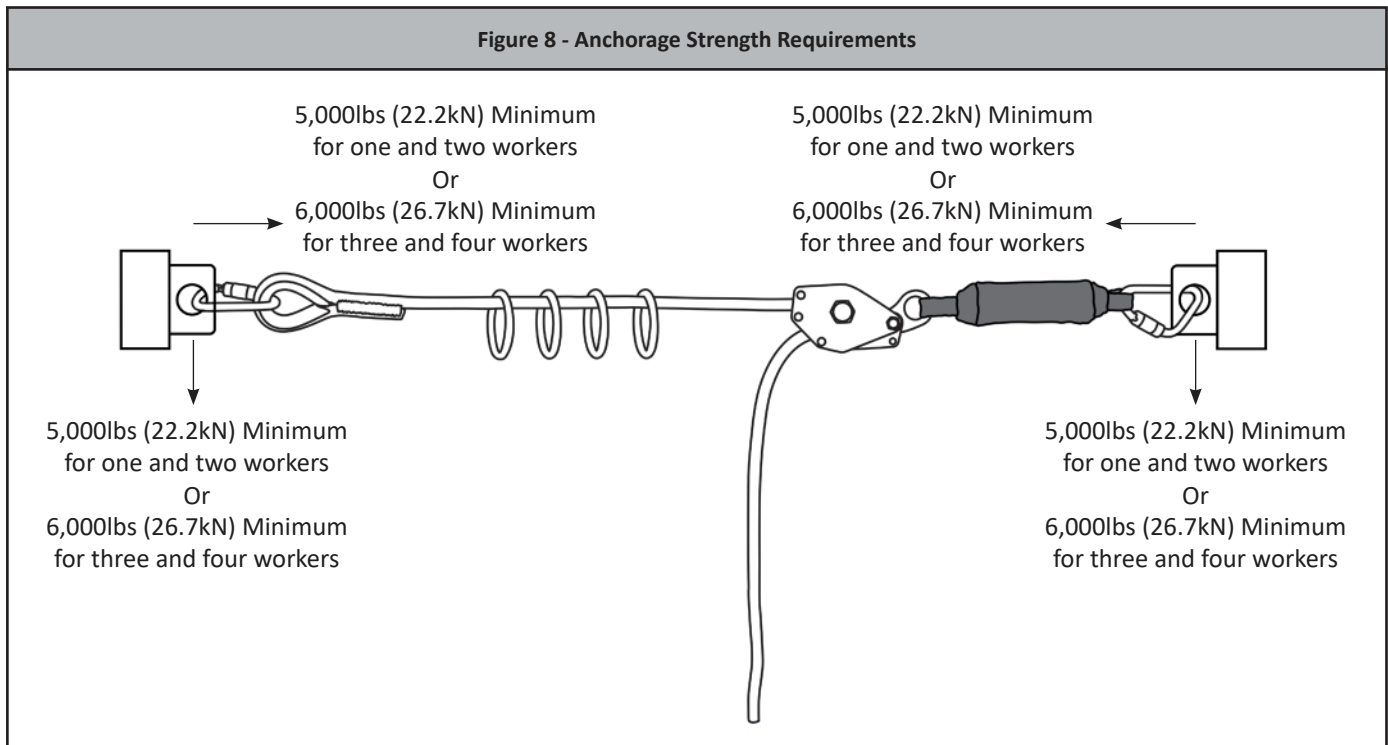

**Step 1:** Determine the location of the end anchorages and, in accordance with Section 3.2, evaluate their strength. Determine the span length of the system and determine the minimum required clearance for safe use in accordance with Section 2.7.

**Step 2:** Install the end anchorage connectors. The FallTech 4-Person Temporary HLL system comes with 2 pass-through anchor straps for wrapping around columns. If using pass through anchor straps, ensure strap is wrapped at least twice around the end anchorage, see Figure 9. This will help prevent sliding of the anchor straps during use. If using alternative anchorage connectors, please ensure the connectors are compliant and conform to the requirements of Section 3.2. Not all anchorage connectors are designed for use with horizontal lifeline systems. In all cases, refer to the user's instruction manual for the end anchorage connectors to be used.

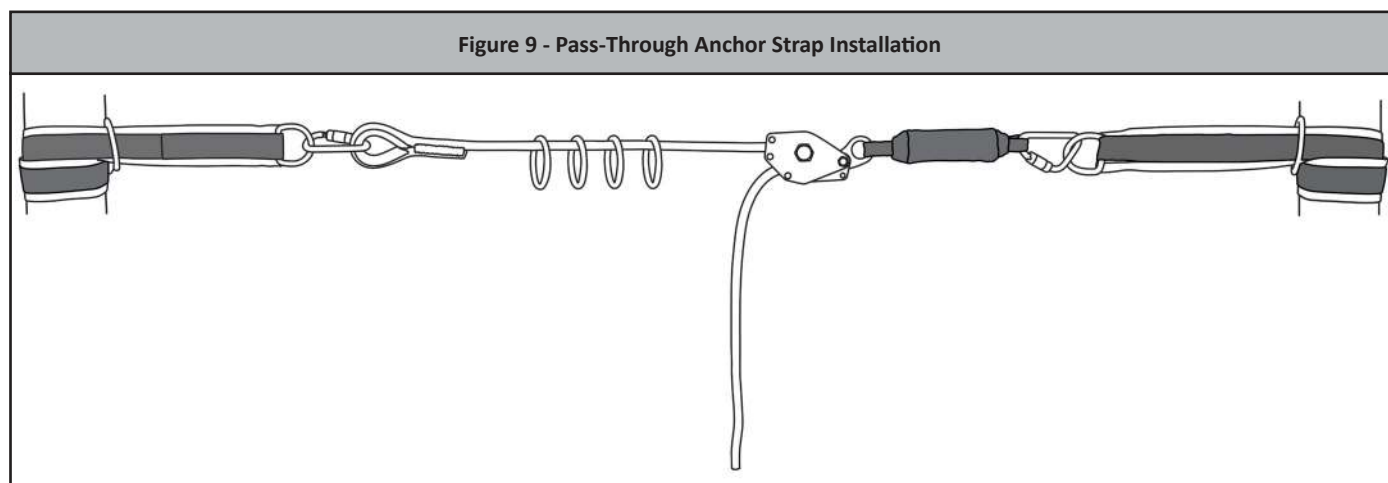

**Step 3:** Secure the HLL system to the anchorage connectors with the provided end attachment carabiners.

**Step 4:** Close the locking lever into the down position so that it is engaged; Figure 10A. Remove the slack from the line by pulling the preinstalled rope through the tensioner by hand, see Figure 10B. Insert a pointed bar through the tensioning nut or use a wrench to tighten by turning the nut clockwise until the tensioner slips or can no longer rotate, see Figure 11. Do not alter the tensioner to achieve greater tension. Final line tension will be approximately 200 - 300 lbf.

**Step 5:** Once properly tensioned, connect a PFAS system only to the connection O-rings that have been preinstalled on the lifeline.

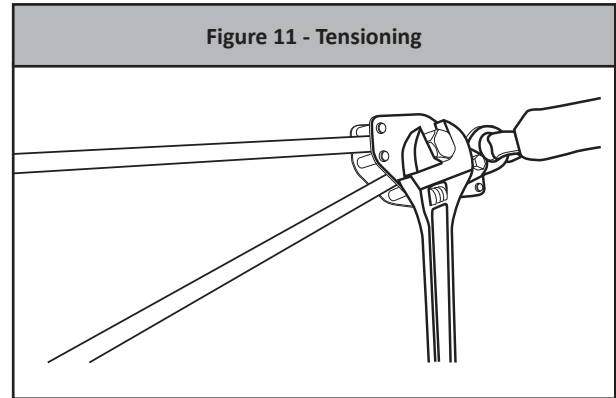
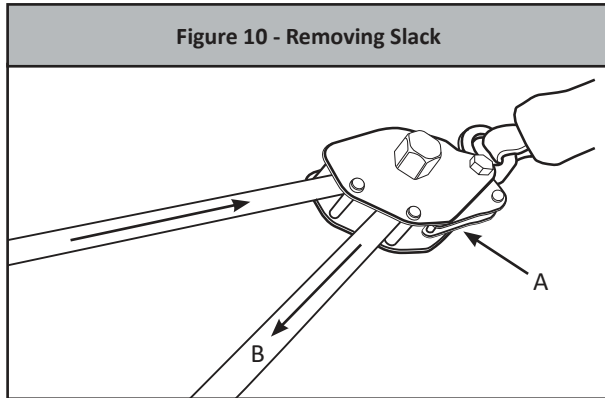

**4.6 Releasing Lifeline Tension:** Upon completion of work, to move to a new work location or to disconnect from the end anchorage connectors lifeline tension should be released. To release lifeline tension:

**Step 1:** Lift the locking lever and position the pointed bar or wrench between the tensioner body and locking lever.

**Step 2:** Pry upward with the pointed bar or wrench to disengage the lock lever and release the HLL tension, see Figure 12A.

**Step 3:** Loosen the tensioning nut with the pointed bar or wrench by turning the tensioning nut counter clockwise until loose, see Figure 12B.

**Step 4:** If necessary, the rope can be pulled through the tensioner by hand while holding the locking lever in the disengaged position, see Figure 12C.

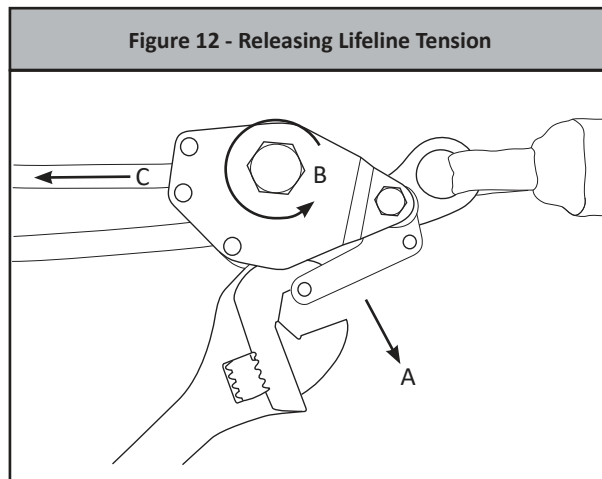

## 5.0 Maintenance, Service and Storage

- Maintenance:** Clean the horizontal lifeline with water and mild detergent. Do not allow excessive build-up of dirt, paint or other agents that may cause damage or hardening of the rope fibers. Do not treat the lifeline with heat to dry or clean the lifeline. Hardening of the ropes fibers from external elements may result in a loss of strength or alter the properties of the rope in a manner that could cause the HLL to fail to operate or perform properly.
- Service:** There are no specific service requirements for this system component.
- Storage:** The system should be stored in its carry bag and kept out of direct sunlight. Store in a clean, dry and chemical free environment.

## 6.0 Inspection

- 6.1 Pre-Use Inspection:** Prior to each use the HLL system should be inspected by the user for damage, wear and to ensure the lifeline is properly tensioned. Please review the inspection checklist for inspection requirements.
- 6.2 Inspection Frequency:** Other than pre-use inspection, the FallTech 4-Person Temporary HLL should be inspected by a competent person at least once a year.
- 6.3 Inspection Checklist:** A general inspection should be done at the intervals specified in this manual. Inspect as follows:
- Step 1:** Inspect labels. Ensure legibility of content. If labels are missing or illegible, remove the system from service.
- Step 2:** Inspect all metal components for cracks, corrosion, deformities, missing parts or noticeable defects. Metal components include O-rings, carabiners, thimble eyes, rope tensioner, D-rings, ferrules etc.
- Step 3:** Inspect rope for wear, paying special attention to the areas of rope most likely in contact with the tensioner teeth. Rope should not present frayed strands, cuts, abrasions, burn marks, and discoloration indicating UV damage.\* Thimble eyes should be firmly in place and there should be no build-up of foreign matter such as paint, dirt, rust, concrete or cement etc.
- \*Minor fuzziness of rope of rope is acceptable so long as the inner white core of the rope is not openly exposed.
- 6.4 Inspection Results:** Inspection results should be recorded by a competent person at least once a year.



## 7.0 Labels

The labels must be present and legible.



**FallTech**  
**DO NOT REMOVE LABEL**  
 Style (estilo)#: 772060  
 Size (tamano): 60'  
 OSHA 1926.502  
 Date of Mig: JAN 2020  
 Capacity (capacidad):  
 4 Workers, 310lbs Each

**60' 4-person Temp Rope HLL  
 System w/Energy Absorber**  
 System Components Material:  
 Rope: Polyester Rope  
 Rope Tensioner: Aluminum  
 Anchor Slings: Polyester  
 Carabiner: Steel  
 Other Hardware: Steel  
 Serial #: 12345679 412-05439 Rev A



All Manufacturer's instructions, labels, and warnings must be read before use and followed at all times for proper use, maintenance, and inspection. Use only with approved fall arrest or fall restraint systems. Users must be fully trained and knowledgeable about all government and regulatory requirements applicable to workplace safety. Ensure horizontal lifeline is located at an elevation which limits free falls to a max of 6 feet or less when using energy absorbing lanyards (EALs). System should be used overhead with self-retracting lifelines (SRLs). For below-D ring anchorage applications, contact Falltech. EALs or SRLs must limit arrest forces to 1,800 lbf or less. System must be installed under the supervision of a competent person. Make only compatible connections. Failure to follow instructions or misuse may result in serious injury or death. Inspect before each use following guidelines found in the user instruction manual. Do not use if unsafe conditions are present. Always log inspection results in user instruction manual and on product labels. 412-03977 Rev B



- 1) USER MUST INSPECT BEFORE EACH USE.
  - 2) COMPETENT PERSON TO INSPECT AT LEAST ONCE EVERY (6) MONTHS.
- MARK OR PUNCH ON DATE GRID:  
 A) INITIAL IN-SERVICE DATE  
 B) DATE OF PASSED INSPECTION  
 IF UNIT FAILS INSPECTION, REMOVE FROM SERVICE

Date:									
Initials:									

412-00079 Rev A

Appendix A

Specifications for the FallTech 4-Person Temporary HLL				
Model #	Minimum Tensile Strength and Material	Maximum User Capacity	Standards and Regulations	Kit Contents
772030 772060 722100	<p><b>6,000 lbs. Minimum Tensile Strength</b></p> <p><b>Rope:</b> 5/8" Diameter Double Braid Polyester 9,000 lbs. Min</p> <p><b>Energy Absorber:</b> Polyester Webbing</p> <p><b>Tensioner:</b> Forged Aluminum Stainless Steel Alloy Steel</p> <p><b>Carabiner:</b> Zinc Plated Forged Alloy Steel</p>	<p>Maximum Four Workers at up to 310 lbs. Each, including clothes, tools, etc.</p>	<p>OSHA 1926.502</p>	

Part Number	Description
7372	Pass-Through Sling Anchors (all lengths)
7393B	Rotating Bolt-on D-Ring Anchor 10k for Steel
7393BS	Rotating Bolt-on D-Ring Anchor 10k for Steel w/ Gr 8 Bolt & Nut
7393BW	Rotating Weld-on D-Ring Anchor 10k w/Puck + Gr 8 Bolt
7446	Removable Concrete Anchor; 6k
7535	12" Stationary Beam Clamp Anchor
7536	24" Stationary Beam Clamp Anchor

Note: The above listing shows the most common FallTech anchors that are compatible with the FallTech 4-Person Temporary Cable Horizontal Lifeline. Contact FallTech for additional information regarding other anchors not on this list.