

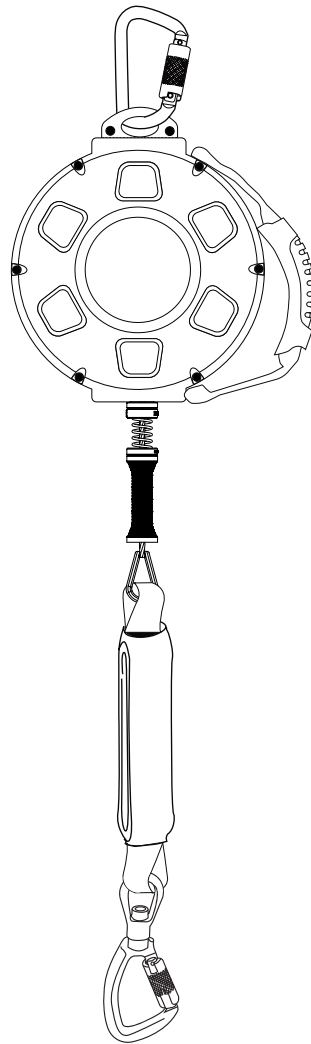

Leading Edge Contractor SRL

User Instruction Manual



This manual is intended to meet the Manufacturer's Instructions as required by the American National Standards Institute (ANSI) Z359 and should be used as part of an employee training program as required by the Occupational Safety and Health Administration (OSHA).

Table of Contents

1.0	Warnings and Important Information	3
2.0	Description	4
3.0	Application	6
4.0	System Requirements	6
5.0	Installation and Use	8
6.0	Maintenance, Service and Storage	13
7.0	Inspection	14
8.0	Labels	16
9.0	Definitions	17
	Appendix A	19

For purposes of this manual, the Leading Edge Contractor SRL in all iterations may be referred to collectively as the LE Contractor, the SRL-LE , the SRD Leading Edge (SRD-LE), the self-retracting device (SRD), the equipment, the device, the product, or the unit.

Throughout this manual, ANSI Z359.0-2012 fall protection words, phrases and terms are used. These terms are all formally defined in Section 9 of this manual.

1.0 Warnings and Important Information

WARNING

- Avoid moving machinery, thermal, electrical and/or chemical hazards as contact may cause serious injury or death.
- Avoid swing falls.
- Follow the weight restrictions and recommendations in this manual.
- Remove from service any equipment subjected to fall arrest forces.
- Remove from service any equipment that fails inspection.
- Do not alter or intentionally misuse this equipment.
- Consult FallTech when using this equipment in combination with components or subsystems other than those described in this manual.
- Do not connect rebar hooks, large carabiners, or large snap hooks to the FBH dorsal D-rings as this may cause a roll-out condition and/or unintentional disengagement.
- Avoid sharp and/or abrasive surfaces and edges.
- Use caution when performing arc welding. Arc flash from arc welding operations, including accidental arcs from electrical equipment, can damage equipment and are potentially fatal.
- Examine the work area. Be aware of the surroundings and workplace hazards that may impact safety, security, and the functioning of fall arrest systems and components.
- Hazards may include but not be limited to cable or debris tripping hazards, equipment failures, personnel mistakes, moving equipment such as carts, barrows, fork lifts, cranes, or dollies. Do not allow materials, tools or equipment in transit to contact any part of the fall arrest system.
- Do not work under suspended loads.

IMPORTANT

This product is part of a personal fall arrest, restraint, work positioning, suspension, or rescue system. A Personal Fall Arrest System (PFAS) is typically composed of an anchorage and a Full Body Harness (FBH), with a connecting device, i.e., a Energy Absorbing Lanyard (EAL), or a Self-Retracting Device (SRD), attached to the dorsal D-ring of the FBH.

These instructions must be provided to the worker using this equipment. The worker must read and understand the manufacturer's instructions for each component or part of the complete system. Manufacturer's instructions must be followed for proper use, care, and maintenance of this product. These instructions must be retained and be kept available for the worker's reference at all times. Alterations or misuse of this product, or failure to follow instructions, may result in serious injury or death.

A Fall Protection Plan must be on file and available for review by all workers. It is the responsibility of the worker and the purchaser of this equipment to assure that users of this equipment are properly trained in its use, maintenance, and storage. Training must be repeated at regular intervals. Training must not subject the trainee to fall hazards.

Consult a doctor if there is reason to doubt your fitness to safely absorb the shock of a fall event. Age and fitness seriously affect a worker's ability to withstand falls. Pregnant women or minors must not use this equipment.

ANSI limits the weight of fall protection equipment users to a maximum of 310 lbs. Products in this manual may have a rated capacity exceeding ANSI capacity limits. Heavy users experience more risk of serious injury or death due to falls because of increased fall arrest forces placed on the user's body. In addition, the onset of suspension trauma after a fall even may be accelerated for heavy users.

The user of the equipment discussed in this manual must read and understand the entire manual before beginning work.

NOTE: For more information consult the ANSI Z359 body of standards.

2.0 Description

The FallTech® Leading Edge Contractor is a self-retracting device for those working at height and when may be subject to Leading Edge fall hazards, see Figure 10 for typical extreme sharp edges.

This manual contains one Appendix that contains figures and tables specific to the LE Contractor SRL Leading Edge discussed in this manual.

The SRD discussed in this manual may be attached to an overhead anchorage, i.e., from directly over the user’s head, to as low as the level of the user’s FBH dorsal D-ring. The SRD may also be attached to a non-overhead anchorage, i.e., level with the user’s FBH dorsal D-ring, down to foot level, to a maximum of 5’ below the user’s FBH dorsal D-ring.

Leading edge means the unprotected side and edge of a floor, roof, or form work for a floor or other walking/working surface (such as deck) which changes location as additional floor, roof, decking or form work sections are placed, formed or constructed. The shape and texture of a leading edge may vary, see Figure 11.

As shown in Figure 1 below, the SRD has a glass reinforced nylon housing with an integrated handle that contains a lifeline composed of 7/32” (5.6mm) diameter galvanized steel wire rope, wound onto a spring tensioned drum. The SRD’s lifeline is equipped with a cable stop/handle assembly with a bumper, integrated tearaway Energy Absorber (EA), and a steel swivel snaphook. When the user is attached, the lifeline extends and retracts with user movement, automatically maintaining a taut lifeline. If a fall occurs, a centrifugal pawl system engages, stopping the lifeline payout. The tearaway EA deploys, gradually slowing and arresting the fall.

See Table 1A in Appendix A for product and materials specifications.

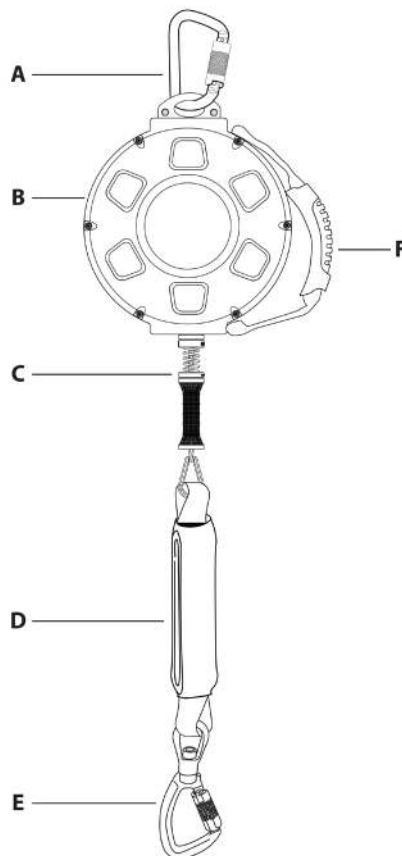

Figure 1: About Leading Edge Contractor SRL

Figure 1: About Leading Edge Contractor SRL	
A	Anchorage Connecting Carabiner
B	SRD Unit Housing
C	Cable-Stop/Handle Assembly (spring/bumpers)
D	Integral Energy Absorber
E	Load-indicating Swivel Snaphook
F	Carry Handle

2.1 American National Standards Institute (ANSI) and Occupational Safety and Health Administration (OSHA): The SRD discussed in this manual meets the standards of ANSI Z359.14-2021, ANSI A10.32-2012, and Occupational Safety and Health Administration (OSHA) regulations 1926.502 and 1910.140. ANSI requires SRDs be classified according to the type of usage the user would be exposed to, and are tested either as Class 1 or Class 2. Dynamic performance means that the SRD is installed in a testing drop tower. A test weight is attached to the SRD and then dropped. Test results are recorded.

Parameters recorded are:

- Arrest Distance (AD)
- Average Arrest Force (AAF)
- Maximum Arrest Force (MAF)

The Arrest Distance is the total vertical distance required to arrest a fall. The Arrest Distance includes the deceleration distance and the activation distance. The Average Arrest Force is the average of the forces applied to the body and the anchorage by the fall protection system. The Maximum Arrest Force is the maximum amount of force that may be applied to the body and the anchorage by the fall protection system. In addition to the above tests conducted in ambient conditions, the units must be retested for average and peak forces under certain environmental conditions, where the units are cooled, then tested, heated, then tested, or saturated in water and tested again. Separate units may be used for each test. All test results are recorded.

This test data is then used to establish the basis for fall clearance guidelines published in the user instruction manual.

Class 1 and 2: Class 1 devices shall be used only on overhead anchorages and shall be subjected to a maximum free fall of 2 feet (0.6 m) or less. Class 2 devices are intended for applications where an overhead anchorage may not be available or feasible and be subjected to a free fall of no more than 6 feet (1.8 m) over an edge.

To be declared a Class 1 and Class 2 device, ANSI requires an SRD to have an overhead Arrest Distance of less than 42" (1.1 m), an Average Arrest Force of less than 1,350 lbs (6 kN) [1,575 lbs (7 kN) conditioned] and a Maximum Arresting Force of 1,800 lbs (8 kN), for both ambient and conditioned testing.

When dynamically tested in accordance with requirements of ANSI Z359.14-2021, FallTech Class 1 and Class 2 Self-Retracting Devices have an AAF of 1,350 lbs (6 kN) or less and an AD of less than 42" (1.1 m).

Please see Section 5 of this user instruction manual for how to calculate your Minimum Required Fall Clearance (MRFC).

Class 2 SRLs shall include labels illustrating a fall clearance table and a diagram of the axes shown on the table. These labels shall be affixed to the product. The Leading Edge Contractor includes these labels in the Energy Absorber.

Please see Section 5.2 of this user instruction manual for how to calculate your Minimum Required Fall Clearance (MRFC) using the affixed labels.

Classification information found on product labels is based on test results. Table 1B provides test performance results for the SRD discussed in this manual. NOTE: Arrest distance is one of several parts of the Minimum Required Fall Clearance (MRFC). MRFC is discussed in detail in Section 5 .

OSHA requires an SRD limit the free fall to 2 feet (0.9 m) or less. If the maximum free fall distance must be exceeded, the employer must document, based on test data, that the maximum arresting force will not be exceeded, and the personal fall arrest system will function properly. The SRD discussed in this manual was successfully tested for horizontal use and falls over a steel edge without burrs, as found on steel shapes and metal sheeting, and may be used in situations where a fall may occur over similar edges, such as found on steel shapes or metal sheeting.

3.0 Application

3.1 Purpose: The FallTech Leading Edge Contractor SRL is designed to be used as a component in a Personal Fall Arrest System (PFAS), to provide a combination of worker mobility and fall protection as required for inspection work, general construction, maintenance work, oil production, confined space work, etc. The SRL-LE is intended for fall protection in Leading Edge applications where falls may occur over edges.

3.2 Personal Fall Arrest System: A PFAS is an assembly of components and subsystems used to arrest a person during a fall event. A PFAS typically consists of an anchorage, a deceleration device such as a Energy Absorbing Lanyard (EAL), a Self-Retracting Device (SRD), or a Fall Arrestor Connecting Subsystem (FACSS), and a properly fitted Full Body Harness (FBH). Maximum permissible free fall in a typical PFAS is 6' (1.8 m). The SRD discussed in this manual may be used in non-overhead anchorage situations. Clearance calculators provided in this manual offer methods for calculating MRFC for non-overhead anchorage locations when the SRD is set back from 0' to 4' (1.2 m) and non-overhead anchorage locations that are set back 5' (1.5m) or greater, see Figure 2.

1	Anchorage of SRD at Foot Level with 0' Setback from Leading Edge
2	Anchorage of SRD at Foot Level with 5' Setback from Leading Edge
3	Overhead Anchorage of SRD Above Dorsal D-Ring
4	Anchorage of SRD Above Dorsal D-Ring with 5' Setback from Leading Edge

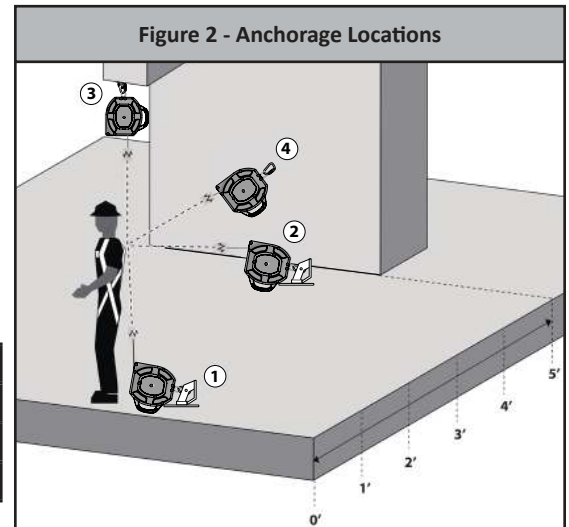

3.3 Horizontal Lifeline (HLL) and Rail Systems: The SRD may be attached to rigid and flexible anchors provided that all HLL or rail system applications, installation, and uses are under the supervision of a Qualified Person.

3.4 Rescue: Ensure a written rescue plan, method and system is in place and readily available for rapid response. Rescues may require specialized equipment or measures. Rescue operations are beyond the scope of this manual. See ANSI Z359.4 and Z359.2.

3.5 Application Limits: The SRD discussed in this manual is designed for Leading Edge applications. However, take caution to avoid very sharp edges such as sheared metals, metals cut with an abrasive disk, or flame-cut metals. Also take caution around very abrasive surfaces and edges, such as concrete or stone, as these edges and surfaces may abrade the lifeline or the energy absorber during a fall event.

4.0 System Requirements

4.1 Capacity: The SRD is designed for use by a single user with a combined weight of user, tools, clothing, etc., of 130–310 lbs (59-141 kg).

4.2 Compatibility of Connectors: Connectors are considered to be compatible with connecting elements when they have been designed to work together in such a way that their sizes and shapes do not cause their gate mechanisms to inadvertently open regardless of how they become oriented. Contact FallTech if you have any questions about compatibility. Connectors must be compatible with the anchorage or other system components. Do not use equipment that is not compatible. Non-compatible connectors may unintentionally disengage. Connectors must be compatible in size, shape, and strength. Self-closing, self-locking connectors are required by ANSI and OSHA.

4.3 Compatibility of Components: Equipment is designed for use with approved components and subsystems only. Substitutions or replacements made with non-approved components or subsystems may jeopardize compatibility of equipment and may affect the safety and reliability of the complete system.

4.4 Making Connections: Only use self-locking connectors with this equipment. Only use connectors that are suitable to each application. Ensure all connections are compatible in size, shape, and strength. Do not use equipment that is not compatible, see Figure 3. Visually ensure all connectors are fully closed and locked. Connectors are designed to be used only as specified in each product's user's instructions.

Figure 3 - Non-Compatible Connections

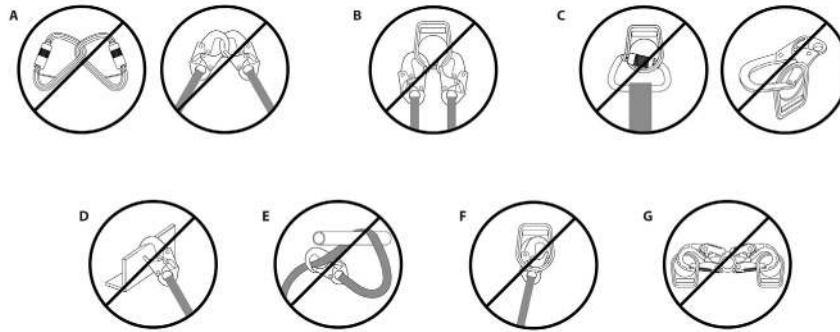

A	Never connect two active components (snap hooks or carabiners) to each other.
B	Never connect two active components (snap hooks or carabiners) to a single D-ring at the same time.
C	Never connect in a way that would produce a condition of loading on the gate.
D	Never attach to a object in a manner whereby the gate (of the snap hook or carabiner) would be prevented from fully closing and locking. Always guard against false connections by visually inspecting for closure and lock.
E	Never attach explicitly to a constituent subcomponent (webbing, cable or rope) unless specifically provided for by the manufacturer's instructions for both subcomponents (snap hook or carabiner and webbing, cable or rope).
F	Never attach in a manner where an element of the connector (gate or release lever) may become caught on the anchor thereby producing additional risk of false engagement.
G	Never attach a spreader snap hook to two side/positioning D-rings in a manner whereby the D-rings will engage the gates; the gates on a spreader must always be facing away from the D-rings during work positioning.

4.5 Personal Fall Arrest System: A PFAS is an assembly of components and subsystems used to arrest a person during a fall event. A PFAS is typically composed of an anchorage and a FBH, with an energy absorbing connecting device, i.e., an SAL, an SRD, or a Fall Arrestor Connecting Subsystem (FACSS), connected to the dorsal D-ring of the FBH. PFAS components used in conjunction with this SRD should comply with ANSI Z359 and applicable OSHA regulations.

4.6 Average Arrest Force and Arrest Distance: Table 1B provides test data on typical performance attributes of the three principal parameters, Arrest Distance, Average Arrest Force and Maximum Arrest Force, listed by model number and class. Testing is conducted under various environmental conditions; at ambient temperature, plus hot, cold, and in wet conditions. In manufacturer's tests, worst case performance attributes of the SRD, connected at foot-level (maximum of 5 feet below the dorsal D-ring) in a Leading Edge application with 5' (1.5m) of setback, or with 0' setback, are:

	5' (1.5 m) Setback	0' Setback
Longest Arrest Distance	130" (3.3 m)	137" (3.5 m)
Largest Average Arrest Force	1,255 lbs (5.6 kN)	975 lbs (4.3 kN)
Largest Maximum Arrest Force	1,791 lbs (8.0 kN)	1,627 lbs (7.2 kN)

The Competent Person may find this data useful with planning anchorage location and calculating fall arrest loads and distances from the walking/working level to the nearest obstruction or lower level. See Section 5.

NOTE: Arrest distance is one part of the Minimum Required Fall Clearance (MRFC). The MRFC is determined by consideration of multiple factors in fall protection. Attachment below the level of the FBH D-ring will require additional fall clearance. MRFC is discussed in detail in Section 5.

4.7 PFAS Anchorage Strength: An anchorage selected for PFAS must have a strength able to sustain a static load applied in the direction permitted by the PFAS of at least:

- a) Two times the maximum arrest force permitted when certification exists, or
- b) 5,000 lbs. (22.2 kN) in the absence of certification.

Select an anchorage location carefully. Consider structural strength, obstructions in the fall path, and swing fall hazards. In certain situations, the qualified person can determine that a given structure is able to withstand the applied MAF of the PFAS with a safety factor of at least two, as required by OSHA.

5.0 Installation and Use

WARNING

Do not alter or intentionally misuse this equipment. Consult FallTech when using this equipment in combination with components or subsystems other than those described in this manual. All components or subsystems used with the SRD discussed in this manual must be in compliance with ANSI Z359 and/or OSHA.

Do not use rebar hooks, large carabiners or large snap hooks to connect to the FBH dorsal D-rings or to any small diameter non-compatible anchor point as this may cause a roll-out condition and/or unintentional disengagement.

Do not insert extra connectors between the SRD lifeline connector and the FBH dorsal D-ring, except an approved D-ring extender.

Use caution. Take action to avoid sharp and/or abrasive surfaces and edges when possible.

- 5.1 Install the SRD:** Examine the work area for possible hazards. Take caution to avoid overhead hazards such as cranes, poles, overhead power cables, and walking/working surface hazards such as power cables, welding leads, air and fluid hoses, including obstruction hazards such as vertical columns and stacks of materials on the lower level. Eliminate hazards where possible.

Ensure the anchorage provides the Minimum Required Fall Clearance (MRFC) in the fall path below the walking/working surface to prevent striking the lower level or an obstruction during a fall event. Take action to avoid swing falls, which occur when the anchorage is not directly above the point where the fall occurs.

Fall clearance and swing falls are subject to variable conditions. Anchor height, lateral movement, and setback distance all affect anchor location with regard to fall clearance and swing fall.

The SRD may be attached to an overhead anchor, i.e. above the user's FBH dorsal D-ring, or a non-overhead anchor, i.e., below the user's FBH dorsal D-ring. A non-overhead anchor may be as low as foot level, but no more than a maximum of 5' (1.5m) below the user's FBH dorsal D-ring. Non-overhead anchor locations result in greater contact between the lifeline and the edge and present greater abrasion risk hazards.

Use of a foot level anchorage should be as a last resort, when no other anchor option exists.

Performance testing has shown that a fall event over a leading edge will alter SRD performance characteristics and fall clearance requirements. When anchored below the FBH back D-ring fall events will result in greater fall clearances. Reduced setback distances will also increase clearance requirements. Non-overhead anchorage when the SRD is set back less than 5' (1.5 m) will result in the greatest MRFC and the least amount of worker mobility due to swing fall. Greater set back distances of 5' (1.5 m) or more will reduce the overall MRFC and allow for more lateral movement of the worker when attached to a non-overhead anchorage.

If job site geometry allows it, a setback distance of 5' (1.5 m) is recommended to take full advantage of the SRD performance. In addition, the Angle of Redirection of the lifeline, i.e., the angle of the lifeline as it passes over the edge, must be at 90 degrees or more, never less, see Section 5.3.

Do not attach the SRD in a manner that places the edge higher than the SRD.

5.2 Calculating Minimum Required Fall Clearance

5.2.1 LE Contractor in Overhead, Non-Leading Edge Anchorage Application

The LE Contractor may be used as a standard SRD in an overhead condition, in which the SRD is installed anywhere in the allowable attachment area, which ranges from directly above the user to level with the FBH D-ring, as shown in Figure 4.

The overhead condition minimum required fall clearance (MRFC) is calculated using four metrics, measured from the walking-working surface: SRD Deceleration Distance, D-Ring Shift and Harness Stretch [1 ft (0.3m)], Safety Factor [1.5 ft (0.5m)], and Swing Fall. Chart 1 below is calculated using the performance data of the SRD and includes all four metrics listed previously to determine the MRFC.

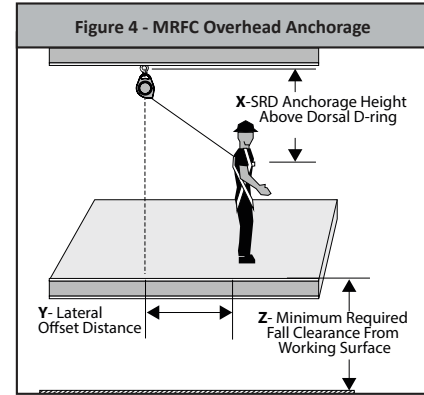

Chart 1 Overhead		Lateral Offset Distance (Y)												
		0 ft (0 m)	2 ft (0.7 m)	4 ft (1.3 m)	6 ft (1.9 m)	8 ft (2.5 m)	10 ft (3.1 m)	12 ft (3.7 m)	14 ft (4.3 m)	16 ft (4.9 m)	18 ft (5.5 m)	20 ft (6.1 m)	22 ft (6.8 m)	24 ft (7.4 m)
SRD Anchorage Height Above Dorsal D-Ring (X)	50 ft (15.3 m)	6.0 (1.9)	6.5 (1.9)	6.5 (1.9)	6.5 (2.0)	7.0 (2.1)	7.0 (2.2)	7.5 (2.3)	8.0 (2.5)	8.5 (2.6)	9.5 (2.8)	10.0 (3.1)	11.0 (3.3)	11.5 (3.5)
	45 ft (13.8 m)	6.0 (1.9)	6.5 (1.9)	6.5 (1.9)	6.5 (2.0)	7.0 (2.1)	7.5 (2.2)	8.0 (2.4)	8.5 (2.5)	9.0 (2.7)	9.5 (2.9)	10.5 (3.2)	11.5 (3.4)	12.0 (3.7)
	40 ft (12.2 m)	6.0 (1.9)	6.5 (1.9)	6.5 (1.9)	6.5 (2.0)	7.0 (2.1)	7.5 (2.3)	8.0 (2.4)	8.5 (2.6)	9.5 (2.8)	10.0 (3.1)	11.0 (3.3)	12.0 (3.6)	13.0 (3.9)
	35 ft (10.7 m)	6.0 (1.9)	6.5 (1.9)	6.5 (1.9)	7.0 (2.0)	7.0 (2.2)	7.5 (2.3)	8.0 (2.5)	9.0 (2.7)	9.5 (2.9)	10.5 (3.2)	11.5 (3.5)	12.5 (3.8)	13.5 (4.1)
	30 ft (9.2 m)	6.0 (1.9)	6.5 (1.9)	6.5 (2.0)	7.0 (2.1)	7.5 (2.2)	8.0 (2.4)	8.5 (2.6)	9.5 (2.8)	10.0 (3.1)	11.0 (3.4)	12.5 (3.7)	13.5 (4.1)	14.5 (4.4)
	25 ft (7.7 m)	6.0 (1.9)	6.5 (1.9)	6.5 (2.0)	7.0 (2.1)	7.5 (2.3)	8.0 (2.5)	9.0 (2.7)	10.0 (3.0)	11.0 (3.3)	12.0 (3.6)	13.5 (4.0)	14.5 (4.4)	16.0 (4.8)
	20 ft (6.1 m)	6.0 (1.9)	6.5 (1.9)	6.5 (2.0)	7.0 (2.1)	8.0 (2.3)	8.5 (2.6)	9.5 (2.9)	10.5 (3.2)	12.0 (3.6)	13.0 (4.0)	14.5 (4.4)	16.0 (4.8)	17.5 (5.3)
	15 ft (4.6 m)	6.0 (1.9)	6.5 (1.9)	7.0 (2.0)	7.5 (2.2)	8.0 (2.5)	9.5 (2.9)	10.5 (3.2)	12.0 (3.6)	13.0 (4.0)	14.5 (4.4)	16.0 (4.9)	18.0 (5.4)	19.5 (5.9)
	10 ft (3.1 m)	6.0 (1.9)	6.5 (1.9)	7.0 (2.1)	8.0 (2.4)	9.0 (2.7)	10.5 (3.1)	12.0 (3.6)	13.5 (4.1)	15.0 (4.6)	17.0 (5.1)	18.5 (5.6)	20.5 (6.2)	22.0 (6.8)
	5 ft (1.6 m)	6.0 (1.9)	6.5 (1.9)	7.5 (2.3)	9.0 (2.7)	10.5 (3.1)	12.5 (3.6)	14.0 (4.1)	16.0 (4.6)	18.0 (5.5)	20.0 (6.0)	22.0 (6.6)	24.0 (7.2)	26.0 (7.8)
	0 ft (0 m)	6.0 (1.9)	8.0 (2.5)	10.0 (3.1)	12.0 (3.7)	14.0 (4.3)	16.0 (4.9)	18.0 (5.5)	20.0 (6.1)	22.0 (6.8)	24.0 (7.4)	26.0 (8.0)	28.0 (8.6)	30.0 (9.2)

Using Chart 1 to Calculate Minimum Required Fall Clearance for the LE Contractor

2 foot (0.6 m) increments along the Y-Axis represent the **Lateral Offset Distance** the user is working away from being directly under the SRD

5 foot (1.5 m) increments up the X-Axis represent the **SRD Anchorage Height** above the user's Dorsal D-Ring

Example:

If the user needs to work 10 feet (3.1 m) away from directly under the SRD, the SRD needs to be anchored at least 15 feet (4.6 m) above the user's Dorsal D-Ring. Minimum required fall clearance is 9.5 feet (2.9 m) at maximum allowable swing fall.

Example:

If the only suitable Anchorage for the SRD is at D-Ring height [0.0 feet (0.0 m)] above the user's Dorsal D-Ring, the maximum allowable work zone is 4 feet (1.3 m) away from the SRD. Minimum required fall clearance is 10.0 feet (3.1m) at maximum allowable swing fall.

Key to Work Zone Areas:



= Allowable Use Area



= Not Allowed Use Area



WORKING IN THIS AREA



MAY RESULT IN SERIOUS INJURY OR DEATH

5.2.2 LE Contractor Non-Overhead Anchorage

The leading edge/below D-ring condition minimum required fall clearance (MRFC) is calculated using five metrics, measured from the walking-working surface: SRD Deceleration Distance, D-Ring Shift and Harness Stretch [1 ft (0.3m)], Safety Factor [1.5 ft (0.5m)], Dorsal D-ring Height [5 ft (1.5m)], and Swing Fall. Dorsal D-ring height is added to account for the below D-ring tie-off compared to the overhead condition. Chart 2 below is calculated using the performance data of the SRD and includes all five metrics listed previously to determine the MRFC.

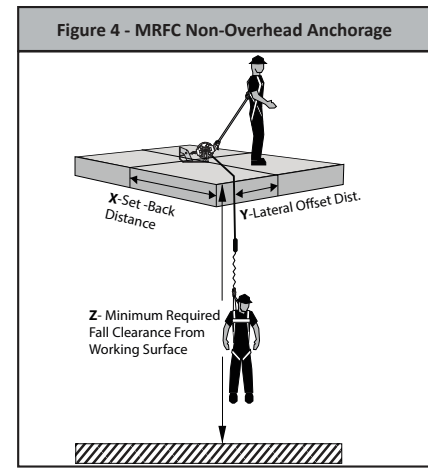

Chart 2 Non-Overhead		Lateral Offset Distance (Y)												
		0 ft (0 m)	2 ft (0.7 m)	4 ft (1.3 m)	6 ft (1.9 m)	8 ft (2.5 m)	10 ft (3.1 m)	12 ft (3.7 m)	14 ft (4.3 m)	16 ft (4.9 m)	18 ft (5.5 m)	20 ft (6.1 m)	22 ft (6.8 m)	24 ft (7.4 m)
SRD Setback Distance from Edge (X)	0 ft (0 m)	19.0 (5.8)	21.0 (6.4)	23.0 (6.9)	25.0 (7.6)	27.0 (8.2)	29.0 (8.8)	31.0 (9.4)	33.0 (10.0)	35.0 (10.7)	37.0 (11.3)	39.0 (11.9)	41.0 (12.5)	43.0 (13.1)
	5 ft (1.6 m)	19.0 (5.8)	19.5 (6.0)	20.5 (6.3)	22.0 (6.8)	23.5 (7.2)	25.5 (7.8)	27.0 (8.2)	29.0 (8.8)	31.0 (9.4)	33.0 (10.0)	35.0 (10.7)	36.5 (11.0)	38.5 (11.7)
	10 ft (3.1 m)	19.0 (5.8)	19.5 (6.0)	20.0 (6.1)	21.0 (6.4)	22.0 (6.8)	23.5 (7.2)	25.0 (7.6)	26.5 (8.1)	28.0 (8.5)	29.5 (9.0)	31.5 (9.6)	33.5 (10.2)	35.0 (10.7)
	15 ft (4.6 m)	19.0 (5.8)	19.5 (6.0)	19.5 (6.0)	20.5 (6.3)	21.0 (6.4)	22.0 (6.8)	23.5 (7.2)	24.5 (7.5)	26.0 (7.9)	27.5 (8.4)	29.0 (8.8)	31.0 (9.4)	32.5 (10.0)
	20 ft (6.1 m)	19.0 (5.8)	19.0 (5.8)	19.5 (6.0)	20.0 (6.1)	20.5 (6.3)	21.5 (6.6)	22.5 (6.8)	23.5 (7.2)	25.0 (7.6)	26.0 (7.9)	27.5 (8.4)	29.0 (8.8)	30.5 (9.3)
	25 ft (7.7 m)	19.0 (5.8)	19.0 (5.8)	19.5 (6.0)	20.0 (6.1)	20.5 (6.3)	21.0 (6.4)	22.0 (6.8)	23.0 (6.9)	24.0 (7.3)	25.0 (7.6)	26.0 (7.9)	27.5 (8.4)	29.0 (8.8)
	30 ft (9.2 m)	19.0 (5.8)	19.0 (5.8)	19.5 (6.0)	19.5 (6.0)	20.0 (6.1)	21.0 (6.4)	21.5 (6.6)	22.5 (6.8)	23.0 (6.9)	24.0 (7.3)	25.0 (7.6)	26.5 (8.1)	27.5 (8.4)
	35 ft (10.7 m)	19.0 (5.8)	19.0 (5.8)	19.5 (6.0)	19.5 (6.0)	20.0 (6.1)	20.5 (6.3)	21.0 (6.4)	22.0 (6.8)	22.5 (6.8)	23.5 (7.2)	24.5 (7.5)	25.5 (7.8)	26.5 (8.1)
	40 ft (12.2 m)	19.0 (5.8)	19.0 (5.8)	19.5 (6.0)	19.5 (6.0)	20.0 (6.1)	20.5 (6.3)	21.0 (6.4)	21.5 (6.6)	22.0 (6.8)	23.0 (6.9)	24.0 (7.3)	25.0 (7.6)	26.0 (7.9)
	45 ft (13.8 m)	19.0 (5.8)	19.0 (5.8)	19.5 (6.0)	19.5 (6.0)	20.0 (6.1)	20.0 (6.1)	20.5 (6.3)	21.5 (6.6)	22.0 (6.8)	22.5 (6.8)	23.5 (7.2)	24.0 (7.3)	25.0 (7.6)
	50 ft (15.3 m)	19.0 (5.8)	19.0 (5.8)	19.5 (6.0)	19.5 (6.0)	20.0 (6.1)	20.0 (6.1)	20.5 (6.3)	21.0 (6.4)	21.5 (6.6)	22.5 (6.8)	23.0 (6.9)	24.0 (7.3)	24.5 (7.5)

Using Chart 2 to Calculate Minimum Required Fall Clearance for the LE Contractor

2 foot (0.6 m) increments along the Y-Axis represent the Lateral Offset Distance the user is working away from being directly under the SRD	5 foot (1.5 m) increments up the X-Axis represent the SRD Setback Distance from Edge
Example: If the user needs to work 10 feet (3.1 m) away from the SRD along the edge, the SRD needs to be anchored back at least 15 feet (4.6 m) from the edge. Minimum required fall clearance is 19.5 feet (6.0 m) at maximum allowable swing fall.	
Example: If the only suitable Anchorage for the SRD is at the edge [0.0 feet (0.0 m)], the maximum allowable work zone is 4 feet (1.3 m) away from the SRD. Minimum required fall clearance is 20.5 feet (6.3 m) at maximum allowable swing fall.	
Key to Work Zone Areas: <div style="display: flex; justify-content: space-around; align-items: center;"> <div style="border: 1px solid black; width: 30px; height: 30px; display: flex; align-items: center; justify-content: center;"> </div> = Allowable Use Area <div style="background-color: red; width: 30px; height: 30px; display: flex; align-items: center; justify-content: center;"> </div> = Not Allowed Use Area </div>	
WORKING IN THIS AREA MAY RESULT IN SERIOUS INJURY OR DEATH	

⚠ WARNING

An expanded work zone combined with an SRD attached at or near foot level will have a high risk of serious injury or death.

5.3 Angle of Redirection: The angle of redirection is the angle of the lifeline over an edge during a fall event. Install the SRD so that the angle of the two parts of the lifeline are at least 90°, or more, but never less, as shown in Figure 10. The lifeline must never rise up to the edge as it may bend the lifeline in too small a radius and/or severely abrade, or otherwise compromise, the lifeline.

Do not work with the leading edge above the anchorage.

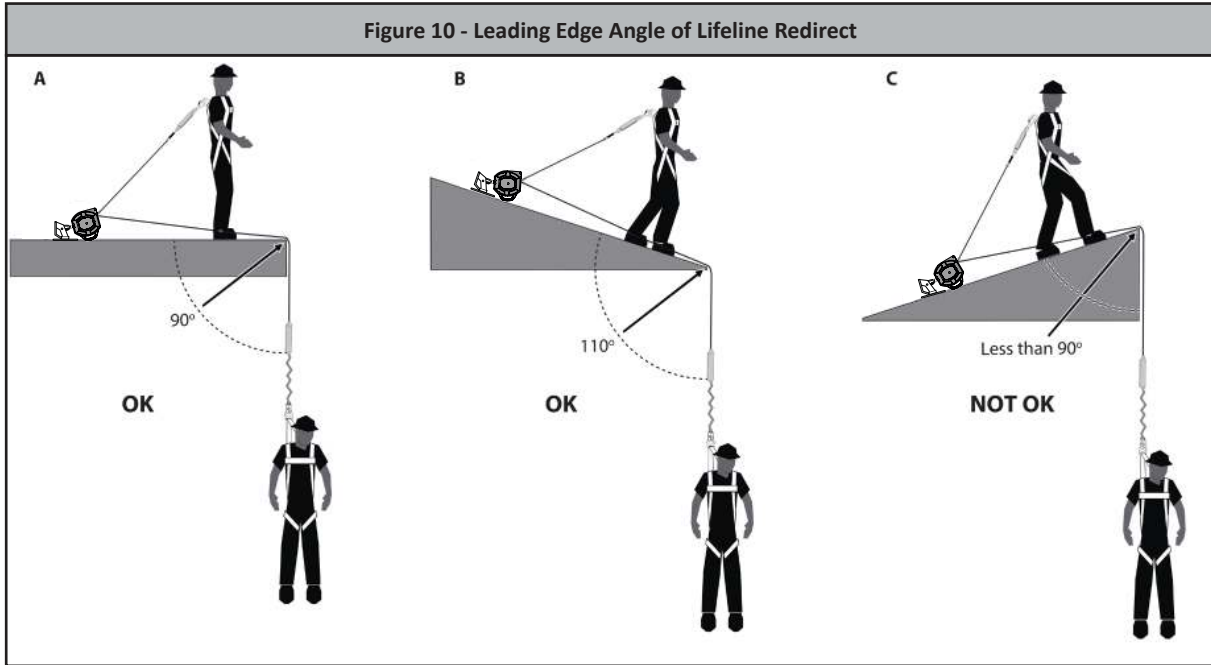

5.4 Edge Conditions: Leading Edge conditions vary, and may be composed of steel, I-beams with purlins, steel deck, metal roofing, or poured concrete or cinder block as shown in Figure 11.

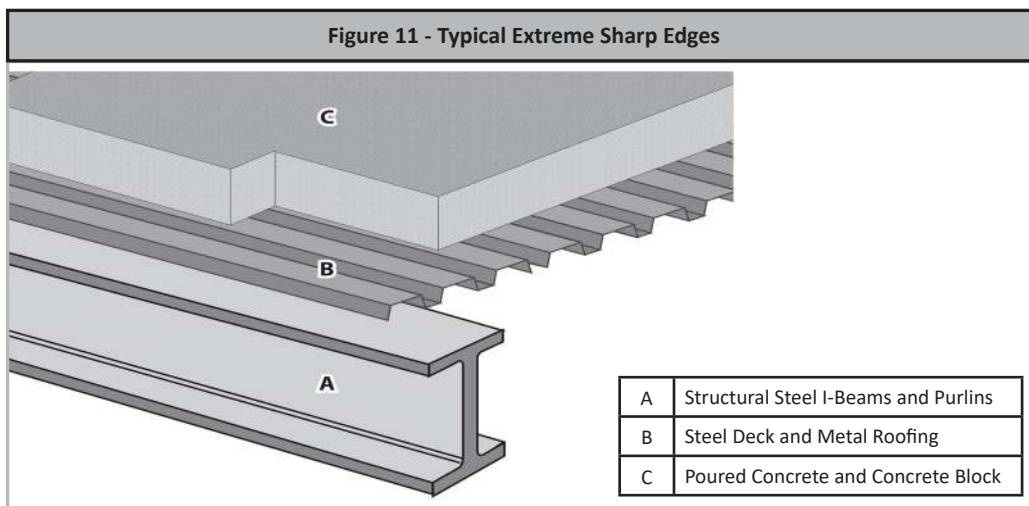

Examples not intended to depict the full extent of all hazardous sharp edges found on job sites for the user to identify and avoid.

5.5 Incorrect Use: Additional factors to avoid, shown in Figure 12:

Do not allow the lifeline to drape over and edge during normal work as this may abrade, damage, or otherwise compromise the lifeline.

Do not attach the anchor on one side of an opening and work on the other side, as this creates multiple possible leading edges and potential swing fall hazards.

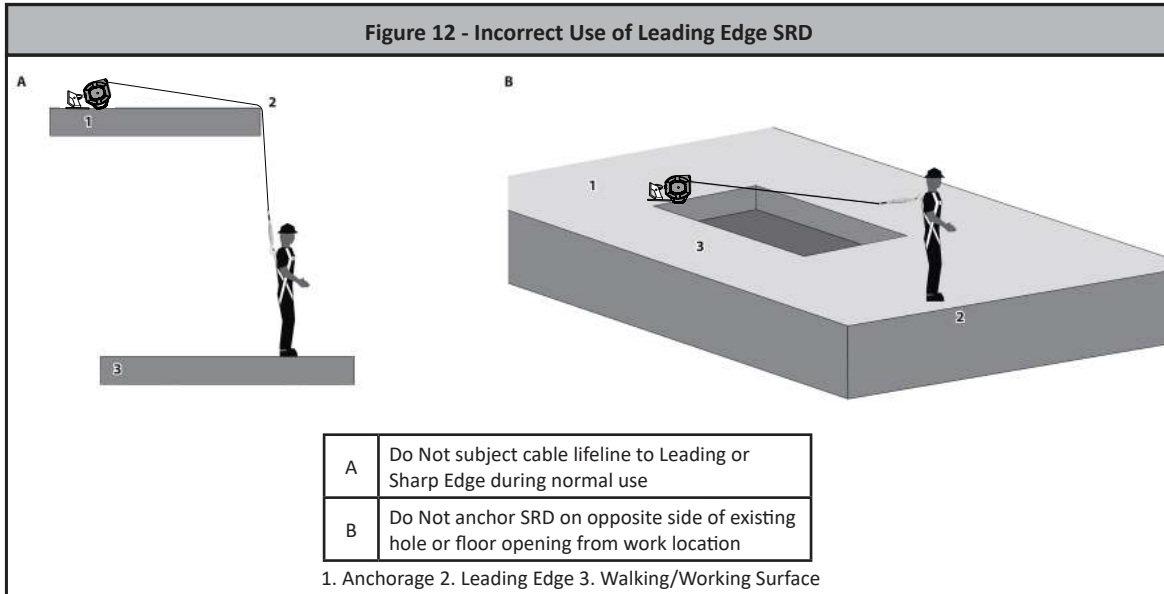

5.6 Operation of the SRD: Before each use, inspect the SRD, see Section 7 for inspection instructions.

5.6.1 Locking Mechanism: The SRD utilizes an acceleration based locking mechanism. The locking function requires a certain payout rate during a fall event to function correctly. Certain situations, confined or cramped spaces, shifting footing such as sand, gravel, grain, or a sloped surface may not allow the lifeline to reach sufficient speed to activate the lock mechanism. A clear path is required to assure positive locking of the SRD. Ensure the lock is functioning properly. Pull the lifeline out a short distance and give it a sharp tug. The lifeline must lock. If it fails to lock, remove it from service immediately. Ensure the work zone remains within stated parameters. Beware of Leading Edge hazards.

DO NOT attach an additional shock absorbing lanyard or similar device between the SRD housing and the anchorage.

5.6.2 Fall Arrest Impact Indicator: The primary fall arrest impact indicator is the load-indicating leg-end connector. The connector will display a red band if it has been subjected to fall arrest, or equal, forces, as shown in Figure 13. The auxiliary Energy Absorber (EA) installed immediately above the leg end carabiner is the secondary indicator. If the EA shows any sign of damage, torn or ripped cover, frayed thread, burns or trauma of any kind, remove the unit from service and tag it as “UNUSABLE”.

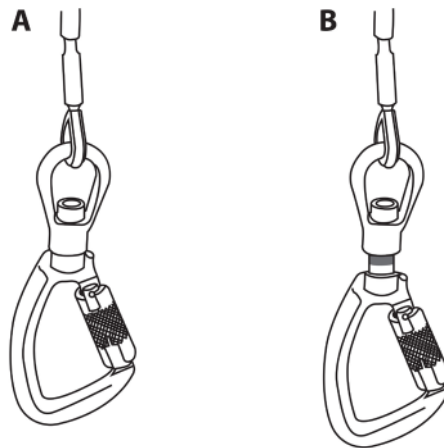

Figure 13: Inspecting SRL Load-Indicating Leg-end Connector

A	Regular Safe Operating Condition of Swivel Leg-end Connector
B	Visual Indicator Exposed on Connector - Remove SRL from Service

5.6.3 Inspect the Cable: The SRD lifeline is steel cable, and subject to certain hazards. Inspect the lifeline before each use for the conditions as described in Section 7.

5.7 Using the SRD: Do not use the SRD if inspection shows damage or any malfunction. Don the FBH in accordance with the FBH manufacturer's instructions. Follow the instructions contained in this manual and on the labels. Failure to follow instructions may result in serious injury or death. Connect the leg end carabiner to the dorsal D-ring on the FBH. Ensure the carabiner closes and locks. Attach the housing carabiner to the chosen anchorage and ensure the carabiner closes and locks. Ensure all connections are compatible. Normal operation will allow the working length of the lifeline to extend and retract as the worker moves about. A certain amount of tension must remain on the cable at all times to ensure proper operation of the internal brake. Do not allow the lifeline to become slack. If the lifeline becomes slack, remove the SRD from service for inspection. See Section 7.

Avoid sudden or quick movements during the normal work operation, as this may cause the SRD brake to engage and possibly cause loss of balance and injury or death.

If a fall occurs, the brake will engage and lock the lifeline. The EA will deploy to arrest the fall and limit arrest forces on the user.

- DO NOT extend the lifeline past the operational limit.
- DO NOT allow one SRD lifeline to become tangled or twisted with another SRD lifeline during use.
- DO NOT allow any lifeline to pass under arms or between legs during use.
- DO NOT clamp, knot, or prevent the lifeline from retracting or being taut.
- DO NOT lengthen the SRD by connecting a lifeline or similar component.
- DO NOT allow the lifeline to remain outside the housing when not in use.
- DO NOT allow the lifeline to freewheel back into the housing. Use a tag line to maintain tension and rewind the lifeline during periods of inactivity. Use the tag line to retrieve the leg end connector for the next use.
- DO NOT leave the tag line connected to the leg end connector when using the SRD for fall protection.

5.8 After A Fall: A fall event over an edge may require special rescue equipment and measures. Ensure a written rescue plan, method and system is in place and readily available to all users for rapid response. Ensure all users are trained in rescue procedures. If a fall event occurs, remove it from service, and store it separately. Remove from service any unit that has been subjected to fall arrest forces or that exhibits damage consistent with such forces. For questions, contact FallTech.

6.0 Maintenance, Service and Storage

6.1 Maintenance: Ensure the SRD is kept free of excess paint, grease, dirt or other contaminants as this may cause to cable or retracting mechanism to malfunction. Ensure no debris enters the housing through the cable access port. Clean the exterior of the unit as required with a detergent/water solution. Avoid water other corrosion causing elements to enter the housing. After cleaning, pull the lifeline all the way out, allow the unit to air dry, then retract the lifeline into the unit. Do not allow the lifeline to freewheel back into the housing. Clean labels as required.

DO NOT use heat to dry.

DO NOT attempt to disassemble the SRD.

6.2 Service: If service is required for any reason; inspection failure, impact loaded, any type of malfunction, tag the unit as "UNUSABLE", store separately, and contact FallTech at 800-719-4619 to receive a Return Authorization number or to locate the nearest FallTech Service Center. The SRD is not user repairable. Only the manufacturer, or a repair facility authorized in writing, may make repairs to the SRD. This SRD is designed to be used installed in an anchor cradle or attached overhead. While it may be used horizontally on a flat surface, the user may encounter a situation where the lifeline will not retract all the way due to misalignment and bunching up on the drum. If this happens, hang the SRD from a height sufficient to allow the full working length of the lifeline to be pulled off the drum, then allow the SRD to retract the lifeline completely. Maintain tension on the lifeline. Use a tag line if necessary.

6.3 Storage: Hang the SRD in a cool, dry, clean environment out of direct sunlight. Position the SRD so excess water can drain out. Avoid exposure to chemical or caustic vapors. Thoroughly inspect the SRD after any period of extended storage.

7.0 Inspection

7.1 **Pre-Use User Inspection:** Perform an inspection before each use in accordance with the recommendations in Table 1 below.

Table 1 - Guidelines for Cable SRD Inspection		
Inspection	Pass	Fail
The cable lifeline should extract and retract completely and without faltering and should remain taut under tension without sagging.		
Extract the cable lifeline several inches and apply a firm pull to confirm the SRD locks. The locking should be certain and without skidding. Repeat this lockup at additional places along the lifeline length to confirm the SRD is operating correctly.		
Examine the load indicator on the Energy Absorber to be certain that it has not been loaded, impacted or activated. (see Figure 13 if needed)		
Inspect the entire length of the constituent line up. Review the cable lifeline closely for broken strand wires, welding spatter burns, welding slag, bird caging, kinks and bent strands. Also examine for rust, dirt, paint, grease or oil. Check for damage caused by chemical corrosion or excessive heat as evident with discoloration. See Figure 14 for examples. If any of these conditions exist, remove the SRD from service.		
Check for any missing or loose screws or nuts and any deformed or damaged components.		
Examine the external housing for cracks, breaks or warping.		
Check the external Connector Eye and the Anchorage Carabiner for damage and deformation. The Anchorage Carabiner Gate should open and snap shut easily and smoothly.		
Examine the overall SRD unit for any indications of deterioration or damage.		
All labels must be intact and totally legible (see Section 8).		

Extract all of the cable and check the entire working length for damage caused by chemical corrosion or excessive heat as evident by discoloration (A), bird caging (B), broken wire strands (C), kinks and bent strands (D), see Figure 14. The cable should retract completely without faltering and should remain taut under tension without sagging.

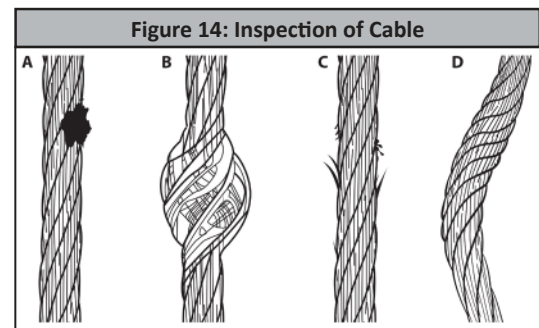

7.2 **Inspection Frequency:** Inspection by a competent person at regular intervals is required. The competent person will use the information in Table 2: SRD Inspection Recommendations, to determine the inspection frequency. Use Table 2 to determine the inspection frequency. Inspection by a factory authorized inspection entity at regular intervals is also required.

Table 2 - SRD Inspection Frequency Recommendations			
Type of Use	Application Examples	Conditions of Use	Inspection Frequency Competent Person
Infrequent to Light Use	Rescue and Confined Space, Factory Maintenance	Good Storage Conditions, Indoor or Infrequent Outdoor use, Room Temperature, Clean Environments	Annually
Moderate to Heavy Use	Transportation, Residential Construction, Utilities, Warehouse	Fair Storage Conditions, Indoor and extended outdoor use, All temperatures, Clean or dusty environments	Semi-annually to Annually
Severe to Continuous Use	Commercial Construction, Oil and Gas, Mining	Harsh Storage Conditions, Prolonged or Continuous outdoor Use, all temperatures, Dirty environments	Quarterly to Semi-annually

8.0 Labels

8.1 Labels: The labels must be present and legible.



800-719-4619 falltech.com

SELF-RETRACTING LIFELINE

MODEL # 727620LE

CAPACITY: 130-310 lbs. Including tools, clothing, etc.

LIFELINE MATERIAL: 7/32" Steel Wire Rope

WORKING LIFELINE LENGTH: 20ft

ANSI Z359.14-2021 Class 2

ARREST DISTANCE: Less than 42"

AVG. ARREST FORCE: <1,350 LBS. MAX

MAX FREE FALL: 5ft

CLEARANCE OVER THE EDGE: 17.5ft

Date of Mfg: See Brass Tag

Serial #: See Brass Tag

SAFE TO USE



REMOVE FROM SERVICE
IF RED APPEARS



DANGER!

⚠ WARNING

Always read and follow the manufacturer's instructions, labels, and warnings before use. Failure to do so can result in serious injury or death. Adhere to the hierarchy of controls described in ANSI Z359.2. Before each use, test the device for locking and retraction, and inspect according to the manufacturer's instructions. Ensure the visual load indicator, a red band immediately above the leg-end connector, is not visible. Ensure adequate clearance exists in fall zone to avoid contact with lower level or obstruction. Limit swing falls by working directly beneath anchor. Elevate anchorage to reduce clearance requirements and to limit risk of damage or failure. Do not connect to an anchor more than 5 feet below the dorsal D-ring. If the unit is subjected to a fall, remove from service immediately. See instruction manual for minimum anchorage strength requirements. Suitable for horizontal use and for use with horizontal lifelines. See instruction manual for additional information.

Class

2

Anchor above or below dorsal D-ring

⚠ DO NOT REMOVE LABEL ⚠

412-06256 Rev A



800-719-4619 falltech.com

SELF-RETRACTING LIFELINE

MODEL # 727630LE

CAPACITY: 130-310 lbs. Including tools, clothing, etc.

LIFELINE MATERIAL: 7/32" Steel Wire Rope

WORKING LIFELINE LENGTH: 30ft

ANSI Z359.14-2021 Class 2

ARREST DISTANCE: Less than 42"

AVG. ARREST FORCE: <1,350 LBS. MAX

MAX FREE FALL: 24"

CLEARANCE OVER THE EDGE: 17.5ft

Date of Mfg: See Brass Tag

Serial #: See Brass Tag

SAFE TO USE



REMOVE FROM SERVICE
IF RED APPEARS



DANGER!

⚠ WARNING

Always read and follow the manufacturer's instructions, labels, and warnings before use. Failure to do so can result in serious injury or death. Adhere to the hierarchy of controls described in ANSI Z359.2. Before each use, test the device for locking and retraction, and inspect according to the manufacturer's instructions. Ensure the visual load indicator, a red band immediately above the leg-end connector, is not visible. Ensure adequate clearance exists in fall zone to avoid contact with lower level or obstruction. Limit swing falls by working directly beneath anchor. Elevate anchorage to reduce clearance requirements and to limit risk of damage or failure. Do not connect to an anchor more than 5 feet below the dorsal D-ring. If the unit is subjected to a fall, remove from service immediately. See instruction manual for minimum anchorage strength requirements. Suitable for horizontal use and for use with horizontal lifelines. See instruction manual for additional information.

Class

2

Anchor above or below dorsal D-ring

⚠ DO NOT REMOVE LABEL ⚠

412-06257 Rev A

Overhead Anchorage 727620LE/727630LE Class 2 SRL

Clearance Chart - Read Instruction Manual for Complete Details

Lateral Offset Distance, ft (Y)

SRD Anchorage Height Above Dorsal D-ring (X)	Lateral Offset Distance, ft (Y)																					
	0	2	4	6	8	10	12	14	16	18	20	22	24	26	28	30	32	34	36	38	40	42
30 Feet	6.0	6.5	6.5	7.0	7.5	8.0	8.5	9.0	9.5	10.0	11.0	12.5	13.5									
25 Feet	6.0	6.5	6.5	7.0	7.5	8.0	8.5	9.0	9.5	10.0	11.0	12.0	13.5	14.5								
20 Feet	6.0	6.5	6.5	7.0	7.5	8.0	8.5	9.5	10.5	12.0	13.0	14.5	16.0									
15 Feet	6.0	6.5	7.0	7.5	8.0	8.5	9.5	10.5	12.0	13.0	14.5	16.0	18.0									
10 Feet	6.0	6.5	7.0	8.0	9.0	10.5	12.0	13.5	15.0	17.0	18.5	20.5										
5 Feet	6.0	6.5	7.5	9.0	10.5	12.5	14.0	16.0	18.0	20.0	22.0	24.0										
0 Feet	6.0	6.0	10.0	12.0	14.5	16.0	18.0	20.0	22.0	24.0	26.0	28.0										

Minimum Required Fall Clearance, ft (Z) - Includes 1.5 foot Safety Margin
See diagram for illustration of axes X, Y and Z.

XX.X = Allowable Work Area

XX.X = Not Allowed Work Area
Unless swing fall path is free of obstructions
⚠ WARNING: WORKING IN THIS AREA MAY RESULT IN SERIOUS INJURY OR DEATH

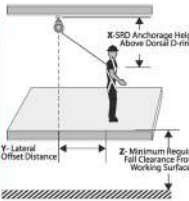

Non-Overhead Anchorage 727620LE/727630LE Class 2 SRL

Clearance Chart - Read Instruction Manual for Complete Details

Lateral Offset Distance, ft (Y)

Set-Back Distance, ft (X)	Lateral Offset Distance, ft (Y)																					
	0	2	4	6	8	10	12	14	16	18	20	22	24	26	28	30	32	34	36	38	40	42
0 Feet	19.0	19.5	20.0	20.5	21.0	21.5	22.0	22.5	23.0	23.5	24.0	24.5	25.0	25.5	26.0	26.5	27.0	27.5	28.0	28.5	29.0	29.5
5 Feet	19.0	19.0	20.0	20.5	21.0	21.5	22.0	22.5	23.0	23.5	24.0	24.5	25.0	25.5	26.0	26.5	27.0	27.5	28.0	28.5	29.0	29.5
10 Feet	19.0	19.0	20.0	20.5	21.0	21.5	22.0	22.5	23.0	23.5	24.0	24.5	25.0	25.5	26.0	26.5	27.0	27.5	28.0	28.5	29.0	29.5
15 Feet	19.0	19.0	20.0	20.5	21.0	21.5	22.0	22.5	23.0	23.5	24.0	24.5	25.0	25.5	26.0	26.5	27.0	27.5	28.0	28.5	29.0	29.5
20 Feet	19.0	19.0	20.0	20.5	21.0	21.5	22.0	22.5	23.0	23.5	24.0	24.5	25.0	25.5	26.0	26.5	27.0	27.5	28.0	28.5	29.0	29.5
25 Feet	19.0	19.0	20.0	20.5	21.0	21.5	22.0	22.5	23.0	23.5	24.0	24.5	25.0	25.5	26.0	26.5	27.0	27.5	28.0	28.5	29.0	29.5
30 Feet	19.0	19.0	20.0	20.5	21.0	21.5	22.0	22.5	23.0	23.5	24.0	24.5	25.0	25.5	26.0	26.5	27.0	27.5	28.0	28.5	29.0	29.5

Minimum Required Fall Clearance, ft (Z) - Includes 1.5 foot Safety Margin
See diagram for illustration of axes X, Y and Z.

XX.X = Allowable Work Area

XX.X = Not Allowed Work Area
Unless swing fall path is free of obstructions
⚠ WARNING: WORKING IN THIS AREA MAY RESULT IN SERIOUS INJURY OR DEATH

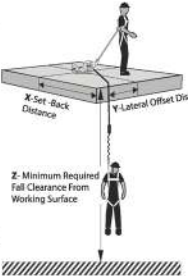



Item # 412-06348 rev A

MSRD08 Rev D

102022

16

8.0 Labels

8.1 Labels: The labels must be present and legible.



800-719-4619 falltech.com

SELF-RETRACTING LIFELINE

MODEL# 727650LE
 CAPACITY: 130-310 lbs. Including tools, clothing, etc.
 LIFELINE MATERIAL: 7/32" Steel Wire Rope
 WORKING LIFELINE LENGTH: 50ft
 ANSI Z359.14-2021 Class 2
 ARREST DISTANCE: Less than 42"
 AVG. ARREST FORCE: <1,350 LBS. MAX
 MAX FREE FALL: 5ft
 CLEARANCE OVER THE EDGE: 18.5ft

Date of Mfg: See Brass Tag
 Serial #: See Brass Tag

SAFE TO USE

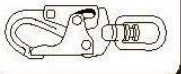

**REMOVE FROM SERVICE
IF RED APPEARS**



DANGER!

⚠ WARNING

Always read and follow the manufacturer's instructions, labels, and warnings before use. Failure to do so can result in serious injury or death. Adhere to the hierarchy of controls described in ANSI Z359.2. Before each use, test the device for locking and retraction, and inspect according to the manufacturer's instructions. Ensure the visual load indicator, a red band immediately above the leg-end connector, is not visible. Ensure adequate clearance exists in fall zone to avoid contact with lower level or obstruction. Limit swing falls by working directly beneath anchor. Elevate anchorage to reduce clearance requirements and to limit risk of damage or failure. Do not connect to an anchor more than 5 feet below the dorsal D-ring. If the unit is subjected to a fall, remove from service immediately. See instruction manual for minimum anchorage strength requirements. Suitable for horizontal use and for use with horizontal lifelines. See instruction manual for additional information.

Class
2

Anchor above or
below dorsal D-ring

⚠ DO NOT REMOVE LABEL ⚠

412-06258 Rev A

Overhead Anchorage 727650LE Class 2 SRL
Clearance Chart - Read Instruction Manual for Complete Details

Lateral Offset Distance, ft (Y)

SRL Anchorage Height Above Dorsal D-Ring (X)	Lateral Offset Distance, ft (Y)										
	0	4	6	8	10	12	14	16	18	20	24
80 Feet	8.0	8.0	7.8	7.8	8.1	10.3	11.3	12.6	14.0	15.0	16.6
40 Feet	8.0	8.0	7.8	8.0	8.3	11.0	12.0	13.6	15.0	16.0	17.6
20 Feet	8.0	8.0	7.8	8.0	10.0	10.0	12.0	14.0	16.0	17.0	18.0
10 Feet	8.0	8.0	8.0	8.0	12.0	14.0	16.0	18.0	20.0	22.0	24.0
0 Feet	8.0	7.8	8.0	10.0	10.0	12.0	14.0	16.0	18.0	20.0	22.0

Minimum Required Fall Clearance, ft (Z) - Includes 1.6 foot Safety Margin
 See diagram for illustration of axes X, Y and Z

XXX = Allowable Work Area

XXX = Not Allowed Work Area
 Unless using fall path is free of obstructions
A WARNING WORKING IN THIS AREA MAY RESULT IN SERIOUS INJURY OR DEATH

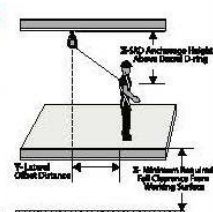

Non-Overhead Anchorage 727650LE Class 2 SRL
Clearance Chart - Read Instruction Manual for Complete Details

Lateral Offset Distance, ft (Y)

SRL Anchor Distance, ft (X)	Lateral Offset Distance, ft (Y)										
	0	4	6	8	10	12	14	16	18	20	24
10 Feet	19.0	23.0	27.0	31.0	34.0	38.0	42.0	47.0	51.0	56.0	61.0
20 Feet	19.0	23.0	27.0	30.0	34.0	37.0	40.0	45.0	49.0	54.0	59.0
30 Feet	19.0	23.0	27.0	30.0	34.0	37.0	40.0	45.0	49.0	54.0	59.0
40 Feet	19.0	23.0	27.0	30.0	34.0	37.0	40.0	45.0	49.0	54.0	59.0
50 Feet	19.0	23.0	27.0	30.0	34.0	37.0	40.0	45.0	49.0	54.0	59.0

Minimum Required Fall Clearance, ft (Z) - Includes 1.5 foot Safety Margin
 See diagram for illustration of axes X, Y and Z

XXX = Allowable Work Area

XXX = Not Allowed Work Area
 Unless using fall path is free of obstructions
A WARNING WORKING IN THIS AREA MAY RESULT IN SERIOUS INJURY OR DEATH

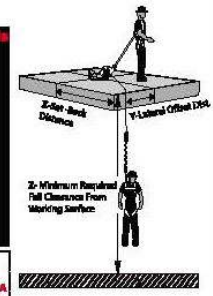



Item # 412-06349 rev A

9.0 Definitions

The following are general definitions of fall protection terms as defined by ANSI Z359.0-2012.

Anchorage - A secure connecting point or a terminating component of a fall protection system or rescue system capable of safely supporting the impact forces applied by a fall protection system or anchorage subsystem.

Anchorage Connector - A component or subsystem that functions as an interface between the anchorage and a fall protection, work positioning, rope access or rescue system for the purpose of coupling the system to the anchorage.

Arrest Distance - The total vertical distance required to arrest a fall. The arrest distance includes the deceleration distance and activation distance.

Authorized Person - A person assigned by the employer to perform duties at a location where the person will be exposed to a fall hazard.

Available Clearance - The distance from a reference point, such as the working platform, to the nearest obstruction that an authorized person might contact during a fall which, if struck, could cause injury.

Capacity - The maximum weight that a component, system or subsystem is designed to hold.

Certification - The act of attesting in writing that the criteria established by these standards or some other designated standard have been met.

Certified Anchorage - An anchorage for fall arrest, positioning, restraint or rescue systems that a qualified person certifies to be capable of supporting the potential fall forces that could be encountered during a fall.

Clearance - The distance from a specified reference point, such as the working platform or anchorage of a fall arrest system, to the lower level that a worker might encounter during a fall.

Clearance Requirement - The distance below an authorized person that must remain clear of obstructions in order to ensure that the authorized person does not make contact with any objects that would cause injury in the event of a fall.

Competent Person - An individual designated by the employer to be responsible for the immediate supervision, implementation and monitoring of the employer's managed fall protection program who, through training and knowledge, is capable of identifying, evaluating and addressing existing and potential fall hazards, and who has the employer's authority to take prompt corrective action with regard to such hazards.

Component - An element or integral assembly of interconnected elements intended to perform one function in the system.

Connecting Subsystem - An assembly, including the necessary connectors, comprised of all components, subsystems, or both, between the anchorage or anchorage connector and the harness attachment point.

Connector - A component or element that is used to couple parts of the system together.

Deceleration Distance - The vertical distance between the user's fall arrest attachment at the onset of fall arrest forces during a fall, and after the fall arrest attachment comes to a complete stop.

Energy (Shock) Absorber - A component whose primary function is to dissipate energy and limit deceleration forces which the system imposes on the body during fall arrest.

Fall Arrest - The action or event of stopping a free fall or the instant where the downward free fall has been stopped.

Fall Hazard - Any location where a person is exposed to a potential free fall.

Free Fall - The act of falling before a fall protection system begins to apply forces to arrest the fall.

Free Fall Distance - The vertical distance traveled during a fall, measured from the onset of a fall from a walking working surface to the point at which the fall protection system begins to arrest the fall.

Harness, Full Body - A body support designed to contain the torso and distribute the fall arrest forces over at least the upper thighs, pelvis, chest and shoulders.

Horizontal Lifeline - A component of a horizontal lifeline subsystem, consisting of a flexible line with connectors or other coupling means at both ends for securing it horizontally between two anchorages or anchorage connectors.

Horizontal Lifeline Subsystem - An assembly, including the necessary connectors, comprised of a horizontal lifeline component and, optionally, of:
a) An energy absorbing component or, b) A lifeline tensioner component, or both. This subsystem is normally attached at each end to an anchorage or anchorage connector. The end anchorages have the same elevation.

Horizontal Lifeline – A component of a horizontal lifeline subsystem, consisting of a flexible line with connectors or other coupling means at both ends for securing it horizontally between two anchorages or anchorage connectors.

Horizontal Lifeline Subsystem – An assembly, including the necessary connectors, comprised of a horizontal lifeline component and, optionally, of:
a) An energy absorbing component or, b) A lifeline tensioner component, or both. This subsystem is normally attached at each end to an anchorage or anchorage connector. The end anchorages have the same elevation.

Lanyard - A component consisting of a flexible rope, wire rope or strap, which typically has a connector at each end for connecting to the body support and to a fall arrester, energy absorber, anchorage connector or anchorage.

Lanyard Connecting Subsystem - An assembly, including the necessary connectors, comprised of a lanyard only, or a lanyard and energy absorber.

Personal Fall Arrest System (PFAS) - An assembly of components and subsystems used to arrest a person in a free fall.

Positioning - The act of supporting the body with a positioning system for the purpose of working with hands free.

Positioning Lanyard - A lanyard used to transfer forces from a body support to an anchorage or anchorage connector in a positioning system.

Qualified Person - A person with a recognized degree or professional certificate and with extensive knowledge, training and experience in the fall protection and rescue field who is capable of designing, analyzing, evaluating and specifying fall protection and rescue systems.

Self-Retracting Device (SRD) - A device that contains a drum wound line that automatically locks at the onset of a fall to arrest the user, but that pays out from and automatically retracts onto the drum during normal movement of the person to whom the line is attached.

Snaphook - A connector comprised of a hook-shaped body with a normally closed gate or similar arrangement that may be opened to permit the hook to receive an object and, when released, automatically closes to retain the object.

Swing Fall - A pendulum-like motion that occurs during and/or after a vertical fall. A swing fall results when an authorized person begins a fall from a position that is located horizontally away from a fixed anchorage.

APPENDIX A

Table 1A: Specifications for Leading Edge Contractor SRL					
Model #	Lifeline Material	Working Length, Weight, and Housing Size	Materials and Specifications	Capacity and Standards	Image
727620LE	7/32" (5.6mm) Diameter 7X19 Galvanized Steel Cable	20 ft (6.1 m) 18.4 lbs (8.3 kg) 10" diameter (254 mm diameter)	Housing: Glass Reinforced Nylon	Single User Capacity: 130 to 310 lbs. (59 to 141 kg) ANSI Z359.14-2021 Class 2 OSHA 1926.502 OSHA 1910.66	
727630LE		30 ft (9.1 m) 19.4 lbs (8.8 kg) 10" diameter (254 mm diameter)	Anchorage Carabiner: 5,000 lbs (22.2 kN) with 3,600 lbs (16 kN) Gate Strength		
727650LE		50 ft (15.3 m) 25.7 lbs (11.7 kg) 11" diameter (279 mm diameter)	Steel Swivel Snap Hook: 5,000 lbs (22.2 kN) with 3,600 lbs (16 kN) Gate Strength		

Table 1B: FallTech Leading Edge Contractor Class 2 SRL ANSI Performance Attributes							
Part #s and Conditions		Typical FallTech Performance			ANSI Performance Requirements		
Part #	Anchorage Condition	Arrest Distance	Average Arrest Force	Maximum Arrest Force	Maximum Arrest Distance	Average Arrest Force *Conditioned	Maximum Arrest Force
727620LE 727630LE	Overhead Non-Leading Edge	35" (0.9 m)	1,035 lbf (4.6 kN)	1,724 lbf (7.7 kN)	42" (1.1 m)	1,575 lbf (7.0 kN)	1,800 lbs (8.0 kN)
	Leading Edge Condition, Foot-Level with 5' (1.5m) Setback	121" (3.1 m)	1,235 lbf (5.5 kN)	1,728 lbf (7.7 kN)	N/A	N/A	
	Leading Edge Condition, Foot-Level with 0' Setback	136" (3.5 m)	975 lbf (4.3 kN)	1,627 lbf (7.2 kN)	N/A	N/A	
727650LE	Overhead Non-Leading Edge	42" (1.1 m)	926 lbf (4.1 kN)	1,567 lbf (7.0 kN)	42" (1.1 m)	1,575 lbf (7.0 kN)	
	Leading Edge Condition, Foot-Level with 5' (1.5 m) Setback	130" (3.3 m)	1,255 lbf (5.6 kN)	1,791 lbf (8.0 kN)	N/A	N/A	
	Leading Edge Condition, Foot-Level with 0' Setback	137" (3.5 m)	949 lbf (4.2 kN)	1,622 lbf (7.2 kN)	N/A	N/A	