

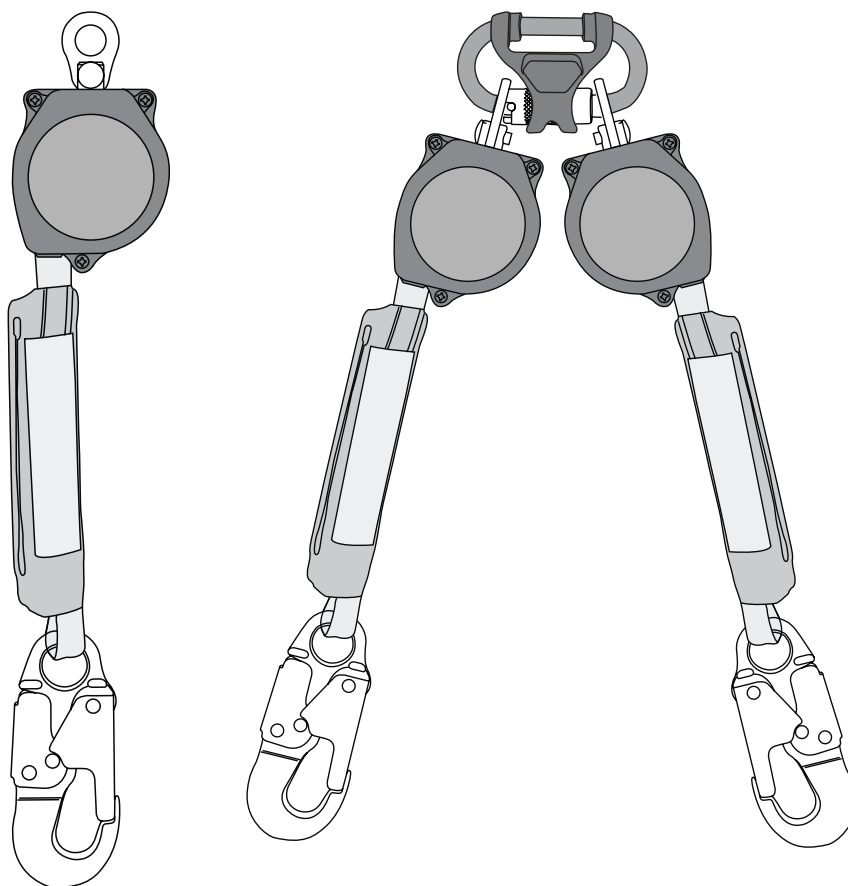

## 6' DuraTech™ Mini SRL-P

### User Instruction Manual



This manual is intended to meet the Manufacturer's Instructions as required by the American National Standards Institute (ANSI) Z359 and should be used as part of an employee training program as required by the Occupational Safety and Health Administration (OSHA).

## Table of Contents

1.0	Warnings and Important Information .....	3
2.0	Description .....	4
3.0	Application .....	6
4.0	System Requirements .....	7
5.0	Installation and Use .....	8
6.0	Maintenance, Service, and Storage .....	13
7.0	Inspection .....	13
8.0	Labels .....	15
9.0	Definitions .....	16
	Appendix A .....	18

For purposes of this manual, the 6' DuraTech Mini Self-retracting Lifeline in all iterations may be referred to collectively as the 6' DuraTech Mini, the Mini, the SRL-P, the DuraTech Mini SRL, the SRL, the equipment, the device, the product, or the unit.

Throughout this manual, ANSI Z359.0-2012 fall protection words, phrases and terms are used. These terms are all formally defined in Section 9 of this manual.

## 1.0 Warnings and Important Information

### **WARNING**

- Avoid moving machinery, thermal, electrical, and/or chemical hazards as contact may cause serious injury or death.
- Avoid swing falls.
- Follow the weight restrictions and recommendations in this manual.
- Remove from service any equipment subjected to fall arrest forces.
- Remove from service any equipment that fails inspection.
- Do not alter or intentionally misuse this equipment.
- Consult FallTech when using this equipment in combination with components or subsystems other than those described in this manual.
- Do not connect rebar hooks, large carabiners, or large snap hooks to the FBH dorsal D-rings as this may cause a roll-out condition and/or unintentional disengagement.
- Use caution when performing arc welding. Arc flash from arc welding operations, including accidental arcs from electrical equipment, can damage equipment and are potentially fatal.
- Examine the work area. Be aware of the surroundings and workplace hazards that may impact safety, security, and the functioning of fall arrest systems and components.
- Hazards may include, but are not limited to, cable or debris tripping hazards, equipment failures, personnel mistakes, or moving equipment such as carts, barrows, fork lifts, cranes, or dollies. Do not allow materials, tools, or equipment in transit to contact any part of the fall arrest system.
- Do not work under suspended loads.

### **IMPORTANT**

This product is part of a personal fall arrest, restraint, work positioning, suspension, or rescue system. A Personal Fall Arrest System (PFAS) is typically composed of an anchorage and a Full Body Harness (FBH), with a connecting device, i.e., a Shock Absorbing Lanyard (SAL), or a Self-Retracting Lanyard (SRL), attached to the dorsal D-ring of the FBH.

These instructions must be provided to the worker using this equipment. The worker must read and understand the manufacturer's instructions for each component or part of the complete system. Manufacturer's instructions must be followed for proper use, care, and maintenance of this product. These instructions must be retained and be kept available for the worker's reference at all times. Alterations or misuse of this product, or failure to follow instructions, may result in serious injury or death.

A Fall Protection Plan must be on file and available for review by all workers. It is the responsibility of the worker and the purchaser of this equipment to assure that users of this equipment are properly trained in its use, maintenance, and storage. Training must be repeated at regular intervals. Training must not subject the trainee to fall hazards.

Consult a doctor if there is reason to doubt your fitness to safely absorb the shock of a fall event. Age and fitness seriously affect a worker's ability to withstand falls. Pregnant women or minors must not use this equipment.

ANSI limits the weight of fall protection equipment users to a maximum of 310 lbs. Products in this manual may have a rated capacity exceeding ANSI capacity limits. Heavy users experience more risk of serious injury or death due to falls because of increased fall arrest forces placed on the user's body. In addition, the onset of suspension trauma after a fall event may be accelerated for heavy users.

The user of the equipment discussed in this manual must read and understand the entire manual before beginning work.

NOTE: For more information consult the ANSI Z359 body of standards.

## 2.0 Description

The FallTech<sup>(R)</sup> DuraTech™ Mini SRL-P is a personal self-retracting device for those working at height and may be subject to fall hazards. This product is not suitable for applications with leading edge exposures where the lifeline of this device may come in contact with an edge during a fall event. This product is a personal SRL and may be used with the SRL housing side connected to the anchor or connected to the full body harness. Contact FallTech for more information or product selection questions.

This manual includes one Appendix containing figures and tables specific to the DuraTech Mini SRL-P discussed in this manual.

The SRL discussed in this manual may be attached to an overhead anchorage, i.e., from directly over the user's head, or to an anchorage at a maximum of 5' below the user's FBH dorsal D-ring. Below D-ring tie-off is outside the scope of ANSI Z359 and is only allowed when no edge hazards are present. At no point during a fall shall the lifeline be loaded over any edge.

As shown in Figure 1 below, the DuraTech Mini has a nylon housing that contains a Dyneema<sup>(R)</sup> synthetic lifeline wound onto a spring tensioned drum. The DuraTech Mini lifeline is equipped with an energy absorber and a leg-end connector. When the user is attached, the lifeline extends and retracts with the user movement, automatically maintaining taut lifeline. If a fall occurs, a centrifugal pawl system engages, stopping the lifeline payout. Then, the inline Energy Absorber (EA) will deploy, gradually slowing and arresting the fall.

See Table 1A in Appendix A for product, material, and performance specifications.

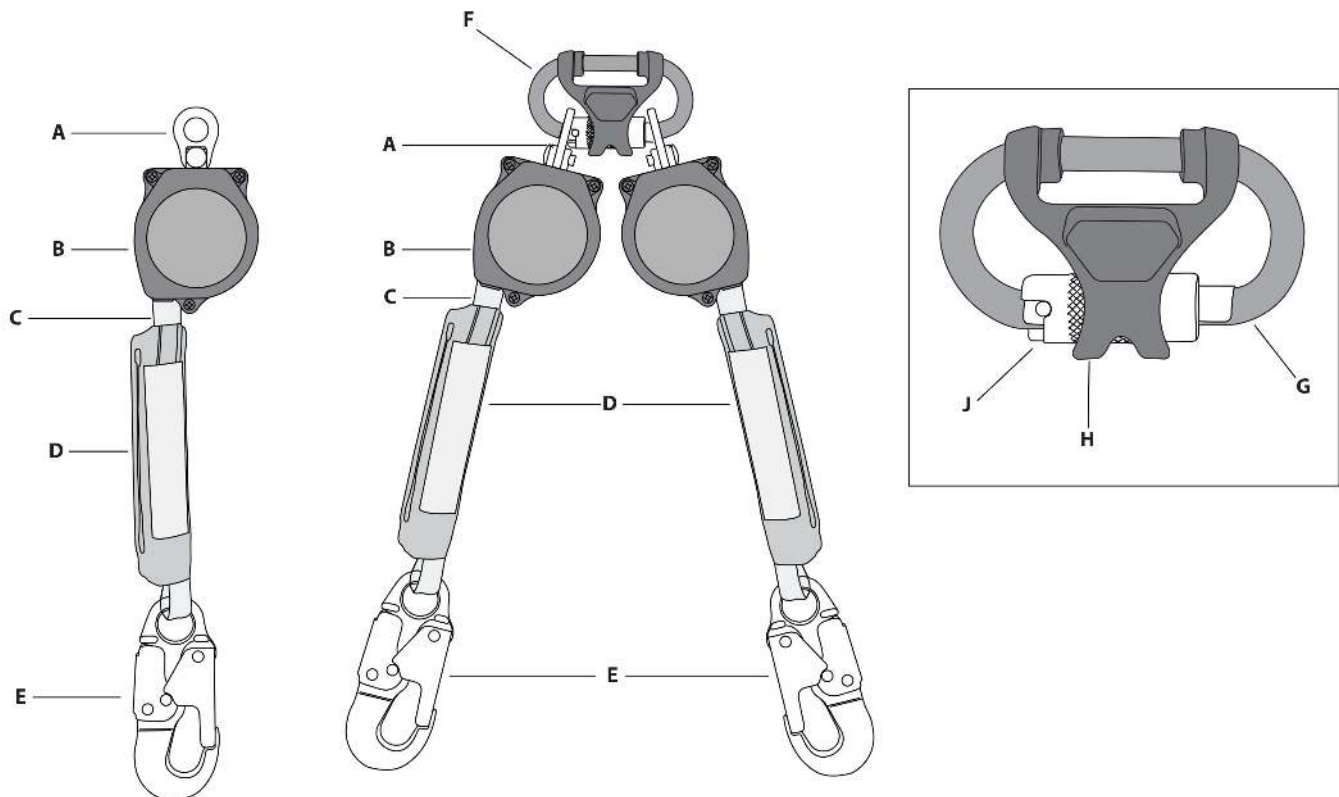

**Figure 1: About DuraTech Mini SRLs**

<b>A</b>	Integral Swivel Eye	<b>F</b>	Triple-lock Carabiner
<b>B</b>	Unit Housing	<b>G</b>	Carabiner Body
<b>C</b>	Web Lifeline	<b>H</b>	Alignment Clip
<b>D</b>	Energy Absorber	<b>J</b>	Triple-lock Gate
<b>E</b>	Leg-end Connector		

**2.1 American National Standards Institute (ANSI) and Occupational Safety and Health Administration (OSHA):** The SRD discussed in this manual meets the standards of ANSI Z359.14-2021, ANSI A10.32-2012, and Occupational Safety and Health Administration (OSHA) regulations 1926.502 and 1910.140. ANSI requires SRDs be classified according to the type of usage the user would be exposed to, and are tested either as Class 1 or Class 2. Dynamic performance means that the SRD is installed in a testing drop tower. A test weight is attached to the SRD and then dropped. Test results are recorded.

Parameters recorded are:

- Arrest Distance (AD)
- Average Arrest Force (AAF)
- Maximum Arrest Force (MAF)

The Arrest Distance is the total vertical distance required to arrest a fall. The Arrest Distance includes the deceleration distance and the activation distance. The Average Arrest Force is the average of the forces applied to the body and the anchorage by the fall protection system. The Maximum Arrest Force is the maximum amount of force that may be applied to the body and the anchorage by the fall protection system. In addition to the above tests conducted in ambient conditions, the units must be retested for average and peak forces under certain environmental conditions, where the units are cooled, then tested, heated, then tested, or saturated in water and tested again. Separate units may be used for each test. All test results are recorded.

This test data is then used to establish the basis for fall clearance guidelines published in the user instruction manual.

**Class 1 and 2:** Class 1 devices shall be used only on overhead anchorages and shall be subjected to a maximum free fall of 2 feet (0.6 m) or less. Class 2 devices are intended for applications where an overhead anchorage may not be available or feasible and be subjected to a free fall of no more than 6 feet (1.8 m) over an edge.

To be declared a Class 1 and Class 2 device, ANSI requires an SRD to have an overhead Arrest Distance of less than 42" (1.1 m), an Average Arrest Force of less than 1,350 lbs (6 kN) [1,575 lbs (7 kN) conditioned] and a Maximum Arresting Force of 1,800 lbs (8 kN), for both ambient and conditioned testing.

When dynamically tested in accordance with requirements of ANSI Z359.14-2021, FallTech Class 1 and Class 2 Self-Retracting Devices have an AAF of 1,350 lbs (6 kN) or less and an AD of less than 42" (1.1 m).

***Please see Section 5 of this user instruction manual for how to calculate your Minimum Required Fall Clearance (MRFC)***

***Please see Section 5.2 of this user instruction manual for how to calculate your Minimum Required Fall Clearance (MRFC) using the affixed labels.***

Classification information found on product labels is based on test results. Table 1B in Appendix A provides test performance results for the SRD discussed in this manual. NOTE: Arrest distance is one of several parts of the Minimum Required Fall Clearance (MRFC). MRFC is discussed in detail in Section 5 .

OSHA requires an SRD limit the free fall to 2 feet (0.9 m) or less. If the maximum free fall distance must be exceeded, the employer must document, based on test data, that the maximum arresting force will not be exceeded, and the personal fall arrest system will function properly. Contact FallTech for more information on this testing.

## 3.0 Application

- 3.1 Purpose:** The DuraTech Mini SRL-P is designed to be used as a component in a Personal Fall Arrest System (PFAS), to provide a combination of worker mobility and fall protection as required for inspection work, general construction, maintenance work, oil production, confined space work, etc.
- 3.2 Personal Fall Arrest System:** A PFAS is an assembly of components and subsystems used to arrest a person during a fall event. A PFAS typically consists of an anchorage, a deceleration device such as a Energy Absorbing Lanyard (EAL), a Self-Retracting Device (SRD), or a Fall Arrestor Connecting Subsystem (FACSS), and a properly fitted Full Body Harness (FBH). The SRD discussed in this manual may be used in non-overhead anchorage situations. Maximum permissible free fall in a typical PFAS is 6' (1.8 m). Other applications may be below the D-ring, but no edge exposures are allowed with this product.
- 3.3 Horizontal Lifeline (HLL) and Rail Systems:** The SRL may be attached to rigid and flexible anchors provided that all HLL or rail system applications, installation, and uses are under the supervision of a qualified person.
- 3.4 Rescue:** Ensure a written rescue plan, method, and system is in place and readily available for rapid response. Rescues may require specialized equipment or measures. Rescue operations are beyond the scope of this manual. See ANSI Z359.4.
- 3.5 Application Limits:** Take action to avoid moving machinery, abrasive surfaces, and thermal, electrical, including the arc from welding applications, and chemical hazards as contact may damage the SRL, which may result in serious injury or death. The SRL is not designed for use in restraint, personnel riding, suspension, or work positioning. Rescue applications are beyond the scope of this manual. Do not use the SRL for these applications except as a back-up PFAS.

## 4.0 System Requirements

**4.1 Capacity:** The DuraTech Mini SRL-P is designed for use by a single user with a combined weight of user, tools, clothing, etc., of 130 to 310 lbs. (59 to 141 kg) to comply with ANSI and OSHA.

**4.2 Compatibility Of Connectors:** Connectors are considered to be compatible with connecting elements when they have been designed to work together in such a way that their sizes and shapes do not cause their gate mechanisms to inadvertently open regardless of how they become oriented. Contact FallTech if you have any questions about compatibility. Connectors must be compatible with the anchorage or other system components. Do not use equipment that is not compatible, see Figure 2. Non-compatible connectors may unintentionally disengage. Connectors must be compatible in size, shape, and strength. Self-closing, self-locking connectors are required by ANSI and OSHA.

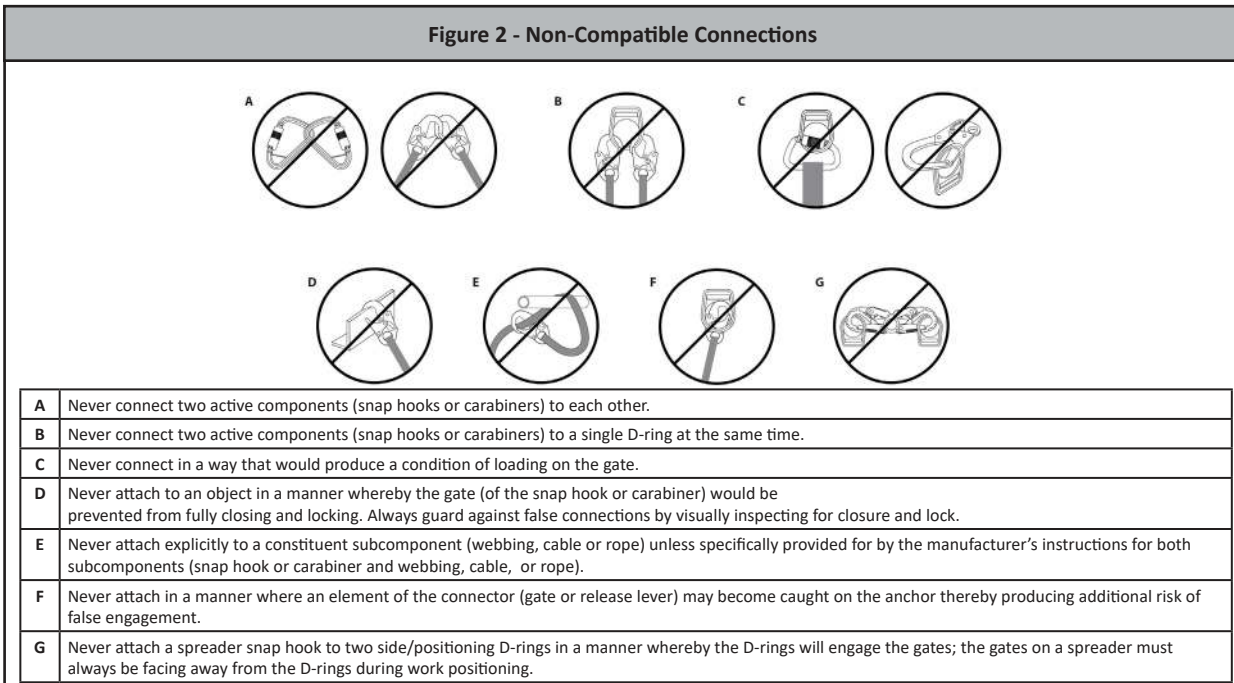

**4.3 Compatibility Of Components:** Equipment is designed for use with approved components and subsystems only. Substitutions or replacements made with non-approved components or subsystems may jeopardize compatibility of equipment and may affect the safety and reliability of the complete system.

**4.4 Making Connections:** Only use self-locking connectors with this equipment. Only use connectors that are suitable to each application. Ensure all connections are compatible in size, shape, and strength. Do not use equipment that is not compatible. Visually ensure all connectors are fully closed and locked. Connectors are designed to be used only as specified in each product's user instructions.

**4.5 Personal Fall Arrest System:** A PFAS is an assembly of components and subsystems used to arrest a person during a fall event. A PFAS is typically composed of an anchorage and a FBH, with an energy absorbing connecting device, i.e., an SAL, an SRL, or a Fall Arrestor Connecting Subsystem (FACSS), connected to the dorsal D-ring of the FBH. PFAS components used in conjunction with this SRL should comply with ANSI Z359 requirements and applicable OSHA regulations.

**4.6 Average Arrest Force and Arrest Distance:** Table 1B in Appendix A provide test data on typical performance attributes of the three principal parameters: Arrest Distance, Average Arrest Force, and Maximum Arrest Force, listed by model number and class. Testing is conducted under various environmental conditions, at ambient temperature, hot, cold, and wet conditions. In manufacturer's tests, worst case performance attributes of the SRL, connected 5' below dorsal D-ring in non-Leading Edge applications are:

130 to 310 lbs. (59 to 141 kg) user	5' Below D-ring
Longest Arrest Distance	82" (2.1 m)
Largest Average Arrest Force	839 lbs (3.7 kN)
Largest Maximum Arrest Force	1,530 lbs (6.8 kN)

The competent person may find this data useful with planning anchorage location and calculating fall arrest loads and distances from the walking/working level to the nearest obstruction or lower level. See Section 5.

**NOTE:** Arrest distance is one part of the Minimum Required Fall Clearance (MRFC). The MRFC is determined by consideration of multiple factors in fall protection. Attachment below the level of the FBH D-ring will require additional fall clearance. MRFC is discussed in detail in Section 5.

**4.7 Personal Fall Arrest System Anchorage Strength:** An anchorage selected for PFAS application must have the strength to sustain a static load applied in the direction permitted by the PFAS of at least:

- a. Two times the maximum arrest force permitted when certification exists, or
- b. 5,000 lbs. (22.2 kN) in the absence of certification.

Select an anchorage location carefully. Consider structural strength, obstructions in the fall path, and swing fall hazards. In certain situations, the qualified person can determine that a given structure is able to withstand the applied MAF of the PFAS with a safety factor of at least two, as required by OSHA.

## 5.0 Installation and Use

### ⚠ WARNING

Do not alter or intentionally misuse this equipment. Consult FallTech when using this equipment in combination with components or subsystems other than those described in this manual. All components or subsystems used with the SRD discussed in this manual must be in compliance with ANSI Z359 and/or OSHA.

Do not use rebar hooks, large carabiners or large snap hooks to connect to the FBH dorsal D-rings or to any small diameter non-compatible anchor point as this may cause a roll-out condition and/or unintentional disengagement.

Avoid sharp and /or abrasive surfaces and edges

**5.1 Single SRL Installation to Full Body Harness:** Installation for Single-leg configuration of the DuraTech Mini to the dorsal D-ring of a full body harness follows the steps listed below:

- Step 1:** Connect an approved carabiner through the swivel eye above the housing
- Step 2:** Connect the approved carabiner with SRL to the dorsal D-ring of the full body harness.
- Step 3:** Connect the leg-end connector of the SRL to the anchorage or anchorage connector. See Figure 3.

Figure 3: Attaching Single-leg Mini to FBH	
A	Anchorage
B	Leg-end Connector
C	Energy Absorber
D	Dyneema Lifeline
E	SRD Body/Housing
F	SRD Integral Swivel Eye
G	Carabiner
H	Dorsal D-ring on FBH

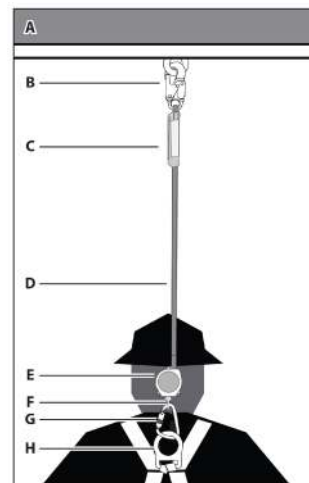

**5.2 Single SRL Installation to Anchorage:** SRLs with large opening rebar hooks for leg-end connectors are not permitted for this type of installation due to incompatibility. See Section 4.2 Installation for Single-leg configuration of the DuraTech Mini to an anchorage or anchorage connector follows the steps listed below. :

- Step 1:** Connect an approved carabiner through the swivel eye above the housing
- Step 2:** Connect the approved carabiner with SRL to the anchorage or anchorage connector.
- Step 3:** Connect the leg-end connector of the SRL to the dorsal D-ring on the full body harness. See Figure 4.

Figure 4: Attaching Single-leg Mini to Anchor	
A	Anchorage
B	Carabiner
C	SRD Integral Swivel Eye
D	SRD Body/Housing
E	Web Lifeline
F	External Shock Absorber
G	Leg End Connector
H	Dorsal D-ring on FBH

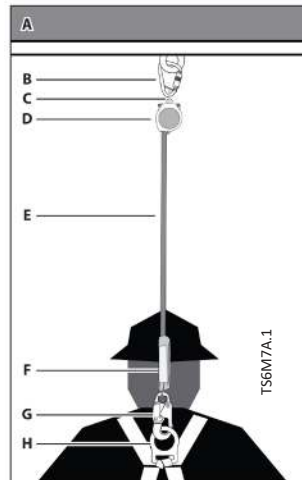

**5.3 Twin SRL Installation to Full Body Harness:** Twin-leg SRLs may be installed through the straps of a full body harness or through the built-in attachment tunnel of a full body harness. Installation for Single-leg configuration of the DuraTech Mini to an anchorage or anchorage connector follows the steps listed below. See Figure 5 below.

Figure 5: Attaching 6' Mini Twin-leg SRL to FBH

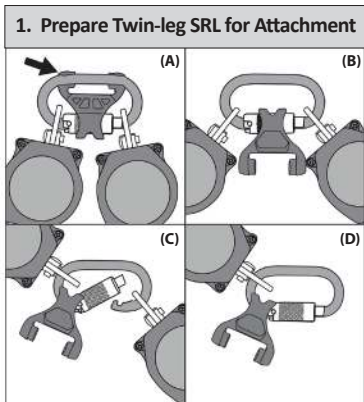

**1. Prepare Single-leg SRD for attachment:**  
**(A)** Open the Alignment Clip from the reverse side by pushing on the top ears to release and **(B)** allow clip to rotate downward; next, **(C)** rotate to one side one SRD unit and the clip then open the triple-lock gate on the Carabiner and remove the other SRD unit. **(D)** Allow gate to close.

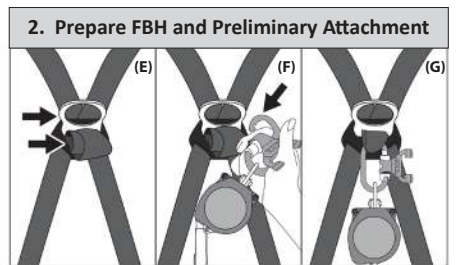

**2. Prepare FBH and Preliminary Attachment:**  
**(E)** Lift the Dorsal D-ring to the up-pointing position then loosen the intersection of the two web straps that pass through the D-ring slot to create slacked loops of about 2" or 3". **(F)** With only one SRD unit still connected to the Carabiner, reopen the gate and insert the nose of the Carabiner into the two intersecting slacked loops; **(G)** allow the gate to close while the Alignment Clip remains positioned on the gate only.

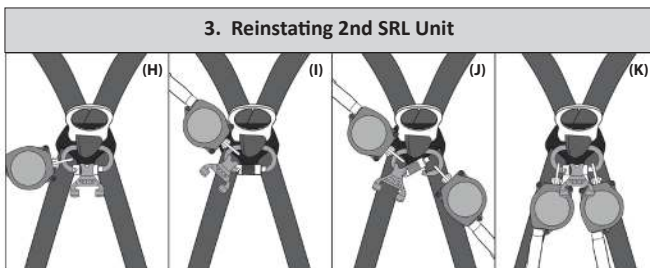

**3. Reinstating 2nd SRD Unit:**  
**(H)** Now rotate the Carabiner and Alignment Clip 1/4 turn to the horizontal position; while keeping slack in the web loops, the gate and clip will end up positioned below the loops. **(I)** Keeping the Carabiner horizontal, rotate the SRD unit away from the gate and slide the Alignment Clip off and away from the gate as well. **(J)** Open the Carabiner gate and insert the nose through the swivel eye of the second SRD unit then allow the gate to close to capture the second SRD. **(K)** Next, reposition the Alignment Clip back onto the gate.

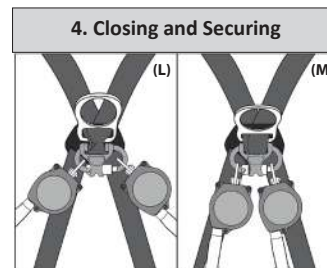

**4. Closing and Securing:**  
**(L)** With the Alignment Clip on the gate, rotate the clip upward; then tightly pinch the two web straps together and insert between the ears of the clip and snap the ears to the body of the Carabiner. **(M)** Lastly, remove the slacked loops from the intersecting web straps by pulling up through the D-ring slot and the D-ring holder. Check the gate for full closure and the Alignment Clip to be securely snapped to the Carabiner body. Don your FBH and adjust as needed for proper fit.

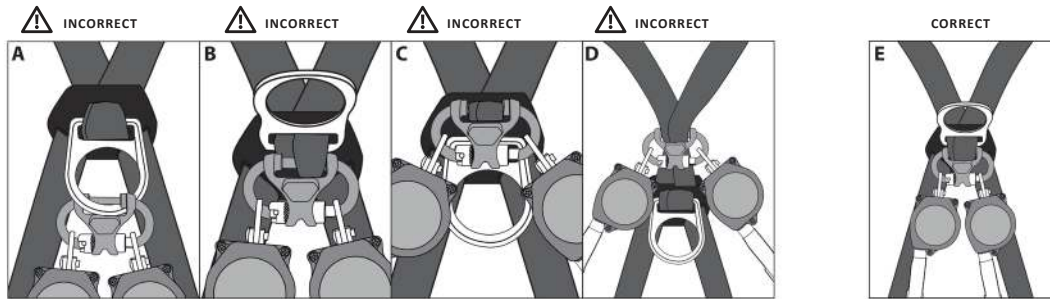

Figure 7B: <b>Incorrect Twin-leg SRL Attachment</b>	
A	<b>DO NOT</b> Attach directly to the Dorsal D-ring
B	<b>DO NOT</b> Attach to only one of the intersecting web straps
C	<b>DO NOT</b> Attach to intersecting web straps over/above the Dorsal D-ring
D	<b>DO NOT</b> Attach anywhere outside the intersecting web straps
E	<b>CORRECT</b> attachment to both intersecting web straps with Dorsal D-ring in the up position

#### 5.4 Attaching to an Anchorage

Examine the work area for possible hazards. Take caution to avoid overhead hazards such as cranes, poles, overhead power cables, and walking/working surface hazards such as power cables, welding leads, air and fluid hoses, including obstruction hazards such as vertical columns and stacks of materials on the lower level. Eliminate hazards where possible.

Ensure the anchorage provides the Minimum Required Fall Clearance (MRFC) in the fall path below the walking/working surface to prevent striking the lower level or an obstruction during a fall event. Take action to avoid swing falls, which occur when the anchorage is not directly above the point where the fall occurs.

Fall clearance and swing falls are subject to variable conditions. Anchor height, lateral movement, and setback distance all affect anchor location with regard to fall clearance and swing falls.

The SRL may be attached to an overhead anchor, i.e., above the user's FBH dorsal D-ring, or a non-overhead anchor, i.e., below the user's FBH dorsal D-ring. A non-overhead anchor may be a maximum of 5' (1.5 m) below the user's FBH dorsal D-ring. Non-overhead anchor locations result in greater possibility of edge hazards. At no point during a fall shall the lifeline be loaded over any edge. Use of a below D-ring anchorages should be as a last resort, when no other anchor option exists. When anchored below the FBH back D-ring, fall events will result in greater fall clearances.

#### 5.5 Using the DuraTech Mini SRL-P

Before each use, inspect the DuraTech Mini in accordance with Section 7. Remove the device from service if the inspection shows damage or any malfunction.

Don the FBH and/or attach the SRL in accordance with the harness manufacturer's instructions.

Follow the instructions contained in this manual and on the labels. Failure to follow instructions may result in serious injury or death.

Connect the leg-end connector to an approved anchorage point or to the full body harness depending on orientation. Ensure the connector closes and locks. In a Twin-leg configuration attach the unused leg end connector to the FBH's lanyard keeper. Ensure all connections are compatible. Normal operation will allow the working length of the lifeline to extend and retract as the worker moves about. When using a Twin-leg configuration, it is possible to move laterally between anchor points with 100% tie-off as shown in Figure 6.

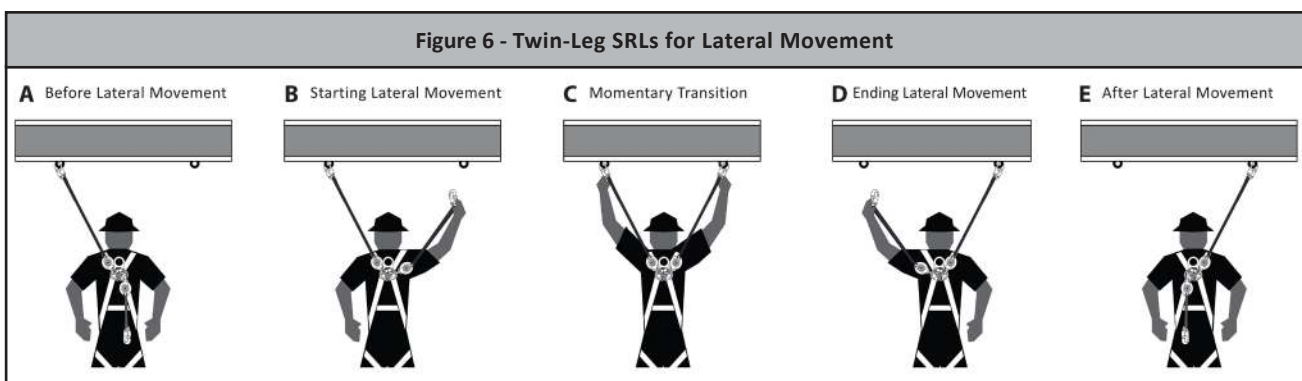

Avoid sudden or quick movements during the normal work operation, as this may cause the SRL pawl system to engage and possibly cause loss of balance, which may cause injury or death. If a fall occurs, the pawl system will engage and lock the lifeline. The EA will deploy to arrest the fall and limit arrest forces on the user.

**5.5.1 Locking Mechanism:** The SRD utilizes an acceleration based locking mechanism. The locking function requires a certain payout rate during a fall event to function correctly. Certain situations, confined or cramped spaces, shifting footing such as sand, gravel, grain, or a sloped surface may not allow the lifeline to reach sufficient speed to activate the lock mechanism. A clear path is required to assure positive locking of the SRD. Ensure the lock is functioning properly. Pull the lifeline out a short distance and give it a sharp tug. The lifeline must lock. If it fails to lock, remove it from service immediately. Ensure the work zone remains within stated parameters.

**5.5.2 Visual Indicator:** The primary fall arrest impact indicator is the energy absorber in the lifeline between the housing and the leg-end connector. Torn stitching, deployment, expansion, or lengthening of the white internal energy absorber webbing is an indication that a fall event has occurred and the unit must be removed from service. Remove from service any unit that fails inspection, including inspection of the fall arrest impact indicator. If you have any questions, contact FallTech.

**5.5.3 After A Fall:** A fall event over an edge may require special rescue equipment and measures. Ensure a written rescue plan, method and system is in place and readily available to all users for rapid response. Ensure all users are trained in rescue procedures. If a fall event occurs, remove it from service, and store it separately. Remove from service any unit that has been subjected to fall arrest forces or that exhibits damage consistent with such forces. For questions, contact FallTech.

**5.5.4 Using the SRD:** Do not use the SRD if inspection shows damage or any malfunction. Don the FBH in accordance with the FBH manufacturer's instructions. Follow the instructions contained in this manual and on the labels. Failure to follow instructions may result in serious injury or death. Connect the SRL-FBH Connector to the dorsal D-ring on the FBH. Ensure the connector closes and locks. Attach the leg-end carabiner to the chosen anchorage and ensure the leg-end connector closes and locks. Ensure all connections are compatible. Normal operation will allow the working length of the lifeline to extend and retract as the worker moves about. A certain amount of tension must remain on the web at all times to ensure proper operation of the internal brake. Do not allow the lifeline to become slack. If the lifeline becomes slack, remove the SRD from service for inspection. See Section 7.

Avoid sudden or quick movements during the normal work operation, as this may cause the SRD brake to engage and possibly cause loss of balance and injury or death.

If a fall occurs, the brake will engage and lock the lifeline. The EA will deploy to arrest the fall and limit arrest forces on the user.

- DO NOT extend the lifeline past the operational limit.
- DO NOT allow one SRD lifeline to become tangled or twisted with another SRD lifeline during use.
- DO NOT allow any lifeline to pass under arms or between legs during use.
- DO NOT clamp, knot, or prevent the lifeline from retracting or being taut.
- DO NOT lengthen the SRD by connecting a lifeline or similar component.
- DO NOT allow the lifeline to remain outside the housing when not in use.

## 5.4 Calculating Minimum Required Fall Clearance

### 5.4.1 DuraTech Mini in Overhead, Non-Leading Edge Anchorage Application [130 to 310 lbs. (59 to 141 kg) user]

The Mini may be used as a standard SRD in an overhead condition, in which the SRD is installed anywhere in the allowable attachment area, which ranges from directly above the user to level with the FBH D-ring, as shown in Figure 7.

The overhead condition minimum required fall clearance (MRFC) is calculated using four metrics, measured from the walking-working surface: SRD Deceleration Distance, D-Ring Shift and Harness Stretch [1 ft (0.3m)], Safety Factor [1.5 ft (0.5m)], and Swing Fall. The diagram in Figure 8 is calculated using the performance data of the SRD and includes all four metrics listed previously to determine the MRFC.

### 5.4.2 DuraTech Mini with a Non-Overhead, Non-Leading Edge Anchorage Application [130 to 310 lbs. (59 to 141 kg) user]

The non-leading edge below D-ring condition minimum required fall clearance (MRFC) is calculated using five metrics, measured from the walking-working surface: SRD Deceleration Distance, D-Ring Shift and Harness Stretch [1 ft (0.3m)], Safety Factor [1.5 ft (0.5m)], Dorsal D-ring Height [5 ft (1.5m)], and Swing Fall. Dorsal D-ring height is added to account for the below D-ring tie-off compared to the overhead condition. The diagram in Figure 8 is calculated using the performance data of the SRD and includes all five metrics listed previously to determine the MRFC. Below D-ring tie-off is outside the scope of ANSI Z359 and is only allowed when no edge hazards are present. At no point during a fall shall the lifeline be loaded over any edge.

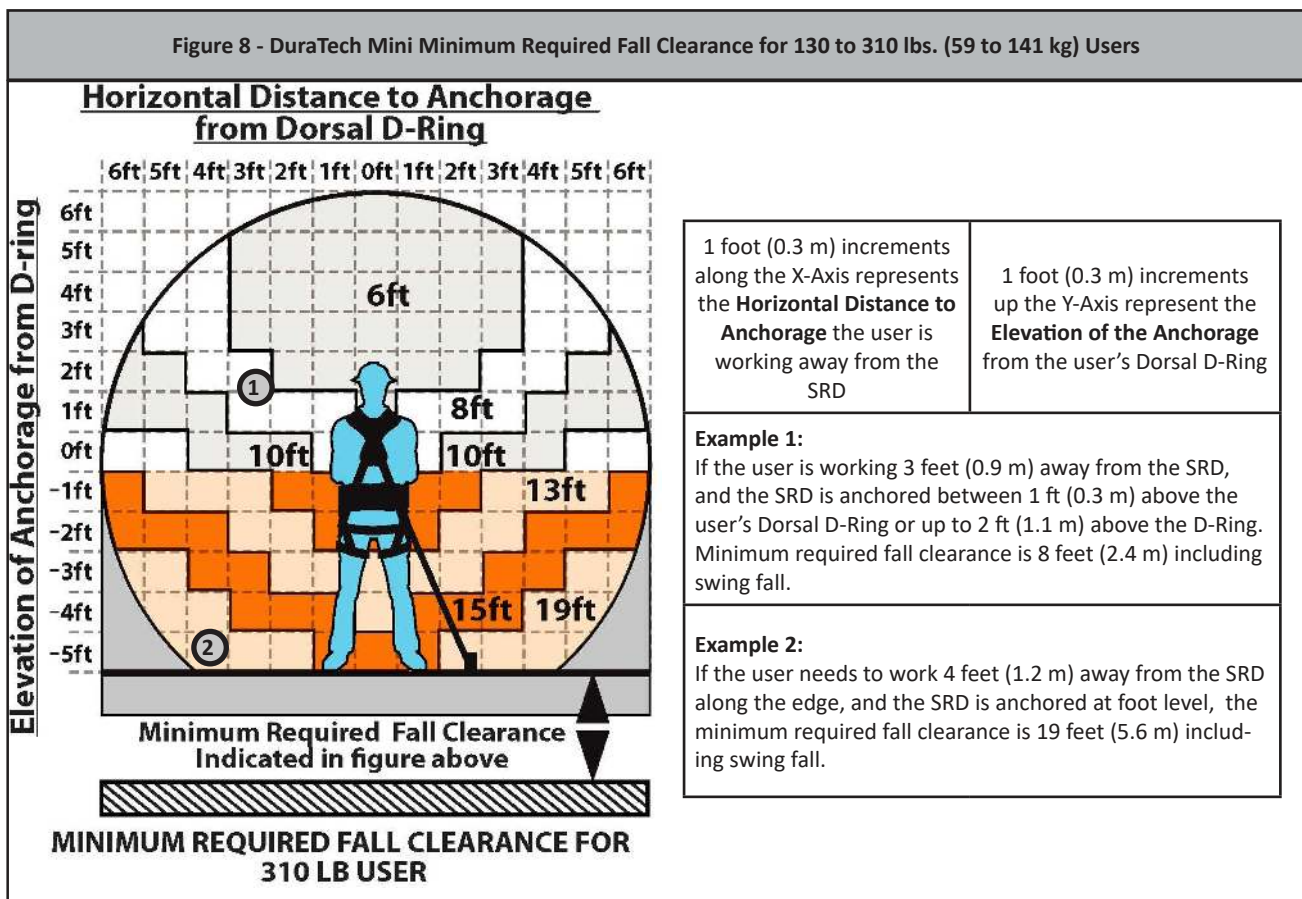
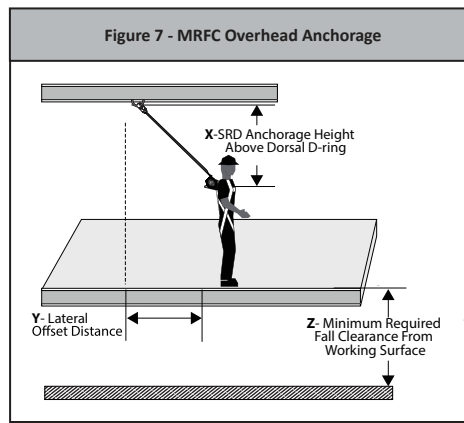

## 6.0 Maintenance, Service, and Storage

**6.1 Maintenance:** Ensure the SRL is kept free of excess paint, grease, dirt or other contaminants as this may cause the lifeline or retracting mechanism to malfunction. Ensure no debris enters the housing. Clean the exterior of the unit as required with a detergent/water solution. Do not allow water or other corrosion causing elements to enter the housing. After cleaning, pull the lifeline all the way out, allow the unit to air dry, then retract the lifeline into the unit. Clean labels as required.

**DO NOT** use heat to dry.

**DO NOT** attempt to disassemble the SRL.

**6.2 Service:** Remove the unit from service if it has been subjected to fall arrest force. Tag the unit as “UNUSABLE” to prevent future use. The SRD is not repairable.

**6.3 Storage:** Store the DuraTech Mini in a cool, dry, clean environment out of direct sunlight. Position the SRL so excess water can drain out. Avoid exposure to chemical or caustic vapors. Thoroughly inspect the SRL after any period of extended storage.

## 7.0 Inspection

**7.1 Pre-Use User Inspection:** Perform an inspection before each use in accordance with the recommendations in Table 1 below.

Table 1: Guidelines for DuraTech SRL Inspection		
Inspection	Pass	Fail
The web lifeline should extract and retract completely and without faltering and should remain taut under tension without sagging.		
Extract the web lifeline several inches and apply a firm pull to confirm the SRD locks. The locking should be certain and without skidding. Repeat this lockup at additional places along the lifeline length to confirm the SRD is operating correctly.		
Examine the energy absorber on the lifeline to be certain that it has not been activated.		
Review the web lifeline closely for wear created by abrasion, tattered yarns, unraveled strands, burns, and cuts. Also examine for knots, rust, dirt, paint, and grease or oil. Check for damage caused by chemical corruption or excessive heat as evident with discoloration. Examine for extreme exposure to sunlight and ultraviolet as demonstrated by desiccation.		
Check for any missing or loose screws or nuts and any deformed or damaged components.		
Examine the external housing for cracks, breaks, or warping.		
Review the integral anchor loop and Connector for damage and deformation. The anchor loop should rotate smoothly and be joined firmly to the housing. The Connector should also rotate smoothly within the anchor loop.		
Examine the overall SRD unit for any indications of deterioration or damage.		
All labels must be intact and totally readable (see Section 8)		

**If an inspection reveals defects or damage to the equipment, remove the equipment from service.**

**7.2 Inspection Frequency:** Inspection by a competent person at regular intervals is required. The competent person will use the information in Table 2, SRL Inspection Recommendations, to determine the inspection frequency. Use Table 2 to determine the inspection frequency. Inspection by a factory authorized inspection entity at regular intervals is also recommended.

Table 2 - ANSI Z359.14-2021 SRL Inspection Recommendations			
Type of Use	Application Examples	Conditions of Use	Inspection Frequency Competent Person
Infrequent to Light Use	Rescue and Confined Space, Factory Maintenance	Good Storage Conditions, Indoor or Infrequent Outdoor use, Room Temperature, Clean Environments	Annually
Moderate to Heavy Use	Transportation, Residential Construction, Utilities, Warehouse	Fair Storage Conditions, Indoor and extended outdoor use, All temperatures, Clean or dusty environments	Semi-annually to Annually
Severe to Continuous Use	Commercial Construction, Oil and Gas, Mining	Harsh Storage Conditions, Prolonged or Continuous outdoor Use, all temperatures, Dirty environments	Quarterly to Semi-annually

**7.3 Inspection Checklist:** Use Table 1: Guidelines for SRL Inspection to inspect the SRL.

**7.4 Inspection Results:** If an inspection reveals defects in or damage to the equipment, inadequate maintenance, or activated fall indicators, remove the equipment from service.

**7.5 Inspection Document:** Record inspection results on the Inspection Record provided below or on a similar document.

<h2 style="margin: 0;">Inspection Record</h2>					
Model #: _____		Serial #: _____		Date of Manufacture: _____	
INSPECTION DATE	INSPECTOR	COMMENTS	PASS/FAIL	CORRECTIVE ACTION NEEDED	APPROVED BY

## 8.0 Labels

The labels must be present and legible.



### FallTech

**DO NOT REMOVE LABEL**

OSHA 1926.502

ANSI Z359.14-2021 Class 1

Date of Mfg: NOV 2022

SERIAL NUMBER: 1234567

Style#: 72706SA1

Lifeline Material: Dyneema

Working Length: 6 Ft

Max Arrest Force: 1,800 Lbs

Avg Arrest Force: 1,350 Lbs Maximum

Max Arrest Distance when anchored overhead: 42 In

Capacity, Single User: 130-310 Lbs

Inspect before each use. Remove from service if energy absorber has been deployed

### ! WARNING ! ADVERTENCIA !

USER MUST READ AND FOLLOW INSTRUCTIONS SUPPLIED WITH THIS PRODUCT AT TIME OF SHIPMENT. FAILURE TO DO SO MAY RESULT IN SERIOUS INJURY OR DEATH. INSPECT BEFORE EACH USE. SEE INSTRUCTIONS FOR INSPECTION PROCEDURES AND FOR RESTRICTIONS ON USE AND COMPATIBILITY.

VEA EL MANUAL DE INSTRUCCIONES DE ADVERTENCIAS DE USO. VOIR LE MANUEL DE GARDE D'UTILISATION.

**NON-LEADING EDGE  
MAX. USE BELOW D-RING  
5 ft.**

**!INSPECTION!** Inspect this product before each use. Annual inspection by a competent person is required. Do not use if inspection reveals unsafe or defective condition. Remove the product from service immediately if it has been subjected to fall arrest forces. See the user instruction manual for complete inspection procedures.

412-02572 Rev A

Mark/punch on grid:

- Initial in-service date

- Date of passed inspection

- Inspect before each use

- Competent person to

inspect annually.

Initials:							
Date:							

412-02573 Rev A

## 9.0 Definitions

The following are general definitions of fall protection terms as defined by ANSI Z359.0-2012.

**Anchorage** - A secure connecting point or a terminating component of a fall protection system or rescue system capable of safely supporting the impact forces applied by a fall protection system or anchorage subsystem.

**Anchorage Connector** - A component or subsystem that functions as an interface between the anchorage and a fall protection, work positioning, rope access or rescue system for the purpose of coupling the system to the anchorage.

**Arrest Distance** - The total vertical distance required to arrest a fall. The arrest distance includes the deceleration distance and activation distance.

**Authorized Person** - A person assigned by the employer to perform duties at a location where the person will be exposed to a fall hazard.

**Available Clearance** - The distance from a reference point, such as the working platform, to the nearest obstruction that an authorized person might contact during a fall which, if struck, could cause injury.

**Capacity** - The maximum weight that a component, system or subsystem is designed to hold.

**Certification** - The act of attesting in writing that the criteria established by these standards or some other designated standard have been met.

**Certified Anchorage** - An anchorage for fall arrest, positioning, restraint or rescue systems that a qualified person certifies to be capable of supporting the potential fall forces that could be encountered during a fall.

**Clearance** - The distance from a specified reference point, such as the working platform or anchorage of a fall arrest system, to the lower level that a worker might encounter during a fall.

**Clearance Requirement** - The distance below an authorized person that must remain clear of obstructions in order to ensure that the authorized person does not make contact with any objects that would cause injury in the event of a fall.

**Competent Person** - An individual designated by the employer to be responsible for the immediate supervision, implementation and monitoring of the employer's managed fall protection program who, through training and knowledge, is capable of identifying, evaluating and addressing existing and potential fall hazards, and who has the employer's authority to take prompt corrective action with regard to such hazards.

**Component** - An element or integral assembly of interconnected elements intended to perform one function in the system.

**Connecting Subsystem** - An assembly, including the necessary connectors, comprised of all components, subsystems, or both, between the anchorage or anchorage connector and the harness attachment point.

**Connector** - A component or element that is used to couple parts of the system together.

**Deceleration Distance** - The vertical distance between the user's fall arrest attachment at the onset of fall arrest forces during a fall, and after the fall arrest attachment comes to a complete stop.

**Energy (Shock) Absorber** - A component whose primary function is to dissipate energy and limit deceleration forces which the system imposes on the body during fall arrest.

**Fall Arrest** - The action or event of stopping a free fall or the instant where the downward free fall has been stopped.

**Fall Hazard** - Any location where a person is exposed to a potential free fall.

**Free Fall** - The act of falling before a fall protection system begins to apply forces to arrest the fall.

**Free Fall Distance** - The vertical distance traveled during a fall, measured from the onset of a fall from a walking working surface to the point at which the fall protection system begins to arrest the fall.

**Harness, Full Body** - A body support designed to contain the torso and distribute the fall arrest forces over at least the upper thighs, pelvis, chest and shoulders.

**Horizontal Lifeline** - A component of a horizontal lifeline subsystem, consisting of a flexible line with connectors or other coupling means at both ends for securing it horizontally between two anchorages or anchorage connectors.

**Horizontal Lifeline Subsystem** - An assembly, including the necessary connectors, comprised of a horizontal lifeline component and, optionally, of:  
a) An energy absorbing component or, b) A lifeline tensioner component, or both. This subsystem is normally attached at each end to an anchorage or anchorage connector. The end anchorages have the same elevation.

**Horizontal Lifeline** – A component of a horizontal lifeline subsystem, consisting of a flexible line with connectors or other coupling means at both ends for securing it horizontally between two anchorages or anchorage connectors.

**Horizontal Lifeline Subsystem** – An assembly, including the necessary connectors, comprised of a horizontal lifeline component and, optionally, of:  
a) An energy absorbing component or, b) A lifeline tensioner component, or both. This subsystem is normally attached at each end to an anchorage or anchorage connector. The end anchorages have the same elevation.

**Lanyard** - A component consisting of a flexible rope, wire rope or strap, which typically has a connector at each end for connecting to the body support and to a fall arrester, energy absorber, anchorage connector or anchorage.

**Lanyard Connecting Subsystem** - An assembly, including the necessary connectors, comprised of a lanyard only, or a lanyard and energy absorber.

**Personal Fall Arrest System (PFAS)** - An assembly of components and subsystems used to arrest a person in a free fall.

**Positioning** - The act of supporting the body with a positioning system for the purpose of working with hands free.

**Positioning Lanyard** - A lanyard used to transfer forces from a body support to an anchorage or anchorage connector in a positioning system.

**Qualified Person** - A person with a recognized degree or professional certificate and with extensive knowledge, training and experience in the fall protection and rescue field who is capable of designing, analyzing, evaluating and specifying fall protection and rescue systems.

**Self-Retracting Device (SRD)** - A device that contains a drum wound line that automatically locks at the onset of a fall to arrest the user, but that pays out from and automatically retracts onto the drum during normal movement of the person to whom the line is attached.

**Snaphook** - A connector comprised of a hook-shaped body with a normally closed gate or similar arrangement that may be opened to permit the hook to receive an object and, when released, automatically closes to retain the object.

**Swing Fall** - A pendulum-like motion that occurs during and/or after a vertical fall. A swing fall results when an authorized person begins a fall from a position that is located horizontally away from a fixed anchorage.

## APPENDIX A



Table 1A: Specifications for DuraTech Mini SRL-P					
Model #	Lifeline Material	Working Length and Weight	Materials and Specifications	Capacity and Standards	Images
72706SA1 72706SA3 72706SA4 72706SA5 72706SA6 72706SB1 72706SB2 72706SB3 72706SB4 72706SB5 72706SB6 72706SG5 72706SG6	Dyneema	6 ft. (1.8 m)  2.8 lbs. (1.3 kg)	Housing: Nylon  Anchorage Carabiner: 5,000 lbs (22.2 kN) with 3,600 lbs (16 kN) Gate Strength	<b>Single User Capacity:</b> 130 to 310 lbs. (59 to 141 kg)  <b>ANSI Z359.14-2021 Class 1</b>  <b>OSHA 1926.502 OSHA 1910.66</b>	
72706TB1 72706TB2 72706TB3 72706TB3F 72706TB4 72706TB5 72706TB6 72706TH0 72706TH1 72706TH3 72706TH5		6 ft. (1.8 m)  5.9 lbs. (2.7 kg)	Leg-end Connectors: 5,000 lbs (22.2 kN) with 3,600 lbs (16 kN) Gate Strength		

Table 1B: 6' DuraTech Mini Class 1 Performance							
Part #s and Conditions		Typical Performance for 130 to 310 lbs. (59-141 kg) User			ANSI Performance Requirements 130 to 310 lbs. (59-141 kg) User		
Part #	Anchorage Condition	Arrest Distance	Average Arrest Force	Maximum Arrest Force	Maximum Arrest Distance	Average Arrest Force *Conditioned	Maximum Arrest Force
All part numbers shown in Table 1A above	Overhead, Non-Leading Edge (ANSI Z359.14-2021)	19" (0.5 m)	822 lbf (3.7 kN)	1,270 lbf (5.7 kN)	42" (1.1 m)	1,575 lbf (7.0 kN)	1,800 lbf (8 kN)
	5' Below D-Ring, Non-Leading Edge (OSHA)	82" (2.1 m)	839 lbf (3.7 kN)	1,530 lbf (6.8 kN)	N/A	N/A	