

## Single Anchor Vertical Lifelines and Fall Arresters

### User Instruction Manual

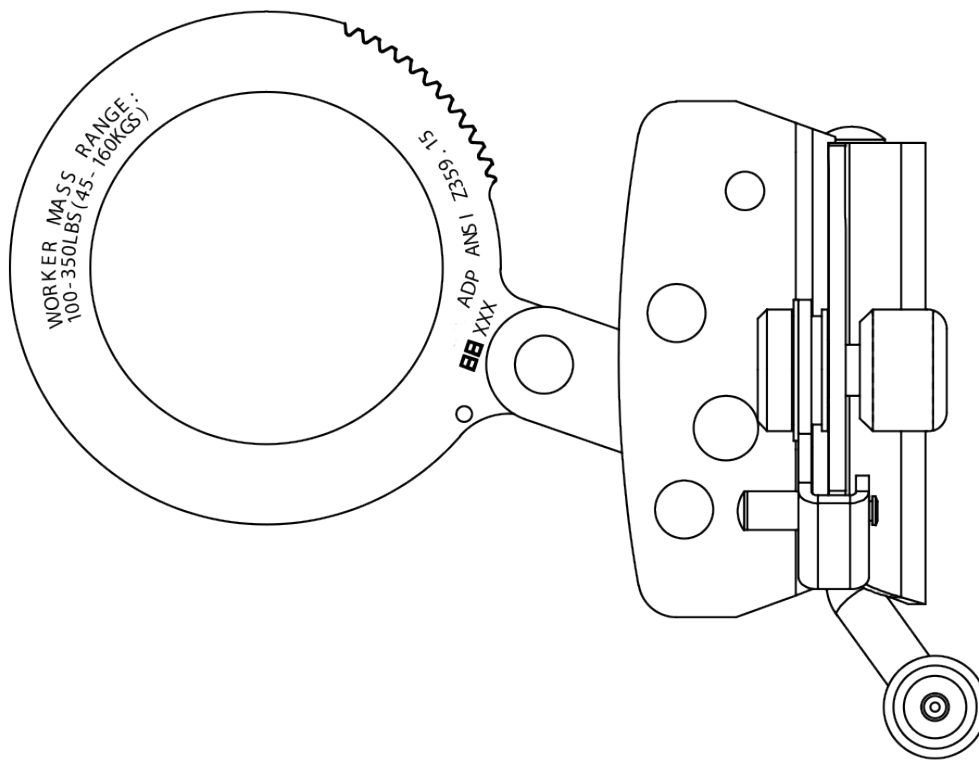

This manual is intended to meet the Manufacturer's Instructions as required by the American National Standards Institute (ANSI) Z359 and should be used as part of an employee training program as required by the Occupational Safety and Health Administration (OSHA).

## Table of Contents

1.0	Warnings and Important Information .....	3
2.0	Description .....	4
3.0	Application .....	4
4.0	System Requirements .....	5
5.0	Installation and Use .....	5
6.0	Maintenance, Service and Storage .....	12
7.0	Inspection .....	12
8.0	Labels .....	13
9.0	Definitions .....	16
	Appendix A .....	18

## 1.0 Warnings and Important Information

### **WARNING**

- Avoid moving machinery, thermal, electrical and/or chemical hazards as contact may cause serious injury or death.
- Avoid swing falls.
- Follow the weight restrictions and recommendations in this manual.
- Remove from service any equipment subjected to fall arrest forces.
- Remove from service any equipment that fails inspection.
- Do not alter or intentionally misuse this equipment.
- Consult FallTech when using this equipment in combination with components or subsystems other than those described in this manual.
- Do not connect rebar hooks, large carabiners, or large snap hooks to the FBH dorsal D-rings as this may cause a roll-out condition and/or unintentional disengagement.
- Avoid sharp and/or abrasive surfaces and edges.
- Use caution when performing arc welding. Arc flash from arc welding operations, including accidental arcs from electrical equipment, can damage equipment and are potentially fatal.
- Examine the work area. Be aware of the surroundings and workplace hazards that may impact safety, security, and the functioning of fall arrest systems and components.
- Hazards may include but not be limited to cable or debris tripping hazards, equipment failures, personnel mistakes, moving equipment such as carts, barrows, fork lifts, cranes, or dollies. Do not allow materials, tools or equipment in transit to contact any part of the fall arrest system.
- Do not work under suspended loads.

### **IMPORTANT**

This product is part of a personal fall arrest, restraint, work positioning, suspension, or rescue system. A Personal Fall Arrest System (PFAS) is typically composed of an anchorage and a Full Body Harness (FBH), with a connecting device, i.e., a Shock Absorbing Lanyard (SAL), or a Self-Retracting Device (SRD), attached to the dorsal D-ring of the FBH.

These instructions must be provided to the worker using this equipment. The worker must read and understand the manufacturer's instructions for each component or part of the complete system. Manufacturer's instructions must be followed for proper use, care, and maintenance of this product. These instructions must be retained and be kept available for the worker's reference at all times. Alterations or misuse of this product, or failure to follow instructions, may result in serious injury or death.

A Fall Protection Plan must be on file and available for review by all workers. It is the responsibility of the worker and the purchaser of this equipment to assure that users of this equipment are properly trained in its use, maintenance, and storage. Training must be repeated at regular intervals. Training must not subject the trainee to fall hazards.

Consult a doctor if there is reason to doubt your fitness to safely absorb the shock of a fall event. Age and fitness seriously affect a worker's ability to withstand falls. Pregnant women or minors must not use this equipment.

ANSI limits the weight of fall protection equipment users to a maximum of 310 lbs. Products in this manual may have a rated capacity exceeding ANSI capacity limits. Heavy users experience more risk of serious injury or death due to falls because of increased fall arrest forces placed on the user's body. In addition, the onset of suspension trauma after a fall even may be accelerated for heavy users.

The user of the equipment discussed in this manual must read and understand the entire manual before beginning work.

NOTE: For more information consult the ANSI Z359 body of standards.

## 2.0 Description

The FallTech® Single Anchor Vertical Lifelines (VLL) are typically composed of a rope of various materials, lengths and end terminations. When a VLL is combined with connectors, a Shock Absorbing Lanyard (SAL), a Fall Arrester (Rope Grab), and a counterweight, it becomes a Fall Arrester Connector Subsystem (FACSS). See Figure 1.

A FACSS, combined with an anchorage and a Full Body Harness (FBH), form a Personal Fall Arrest System (PFAS). A PFAS is an assembly of components and subsystems used to arrest a person during a fall event. See Figure 2.

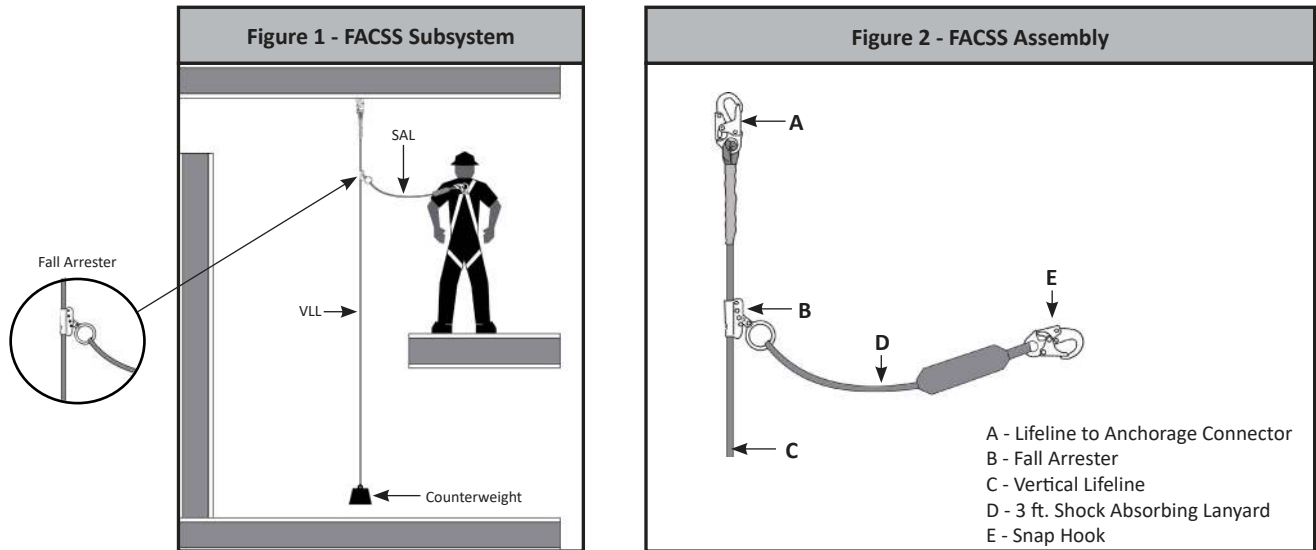

For the purposes of this manual, the system may be referred to as the equipment, Fall Arrester (Rope Grab), Fall Arrester Connector Subsystem (FACSS), the unit or the device. See Table 1 in Appendix A for ANSI/OSHA compliance information.

**2.1 Vertical Lifelines (VLL):** VLLs are the vertical rope lifeline portion of a fall arrest or restraint system. VLLs are available in many configurations, lengths and materials. All FallTech VLLs are  $\frac{5}{8}$ " diameter synthetic rope. VLLs are designated as Types, depending on construction, material and end configuration. When so equipped, VLL anchorage snap hooks are pre-installed in plated steel thimbles.

**2.2 Fall Arrester and Fall Arrester Lanyard Sets:** Fall Arresters are steel mechanisms designed to allow worker mobility along the lifeline as the worker moves about. A spring-loaded internal cam locks onto the VLL during a fall event, arresting the fall. Some fall arresters are sold separately. Fall Arrester Lanyard Sets are composed of a Fall Arrester attached to a SAL, which is permanently attached to a snap hook, configured to connect to a FBH. See Table 1 in Appendix A.

## 3.0 Application

**3.1 Purpose:** The systems and equipment discussed in this manual are intended for use as part of a PFAS or restraint system.

**3.2 Personal Fall Arrest System:** A VLL, combined with a fall arrester (rope grab), and a SAL, forms a Fall Arrester Connector Subsystem (FACSS). The FACSS, combined with an anchorage and an FBH, forms a PFAS, used to arrest the user during a fall event. Maximum permissible free fall is six feet. A PFAS is an assembly of components and subsystems used to arrest a person in a free fall. A PFAS is typically composed of an anchorage and an FBH, with a connecting device, i.e., a SAL, an SRD, or a FACSS attached to the dorsal D-ring of the FBH. PFAS components used with this equipment must meet applicable ANSI Z359 requirements and OSHA regulations. OSHA requires a personal fall arrest system be able to arrest the user's fall with a maximum arresting force of 1,800 lbs., and limit the free fall to 6 feet or less. If the maximum free fall distance must be exceeded, the employer must document, based on test data, that the maximum arresting force will not be exceeded, and the personal fall arrest system will function properly.

**3.3 Fall Restraint:** The VLL, when used with a non-trailing (manual) fall arrester and designed and installed by a Competent Person, may be configured as a restraint system used in fall restraint, to prevent the user from reaching a fall hazard. No free fall is permitted and must meet OSHA regulations and ANSI standards.

**3.4 Rescue, Positioning, Riding or Climbing:** The VLL is not suited for rescue, positioning, riding or climbing applications. See ANSI Z359.4-2013.

**3.5 Application Limits:** Take action to avoid sharp edges, abrasive surfaces, and thermal, electrical and chemical hazards.

**DO NOT:** Use the system system described in this manual if the user is working on an unstable surface, such as sand.

## 4.0 System Requirements

**4.1 Capacity:** The fall arresters, connectors, VLLs, and SALs covered in this manual, are ANSI and OSHA compliant, with a listed single user capacity, including clothing, tools, etc., of 130 lbs (59 kg) to no more than 310 lbs., (140.6 kg), No more than one VLL may be connected to one anchorage/anchorage connector at one time.

**4.2 Compatibility of Connectors:** Connectors are considered to be compatible with connecting elements when they have been designed to work together in such a way that their sizes and shapes do not cause their gate mechanisms to inadvertently open regardless of how they become oriented. Contact FallTech if you have any questions about compatibility. Connectors must be compatible with the anchorage or other system components. Do not use equipment that is not compatible. Non-compatible connectors may unintentionally disengage. Connectors must be compatible in size, shape, and strength. Self-closing, self-locking snap hooks and carabiners are specified by OSHA and ANSI.

**4.3 Compatibility of Components:** Equipment is designed for use with approved components and subsystems only. Substitutions or replacements made with non-approved components or subsystems may jeopardize compatibility of equipment and may affect the safety and reliability of the complete system.

**4.4 Making Connections:** Only use self-locking snap hooks and carabiners with this equipment. Only use connectors that are suitable to each application. Ensure all connections are compatible in size, shape and strength. Do not use equipment that is not compatible. Visually ensure all connectors are fully closed and locked. Connectors (snap hooks and carabiners) are designed to be used only as specified in this manual. See Figure 3.

### DO NOT:

- a) Attach multiple snap hooks or carabiners to an anchorage.
- b) Attach snap hooks or carabiners in a manner that may result in the gate being loaded.
- c) Allow a false engagement, where features that protrude from the snap hook or carabiner catch on the anchor.
- d) Attach snap hooks or carabiners to each other.
- e) Attach snap hooks or carabiners to webbing or rope lanyard or tie-back (unless the manufacturer's instructions for both the lanyard and connector specifically allows such a connection).
- f) Attach snap hooks or carabiners to any object which is shaped or dimensioned such that the snap hook or carabiner will not close and lock, or that roll-out could occur.

**4.5 PFAS Anchorage Strength:** An anchorage selected for PFAS must have a strength able to sustain a static load applied in the direction permitted by the PFAS of at least:

- a) Two times the maximum arrest force permitted when certification exists, or
- b) 5,000 lbs. (22.2 kN) in the absence of certification.

**4.6 Restraint Anchorage Strength:** Anchorages selected for restraint, and travel restraint systems, shall have a strength able to sustain static loads applied in the directions permitted by the system of at least:

- a) 3,000 lbs. (13.3 kN) for non-certified anchorages, or
- b) two times the foreseeable force for certified anchorages.

**4.7 Rescue:** Rescue applications require specialized equipment and is beyond the scope of this manual. See ANSI Z359.4-2014.

## 5.0 Installation and Use

**DO NOT** use any FACSS discussed in this manual until the system has been completely installed, inspected, and approved for use by a Competent Person.

**5.1 Anchorage Location:** Select a suitable anchorage point that will support the strength requirement and minimize free fall and swing hazards. Do not work above the anchorage point.

**5.2 Fall Clearance Distance:** When working at heights and using a PFAS, it is important to consider the distance between the walking/working level and the next lower level, or obstruction, to ensure there is sufficient room for the PFAS to arrest a fall. Fall Clearance Distance is the distance that is required to safely arrest the fall of a user. The Distance may be calculated by adding together the Length of the Lanyard, the Deceleration Distance, the Height of the Worker, plus a Safety Factor of 1½ ft.

Synthetic rope is subject to elongation, or stretch. As the distance between the anchorage and the grab increases, the portion of the rope that is subjected to loads increases, thereby increasing the effects of elongation. Elongation can be as much as 10% for rope in wet conditions or when loaded to 900 lbs.. Consideration of elongation must be considered when estimating fall clearance distances. See Figure 3.

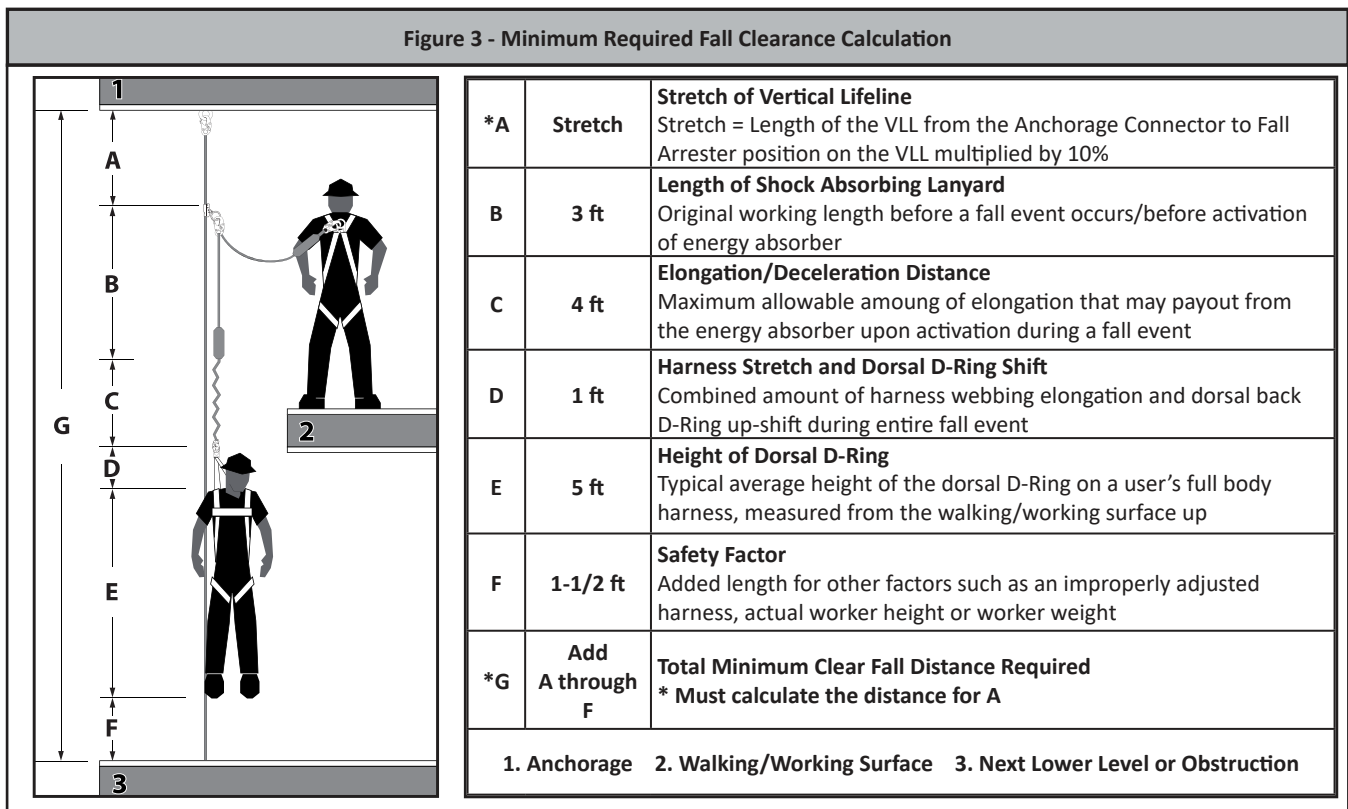

**5.3 Swing Fall:** Swing falls occur when the anchorage point is not directly above the point where a fall occurs. The force of striking an object in a swing fall may cause serious injury. In a swing fall, the total vertical fall distance will be greater than if the user had fallen directly below the anchorage point, thus increasing the total free fall distance and the area required to safely arrest the user. Minimize swing falls by working as directly below the anchorage point as possible. Move the anchorage as required. Never permit a swing fall if injury could occur. If a swing fall situation exists in your application consult a Competent Person before proceeding. See Figure 4.

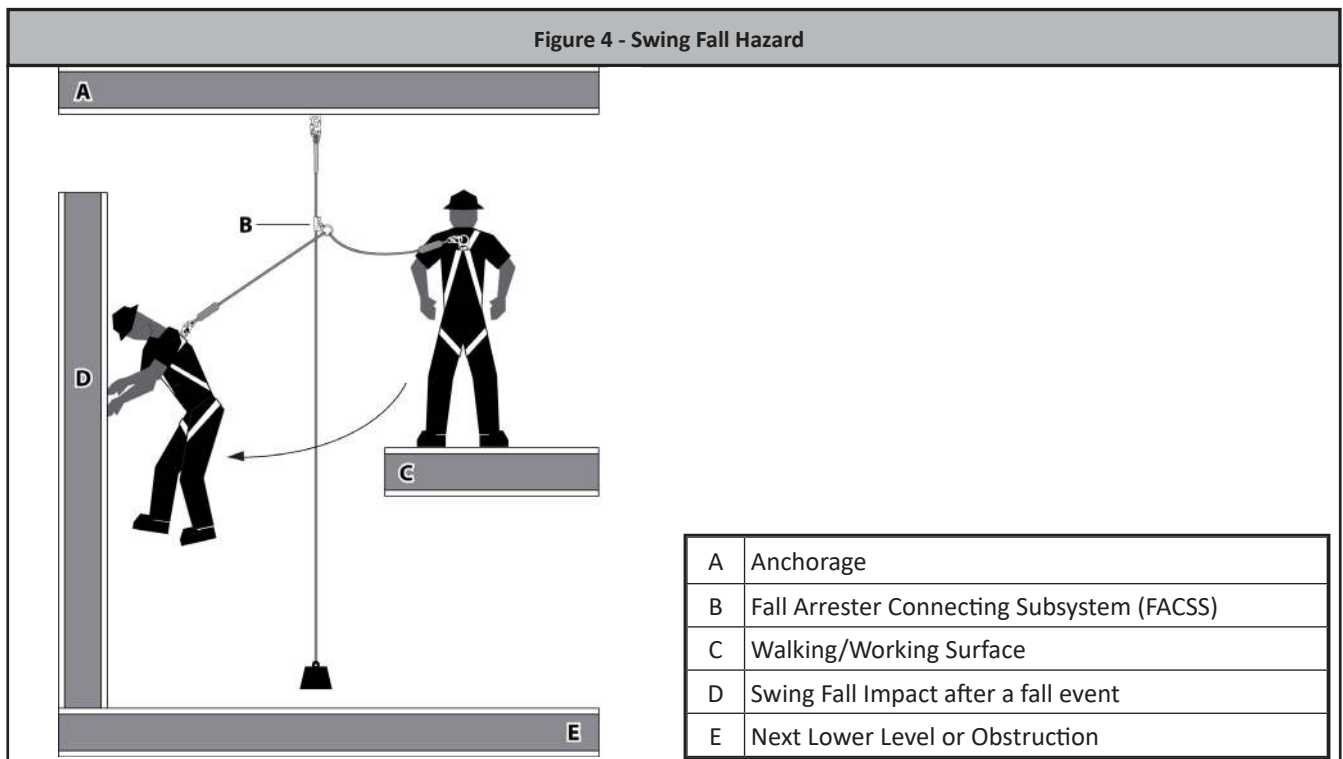

**5.4 Installation and Use of VLL, Fall Arrester and Fall Arrester Lanyard Set:** This manual assumes the anchorage and the FBH is in compliance and has been previously installed and inspected by a Competent Person. VLLs, Fall Arresters and Fall Arrester Lanyard Sets are components in a FACSS, but installation and use will be discussed separately.

All VLLs are similar, but materials and end terminations will vary. The basic function is to provide a length of lifeline for the Fall Arrester to travel on and grip the rope to arrest fall events. For best performance, tension in the lifeline allows the Fall Arrester to be positioned with greater ease. Adding a weight to the to the bottom is described in the following sections. When it is not possible to add weight to maintain a taut line, the lower end shall have rope stop to prevent the fall arrester from inadvertently traveling off the end of the lifeline.

Do not manipulate or hold the Fall Arrester body or lever, use the connected lanyard to move the Fall Arrester to the desired location.

**5.4.1 VLL Type A – F:** All VLLs have a self-closing and self-locking snap hook pre-installed in a thimble eye at the anchorage end, with one exception, the Type F, which is without a snap hook and is configured for a carabiner. Attach the self-closing self-locking snap hook or carabiner to the anchorage. Attach a minimum five-pound counterweight to the non-anchorage end to maintain a taut line, see Figure 5. Let the non-anchorage end hang freely. If the rope passes over an edge of any kind, or any type of rough or uneven surface, provide abrasion protection. See Figure 6.

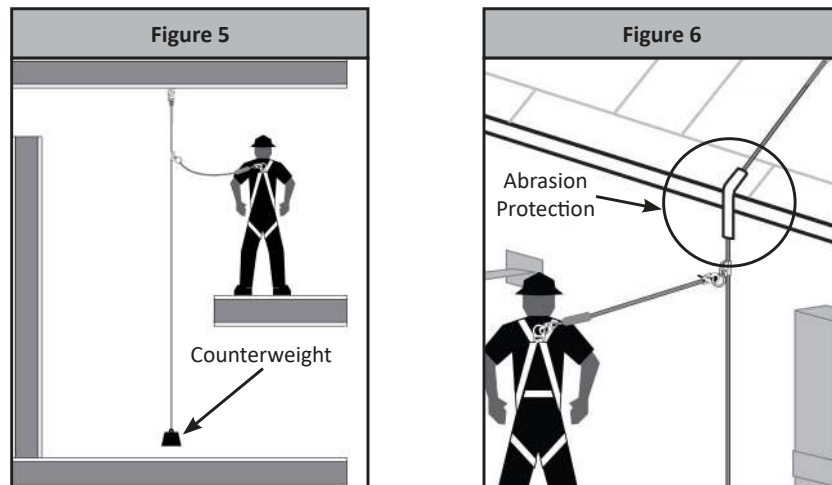

**NOTE:** The Fall Arrester discussed herein have an UP arrow stamped in a prominent location. When installing a grab onto a VLL, visually ensure the UP arrow is pointed at the anchor end of the VLL. The grab must be right-side up to fully close. This Fall Arrester employs an anti-inversion cam to prevent closure if installed upside down.

**⚠ WARNING**

**The Fall Arrester must be installed with the arrow pointing upward. If the grab is installed upside down, it WILL NOT LOCK during a fall event, which could result in serious injury or death.**

**5.4.2 ANSI Compliant FACSS Installation (Part Numbers 7489 and 8388):**

**Step 1:** Attach the VLL to the anchor per Section 5.4.1.

**Step 2:** To open the hinged arrester, hold it in your left hand. Rotate the safety latch all the way up. See Figure 7.

**Step 3:** Unscrew the knurled locking knob. See Figure 8. Open the hinged gate. See Figure 9.

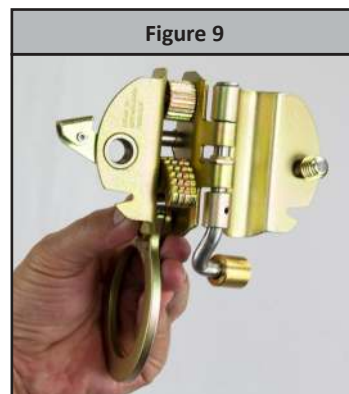
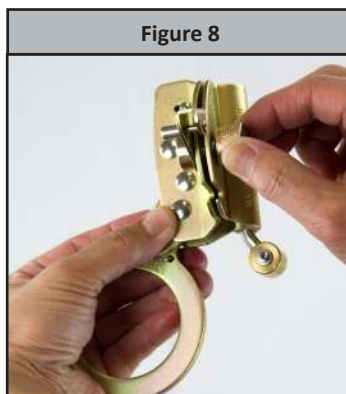
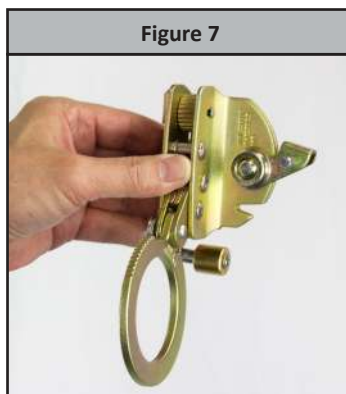

**Step 4:** Lift the ring to retract the cam assembly. See Figure 10. Place the VLL in the rope channel. See Figure 11.

**Step 5:** Close the gate. The arrester utilizes an anti-inversion cam in the hinge to prevent the grab from closing if incorrectly oriented. The arrow must point up to close.

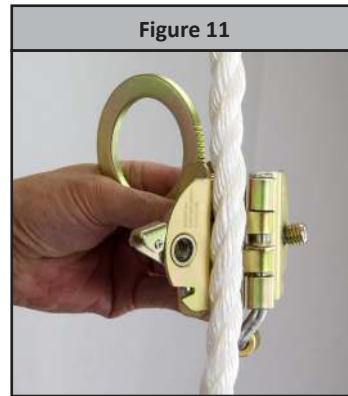
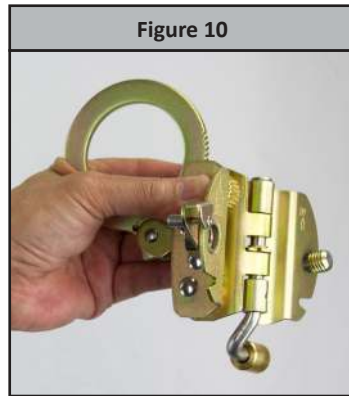

**Step 6:** Screw the lock knob back in until tight. See Figure 12. Rotate the safety latch all the way down. See Figure 13.

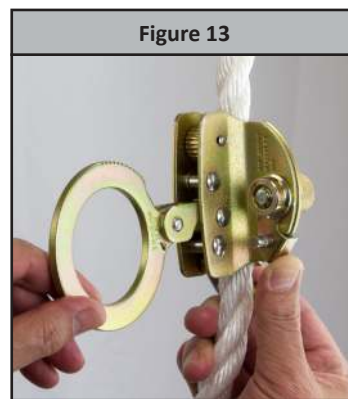
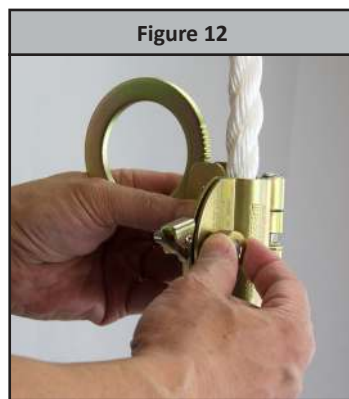

**Step 7:** Connect the SAL to the Arrester (if applicable).

**Step 8:** Connect the SAL shock-absorbing end to the FBH dorsal or sternal D-ring.

#### 5.4.3 OSHA Only FACSS Installation (Part Number 7479 and 8358):

**Step 1:** Ensure the "Up" arrow is pointed up, toward the PFAS anchorage, see the arrow on the arrester on Figure 14.

**Step 2:** To open the Fall Arrester, depress the safety latch and unscrew the knurled locking knob, see Figure 15.



- Step 3:** Lift the ring assembly to retract the cam, see Figure 16.
- Step 4:** Place the VLL in the channel, opposite the cam, see Figure 17.



- Step 5:** Depress the safety latch and tighten the knurled locking knob, see Figure 18.
- Step 6:** Connect the shock-absorbing end of the lanyard to the FBH. Connect the non-shock absorbing end of the lanyard to the large ring of the grab.

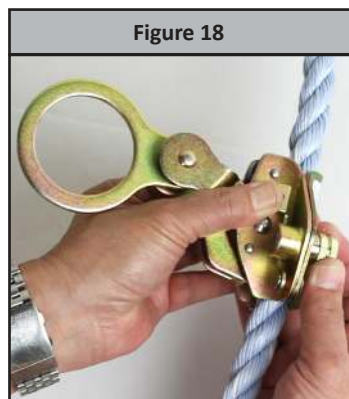

**Step 7:** Pull down on the ring and cam lever to ensure the Fall Arrester locks onto the VLL. These Fall Arresters are the trailing type. If a fall event occurs, the Fall Arrester will lock onto the VLL and arrest the fall.

**5.4.4 OSHA Only FACSS Installation (Part Number 7491 and 8359):**

Refer to section 5.4.2 for installation, the installation of this Fall Arrester is the same as Part Number 7489.

**5.4.5 OSHA Only FACSS Installation (Part Number 8355):**

- Step 1:** Ensure the “Up” arrow is pointed up, toward the PFAS anchorage, see the arrow on the arrester on Figure 19.
- Step 2:** To open the hinged Fall Arrester, hold it in your left hand and raise the safety latch, see Figure 20.

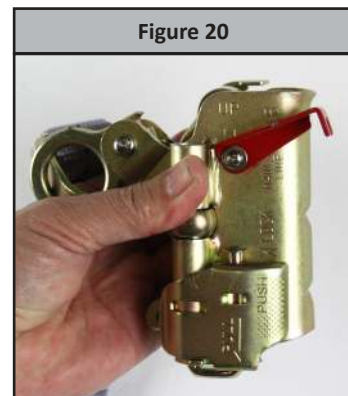
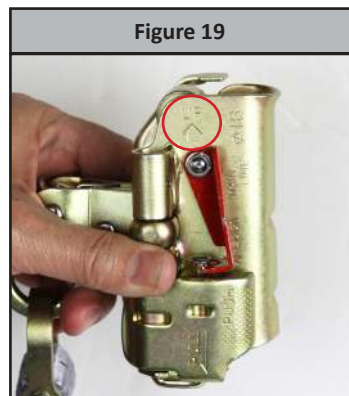

- Step 3:** Hold the cam lever up with your left hand, and push in and down on the Locking Bolt Actuator with your thumb, see Figure 21. Allow it to rotate back slightly.
- Step 4:** Push the Locking Bolt Actuator down to lower the actuator pin, open the hinged gate, see Figure 22.

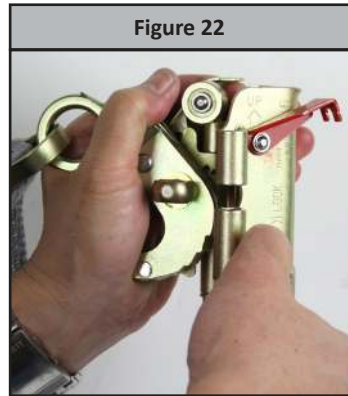
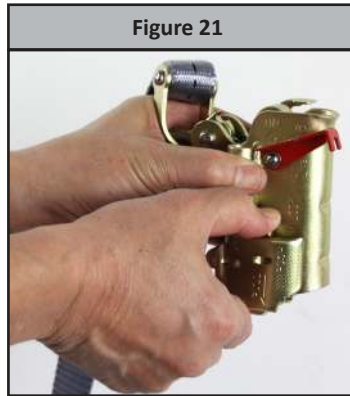

- Step 5:** Place the VLL in the rope channel, see Figure 23. Close the hinge and push in and down on the Locking Bolt Actuator with your thumb. Push the Locking Bolt Actuator down to lower the actuator pin. Allow the locking bolt to engage the lock receiver. Lower the safety latch, see Figure 24.



- Step 6:** The 8355 Fall Arrester is permanently connected to a SAL equipped with a self-closing and self-locking snap hook. Attach the snap hook to the dorsal D-ring of the FBH.

**5.4.6 OSHA Only FACSS Installation (Part Number 8368):**

- Step 1:** Ensure the “Up” arrow is pointed up, toward the PFAS anchorage, see the arrow on the arrester, see Figure 25.
- Step 2:** The Fall Arrester is not hinged and if not factory pre-installed on a VLL, requires a Type C VLL with a taped end termination. Hold the rope channel and lift up on the ring and cam lever arm to open the cam, see Figure 26.

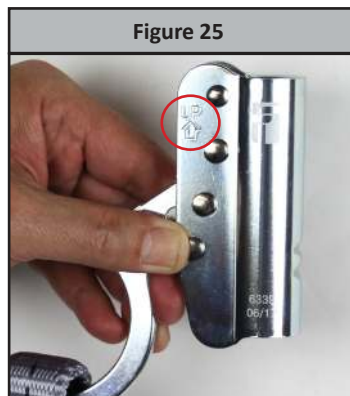

**Step 3:** Insert the taped end of the VLL into the channel from the top. Ensure the UP arrow is pointed up to the anchor. Release the ring and cam lever, Figure 27.

**Step 4:** The Fall Arrester is permanently attached to a SAL equipped with a snap hook. Attach the snap hook to the dorsal D-ring on the FBH. Slide the grab up the VLL to the work location. At the work location, release the cam lever.



**Step 5:** The 8368 Fall Arrester is a trailing type. If a fall event occurs, the Fall Arrester will lock onto the VLL and arrest the fall.

#### 5.4.7 OSHA Only FACSS Installation (Part Number 8353 and 8353LT):

**Step 1:** Ensure the “Up” arrow is pointed up, toward the PFAS anchorage, see the arrow on the arrester, see Figure 28.

**Step 2:** The Fall Arrester is not hinged and if not factory pre-installed on a VLL, requires a Type C or Type D VLL with a taped end termination. Hold the rope channel and lift up on the ring and cam lever arm to open the cam, see Figure 29.

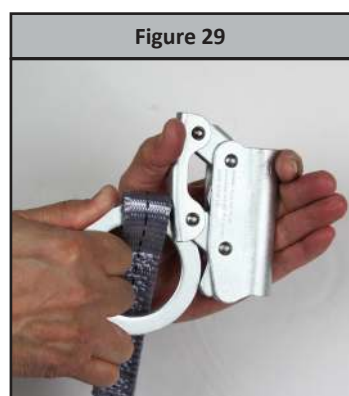
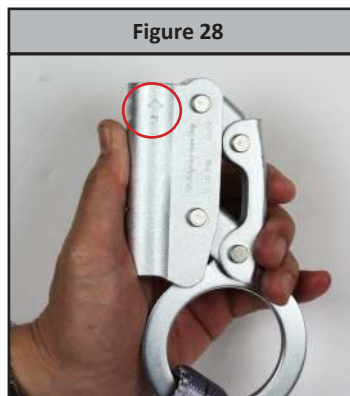

**Step 3:** Insert the taped end of the lifeline into the channel from the top, see Figure 30. Continue to hold the cam open and slide the grab up the VLL to the work location.

**Step 4:** The Fall Arrester is permanently attached to a SAL equipped with a snap hook. Attach the snap hook to the dorsal D-ring on the FBH.

**Step 5:** To move the Fall Arrester up or down, lift the ring and cam lever, see Figure 31. At the work location, let the spring loaded ring and cam lever return to position. The grab will lock onto the VLL, and must be manually opened to move up or down the VLL. In a fall event, the Fall Arrester will arrest the fall by locking onto the VLL.

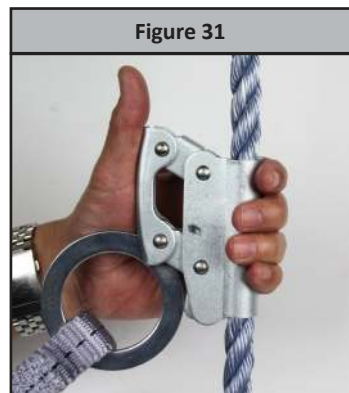
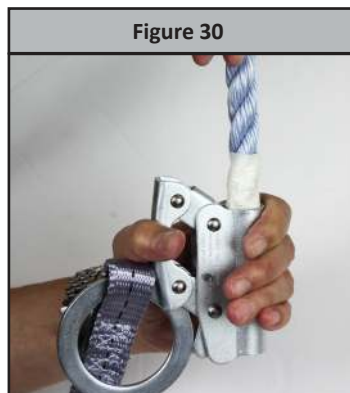

## 6.0 Maintenance, Service and Storage

**6.1 Cleaning:** Keep the arresters, lanyards, and VLLs free of dirt and debris. If necessary, clean with a water/detergent solution. Blow out with compressed air. Dry with a clean dry cloth. Do not use solvents or other caustic chemicals that could damage the system components.

**6.2 User Equipment:** Maintain, service, and store equipment in a clean, dry environment, out of direct sunlight. Do not expose the equipment to caustic vapors, chemicals, or corrosives.

**6.3 Storage:** Store in a clean, dry area. Avoid direct sunlight and contact with heat sources. Avoid exposure to environmental elements. Do not place other gear or objects on top of the equipment.

**6.4 Remove From Service:** Remove the equipment from service if it has been subjected to fall arrest forces or fails inspection. Do not attempt to repair the arrester.

## 7.0 Inspection

**7.1. Pre-Use Inspection:** Before each use, the VLL system should be inspected by the user for damage, wear and to ensure the fall arrester works properly on the rope. Please review the inspection checklist for inspection requirements.

**7.2. Inspection Frequency:** Other than pre-use inspection the FallTech VLL system should be inspected by a Competent Person at least once a year other than the user of the system.

**7.3. Inspection Checklist:** A general inspection should be done at the intervals specified in this manual. Inspect as follows:

**Step 1:** Inspect labels. Ensure legibility of content. If labels are missing or illegible, remove the system from service.

**Step 2:** Inspect all metal components for cracks, corrosion, deformities, missing parts or noticeable defects. Metal components include, snap hooks or carabiners, thimble eyes, fall arresters, D-rings, ferrules, etc....

**Step 3:** Inspect rope for wear, paying particular attention to the areas of rope most likely in contact with the fall arrester teeth. The rope should not present frayed strands, cuts, abrasions, burn marks, and discoloration indicating UV damage.\* Thimble eyes should be firmly in place, and there should be no build-up of foreign matter such as paint, dirt, rust, concrete or cement, etc...

\*Minor fuzziness of rope is acceptable so long as the inner core of the rope is not damaged.

If the FACSS has been subjected to a fall arrest load, it must be removed from service until it is inspected by a Qualified Person who either replaces or repairs and re-certifies the components for use again.

Record inspection results on the Inspection Log.

INSPECTION RECORD <i>PLANILLA de INSPECCIÓN</i>					
Model # <i>Modelo N°</i> : _____			Serial # <i>N° de serie</i> : _____		
Date of Manufacture <i>Fecha de fabricación</i> : _____					
Inspection Date <i>Fecha de inspección</i>	Inspector <i>Inspector</i>	Comments <i>Observaciones</i>	Pass/Fail <i>Pasó/No pasó</i>	Corrective Action Needed <i>Accion correctiva a realizar</i>	Approved By <i>Aprobado por</i>



Fall Arrester Lanyard Set (FALS) Labels

**FallTech** Style# (estilo): 8388  
 Size (tamaño): 3 ft  
 Date of Mfg (fecha de mfg):  
**AUG 2018**  
 Capacity (capacidad): 130 to 310 lbs  
 Material: Polyester Web  
 For use with: 5/8" Polyester Rope

**DO NOT REMOVE LABEL**  
 OSHA 1926.502  
 ANSI Z359.15-2014

Max Deployment: 4ft  
 Avg Arrest Force: 900lbs  
 Max Freefall: 6ft

SERIAL NUMBER: 234588  
 412-01400 Rev A

**Warning: Max User Weight 130-310 lbs.**  
**6ft. 900lbs.**  
 Maximum Free Fall      Average Arresting Force  
 Forces may increase when cold and/or wet  
**Read Instructions Before Use**

**INSPECTION!** Inspect this product before each use. Semi-annual inspection by a competent person is required. Do not use if inspection reveals unsafe or defective condition. Remove the product from service immediately if it has been subjected to fall arrest forces. See the user instruction manual for complete inspection procedures.

412-00409 Rev A

**!WARNING!**  
 USER MUST READ AND FOLLOW INSTRUCTIONS SUPPLIED WITH THIS PRODUCT AT TIME OF SHIPMENT. FAILURE TO DO SO MAY RESULT IN SERIOUS INJURY OR DEATH. AVOID CONTACT WITH SHARP EDGES AND ABRASIVE SURFACES. MAKE ONLY COMPATIBLE CONNECTIONS. SEE INSTRUCTIONS FOR RESTRICTIONS ON USE WITH PROPER SIZE AND TYPE OF SINGLE ANCHOR LIFELINE WITH WHICH THE FALL ARRESTER IS DESIGNED TO BE USED. SEE INSTRUCTIONS FOR INSPECTION PROCEDURES.  
 VEA EL MANUAL DE INSTRUCCIONES DE ADVERTENCIAS DE USO

1) USER MUST INSPECT BEFORE EACH USE  
 2) COMPETENT PERSON TO INSPECT AT LEAST ONCE EVERY (6) MONTHS  
 MARK OR PUNCH ON DATE GRID  
 A) INITIAL IN-SERVICE DATE  
 B) DATE OF PASSED INSPECTION  
 IF UNIT FAILS INSPECTION REMOVE FROM SERVICE

Initials:									
Date:									

412-00410 Rev A

Vertical Lifeline (VLL) Labels

**FallTech** 5/8" Vertical Lifeline  
 Style (estilo)#: 8150  
 Size (tamaño): 50' (15.2m)  
 Date of Mfg: MAR 2018

**DO NOT REMOVE LABEL**  
 OSHA 1926.502  
 ANSI Z359.15-2014  
 Capacity (capacidad): 130-310lbs  
 Material: Polyester Rope

VEA EL MANUAL DE INSTRUCCIONES DE ADVERTENCIAS DE USO.

Serial #: 4394340      412-02603 Rev A

To maintain Z359.15 compliance, only the following Fall Arresters / Fall Arrester Connecting Sub-systems (FACSS) are allowed to be used with this Vertical Lifeline:

7489: Trailing / Hinged Fall Arrester  
 8388: 3' SAL w/ Fall Arrester

412-02628 Rev A

**INSPECTION!** Inspect the lifeline before each use. Avoid contact with sharp edges or abrasive surfaces. Semi-annual inspection by a competent person is recommended. Do not use if inspection reveals unsafe or defective condition. Remove the lifeline from service immediately if it has been subjected to fall arrest forces. See the user instruction manual for complete inspection procedures.

412-02629 Rev A

1) USER MUST INSPECT BEFORE EACH USE  
 2) COMPETENT PERSON TO INSPECT AT LEAST ONCE EVERY (6) MONTHS  
 MARK OR PUNCH ON DATE GRID  
 A) INITIAL IN-SERVICE DATE  
 B) DATE OF PASSED INSPECTION  
 IF UNIT FAILS INSPECTION REMOVE FROM SERVICE

Initials:									
Date:									

412-00270 Rev A

Fall Arrester Labels (OSHA Only)

**FALLTECH** 800-719-4619

**WARNING DO NOT REMOVE LABEL**

**ROPE GRAB** FT99ALX Rev B

Read and follow manufacturer's instructions before use. Contact the manufacturer if instructions, labels or warnings are missing. Failure to comply could result in serious injury or death. Use only with 5/8" POLYESTER rope.

Mfg: \_\_\_\_\_ Model# \_\_\_\_\_

Fall Arrester Lanyard Set (FALS) Labels (OSHA Only)

**FallTech** Style# (estilo): 8358  
 Size (tamaño): 3 Ft  
 Date of Mfg (fecha de mfg):  
 AUG 2018  
 Capacity (capacidad): 130 to 310 lbs  
 Material: Polyester Web  
 Anchor end hook(s) must be attached to  
 harness lanyard keeper when not in use.  
 VEA EL MANUAL DE INSTRUCCIONES  
 DE ADVERTENCIAS DE USO

**DO NOT REMOVE LABEL**  
 OSHA 1926.502

Max Elongation: 48 in  
 SERIAL NUMBER: 1234569

**INSPECTION:** Inspect this product before each use. Semi-annual inspection by a competent person is required. Do not use if inspection reveals unsafe or defective condition. Remove the product from service immediately if it has been subjected to fall arrest forces. See the user instruction manual for complete inspection procedures.

412-00409 Rev A

Mark/punch on grid:  
 - Initial in-service date  
 - Date of passed inspection.  
 - Inspect before each use  
 - Competent person to inspect every six months

Date:	Initials:							

412-00410 Rev A

**! WARNING !**  
 USER MUST READ AND FOLLOW INSTRUCTIONS SUPPLIED WITH THIS PRODUCT AT TIME OF SHIPMENT. FAILURE TO DO SO MAY RESULT IN SERIOUS INJURY OR DEATH.  
 AVOID CONTACT WITH SHARP EDGES AND ABRASIVE SURFACES.  
 MAKE ONLY COMPATIBLE CONNECTIONS. SEE INSTRUCTIONS FOR RESTRICTIONS ON USE WITH COMPONENTS, SUBSYSTEMS, OR SYSTEMS WITH WHICH THIS ENERGY ABSORBING LANYARD IS DESIGNED TO BE USED. SEE INSTRUCTIONS FOR INSPECTION PROCEDURES.

## 9.0 Definitions

The following are general definitions of fall protection terms as defined by ANSI Z359.0-2012.

**Anchorage** - A secure connecting point or a terminating component of a fall protection system or rescue system capable of safely supporting the impact forces applied by a fall protection system or anchorage subsystem.

**Anchorage Connector** - A component or subsystem that functions as an interface between the anchorage and a fall protection, work positioning, rope access or rescue system for the purpose of coupling the system to the anchorage.

**Arrest Distance** - The total vertical distance required to arrest a fall. The arrest distance includes the deceleration distance and activation distance.

**Authorized Person** - A person assigned by the employer to perform duties at a location where the person will be exposed to a fall hazard.

**Available Clearance** - The distance from a reference point, such as the working platform, to the nearest obstruction that an authorized person might contact during a fall which, if struck, could cause injury.

**Capacity** - The maximum weight that a component, system or subsystem is designed to hold.

**Certification** - The act of attesting in writing that the criteria established by these standards or some other designated standard have been met.

**Certified Anchorage** - An anchorage for fall arrest, positioning, restraint or rescue systems that a qualified person certifies to be capable of supporting the potential fall forces that could be encountered during a fall.

**Clearance** - The distance from a specified reference point, such as the working platform or anchorage of a fall arrest system, to the lower level that a worker might encounter during a fall.

**Clearance Requirement** - The distance below an authorized person that must remain clear of obstructions in order to ensure that the authorized person does not make contact with any objects that would cause injury in the event of a fall.

**Competent Person** - An individual designated by the employer to be responsible for the immediate supervision, implementation and monitoring of the employer's managed fall protection program who, through training and knowledge, is capable of identifying, evaluating and addressing existing and potential fall hazards, and who has the employer's authority to take prompt corrective action with regard to such hazards.

**Component** - An element or integral assembly of interconnected elements intended to perform one function in the system.

**Connecting Subsystem** - An assembly, including the necessary connectors, comprised of all components, subsystems, or both, between the anchorage or anchorage connector and the harness attachment point.

**Connector** - A component or element that is used to couple parts of the system together.

**Deceleration Distance** - The vertical distance between the user's fall arrest attachment at the onset of fall arrest forces during a fall, and after the fall arrest attachment comes to a complete stop.

**Energy (Shock) Absorber** - A component whose primary function is to dissipate energy and limit deceleration forces which the system imposes on the body during fall arrest.

**Fall Arrest** - The action or event of stopping a free fall or the instant where the downward free fall has been stopped.

**Fall Hazard** - Any location where a person is exposed to a potential free fall.

**Free Fall** - The act of falling before a fall protection system begins to apply forces to arrest the fall.

**Free Fall Distance** - The vertical distance traveled during a fall, measured from the onset of a fall from a walking working surface to the point at which the fall protection system begins to arrest the fall.

**Harness, Full Body** - A body support designed to contain the torso and distribute the fall arrest forces over at least the upper thighs, pelvis, chest and shoulders.

**Horizontal Lifeline** - A component of a horizontal lifeline subsystem, consisting of a flexible line with connectors or other coupling means at both ends for securing it horizontally between two anchorages or anchorage connectors.

**Horizontal Lifeline Subsystem** - An assembly, including the necessary connectors, comprised of a horizontal lifeline component and, optionally, of:  
a) An energy absorbing component or, b) A lifeline tensioner component, or both. This subsystem is normally attached at each end to an anchorage or anchorage connector. The end anchorages have the same elevation.

**Lanyard** - A component consisting of a flexible rope, wire rope or strap, which typically has a connector at each end for connecting to the body support and to a fall arrester, energy absorber, anchorage connector or anchorage.

**Lanyard Connecting Subsystem** - An assembly, including the necessary connectors, comprised of a lanyard only, or a lanyard and energy absorber.

**Personal Fall Arrest System (PFAS)** - An assembly of components and subsystems used to arrest a person in a free fall.

**Positioning** - The act of supporting the body with a positioning system for the purpose of working with hands free.

**Positioning Lanyard** - A lanyard used to transfer forces from a body support to an anchorage or anchorage connector in a positioning system.

**Qualified Person** - A person with a recognized degree or professional certificate and with extensive knowledge, training and experience in the fall protection and rescue field who is capable of designing, analyzing, evaluating and specifying fall protection and rescue systems.







**Rescuer** - Person or persons other than the rescue subject acting to perform an assisted rescue by operation of a rescue system.

**Self-Retracting Device (SRD)** - A device that contains a drum wound line that automatically locks at the onset of a fall to arrest the user, but that pays out from and automatically retracts onto the drum during normal movement of the person to whom the line is attached.

**Snaphook** - A connector comprised of a hook-shaped body with a normally closed gate or similar arrangement that may be opened to permit the hook to receive an object and, when released, automatically closes to retain the object.

**Swing Fall** - A pendulum-like motion that occurs during and/or after a vertical fall. A swing fall results when an authorized person begins a fall from a position that is located horizontally away from a fixed anchorage.







## APPENDIX A

Table 1: ANSI Compliant Vertical Lifelines and Fall Arresters					
Designation Type and Part #	Dimensions	Material & Minimum Tensile Strength	Maximum User Capacity	Applicable Standards	Product Image
<u>Type A - with Braided End</u> 8125 8150 8150250 8150300 8150350 8150500 81505 8175 8200 820020	5/8" 3-Strand Rope  25' 50' 75' 100' 150' 200'	Alloy Steel Snap Hook: 5,000 lbs Min with 3,600 lbs Gate Strength  Polyester Rope: 5,600 lbs Min  Carbon Steel Thimble	One user up to 310 lbs (combined weight of user, tools, clothing, etc.)	<b>ANSI</b> Z359.15-2014  <b>OSHA</b> 1926.502 1910.140	
<u>Type B - with Braided End</u> 8149  <u>Type C - with Taped End</u> 8149T	5/8" 3-Strand Rope 50'	Alloy Steel Snap Hook: 5,000 lbs Min with 3,600 lbs Gate Strength  Copolymer Rope: 5,600 lbs Min  Carbon Steel Thimble			
<u>Type D - with Taped End</u> 8125T 8130T 8135T 8150T 8150T1200 8150T325 8151T 8175T 8200T 8201T 820120T	5/8" 3-Strand Rope  20' 25' 30' 50' 75' 100' 200'	Alloy Steel Snap Hook: 5,000 lbs Min with 3,600 lbs Gate Strength  Polyester Rope: 5,600 lbs Min  Carbon Steel Thimble			
<u>Type E - with Two Snap Hooks</u> 8125DH 8150DH 8200DH	5/8" 3-Strand Rope  25' 50' 75' 100'	Alloy Steel Snap Hooks: 5,000 lbs Min with 3,600 lbs Gate Strength  Polyester Rope: 5,600 lbs Min  Carbon Steel Thimble			
<u>Type F - with Braided End</u> 8126 8151 8175DH 8201	5/8" 3-Strand Rope  25' 50' 100'	Polyester Rope: 5,600 lbs Min  Carbon Steel Thimble			
<b>7489</b> Anti-Panic Hinged Fall Arrester	Compatible with all VLLs described in this manual	Alloy Steel Fall Arrester: 3600 lbs Min			
<b>8388</b> 3' Shock Absorbing Lanyard with Anti-Panic Hinged Trailing Grab and ViewPack Cover	Compatible with all VLLs described in this manual	Alloy Steel Fall Arrester: 3,600 lbs Min  Polyester Webbing: 9,800 lbs Min  Alloy Steel Snap Hook: 5,000 lbs Min with 3,600 lbs Gate Strength	One user up to 310 lbs (combined weight of user, tools, clothing, etc.)	<b>ANSI</b> Z359.13-2013 Z359.15-2014  <b>OSHA</b> 1926.502 1910.140	

**The Vertical Lifelines in Table 1 and 2 in this user instruction manual are both ANSI Z359.15-2014 and OSHA 1926.502 compliant. OSHA only compliant fall arresters may be used with these VLLs. See user Table 3 for applicable OSHA only fall arresters.**

Table 2: FallTech Compatible SAL		
8253 8256LT3FT	3' Shock Absorbing Lanyard with ViewPack Cover	

**Table 3: OSHA Only Fall Arresters**

Designation Type and Part #	Dimensions	Material & Minimum Tensile Strength	Maximum User Capacity	Applicable Standards	Product Image
8355 3' Shock Absorbing Lanyard with Trailing/Park Grab and ViewPack Cover	Compatible with all VLLs described in this manual	Alloy Steel Fall Arrester: 3,600 lbs Min  Polyester Webbing: 9,800 lbs Min  Alloy Steel Snaphook: 5,000 lbs Min with 3,600 lbs Gate Strength	One user up to 310 lbs (combined weight of user, tools, clothing, etc.)	OSHA 1926.502 1910.140	
8358 3' Shock Absorbing Lanyard with Hinged Trailing Grab and ViewPack Cover					
8368 3' Shock Absorbing Lanyard with Trailing Grab and ViewPack Cover					
8353 3' Shock Absorbing Lanyard with Manual/Park Grab and ViewPack Cover					
8353LT 3' Shock Absorbing Lanyard with Manual/Park Grab and SoftPack Cover					
8359 3' Shock Absorbing Lanyard with Anti-Panic Hinged Trailing Grab and ViewPack Cover					
7479 Hinged Self-Tracking Fall Arrester		Alloy Steel Fall Arrester: 3600 lbs Min			
7491 Hinged Self-Tracking Fall Arrester Stainless Steel		Stainless Steel Fall Arrester: 3600 lbs Min			