

INSTRUCTION MANUAL

# FRONTLINE<sup>®</sup>

FALL PROTECTION



USER MANUAL

**STEEL/CONCRETE BOLT  
& WELD-ON ANCHOR**

SBW01

Rev. Feb. 2026



Frontline Fall Protection Inc.  
INSTRUCTION MANUAL

This product meets applicable ANSI Z359.18, OSHA 1910 and/or OSHA 1926 fall protection standards.

These instructions apply to the following model(s):

SBW01

Applicable standards and regulations depend on the type of work being done, and also might include state-specific regulations. Refer to local, state, and federal (OSHA) requirements for additional information concerning the governing body of occupational safety regarding Personal Fall Arrest Systems (PFAS).

All users must refer to local, state or federal safety and health regulations before using this equipment. If there's a contradiction between any local, state, federal requirement and/or standard with this manual or within this manual, whichever is the most stringent will apply.

You are required to read and fully understand the user instruction manual BEFORE using this product. Improper use and installation can result in serious injury or death. User manuals occasionally may be updated so for the latest user manual please visit

**[www.frontlinefall.com/uim](http://www.frontlinefall.com/uim)**.

## TABLE OF CONTENTS

Definitions _____	4
General Statement and Warnings _____	6
Training Requirements _____	7
Inspection Requirements _____	11
Product Description _____	12
Application _____	13
Installation _____	14
Maintenance, Storage and Transportation _____	17
Inspection checklist and Log _____	17
Labels _____	18

**DEFINITIONS:** For better use and understanding, the following is some terminology and definitions as referenced by OSHA that may help better understand this user manual. Please refer to OSHA 1910 or 1926 for full details.

#### **Anchorage**

A secure point of attachment for lifelines, lanyards, or deceleration devices.

#### **Attachment Point**

A loop or "D" ring connected (integrally) to the body support that provides a means for attachment of other components of the fall protection system.

#### **Body Harness**

Means straps, which may be secured about the worker in a manner that will distribute the fall arrest forces over at least the thighs, pelvis, waist, chest and shoulders with means for attaching it to other components of a personal fall arrest system.

#### **Carabiner**

A link with a gate that is normally closed or that automatically closes, and is used to connect components of a personal fall protection system.

#### **Competent Person**

Is defined as "one who is capable of identifying existing and predictable hazards in the surroundings or working conditions which are unsanitary, hazardous, or dangerous to employees, and who has authorization to take prompt corrective measures to eliminate them" [29 CFR 1926.32(f)]. By way of training and/or experience, a competent person is knowledgeable of applicable standards, is capable of identifying workplace hazards relating to the specific operation and has the authority to correct them.

#### **Connector**

A device which is used to couple (connect) parts of the personal fall arrest system and positioning device systems. It may be an independent component of the system, such as a carabiner, or it may be an integral component of part of the system (such as a buckle or D-ring sewn into a body belt or body harness, or a snap-hook spliced or sewn to a lanyard or self-retracting lanyard).

#### **D Ring**

A form of attachment point on body belts and fully body harnesses meant for attachment of other components of a fall protection and positioning system.

#### **Deceleration Device**

Means any mechanism that serves to dissipate energy during a fall.

#### **Deceleration Distance**

The vertical distance a falling employee travels from the point at which the deceleration device begins to operate, excluding lifeline elongation and free fall distance, until stopping. It is measured as the distance between the location of an employee's body harness attachment point at the moment of activation (at the onset of fall arrest forces) of the deceleration device during a fall, and the location of that attachment point after the employee comes to a full stop.

#### **Fall Arrest System**

A fall arrest system means a system used to arrest an employee in a fall from a working level. It consists of an anchor point, connectors, a body belt or body harness and may include a lanyard, deceleration device, lifeline, or suitable combinations of these.

#### **Fall Prevention System**

Those systems and techniques that eliminate the possibility of a fall.

#### **Fall Protection System**

Any of the following when used to protect a worker from a fall or minimize the risk from falling: Guardrails, Safety belt or a full body harness with a lanyard and/or lifeline and an anchor, and their related equipment, Safety net, Control zone, Safety monitor with a control zone, and other acceptable procedures.

#### **Fall Restraint System**

A work positioning system to prevent a worker from falling from a work position, or a travel restriction system such as guardrails or a personal fall protection system to prevent a worker from traveling to an edge from which the worker could fall.

#### **Free Fall**

The act of falling before the personal fall arrest system begins to apply force to arrest the fall.

#### **Free Fall Distance**

Vertical displacement of the fall arrest attachment point on the employee's body belt or body harness between onset of the fall and just before the system begins to apply force to arrest the fall. This distance excludes deceleration distance, lifeline and lanyard elongation, but includes any

deceleration device slide distance or self-retracting lifeline/lanyard extension before the devices operate and fall arrest forces occur.

### **Full Body Harness**

A body support device consisting of connected straps designed to distribute a fall arresting force over at least the thigh, shoulders and pelvis, with provision for attaching a lanyard, lifeline or other components.

### **Lanyard**

A flexible line of webbing, synthetic rope or wire rope that is used to secure a safety belt or full body harness to a lifeline or anchor.

### **Horizontal Lifeline System**

A system composed of a synthetic or wire rope installed horizontally between two anchors, to which a worker attaches a personal fall protection system.

### **Leading Edge**

The edge of a floor, roof, or formwork for a floor or other walking or working surface (such as the deck) which changes location as additional floor, roof, decking, or formwork sections are placed, formed, or constructed. A leading edge is considered to be an "unprotected side and edge" during periods when it is not actively and continuously under construction.

### **Lifeline**

A synthetic or wire rope, rigged from one or more anchors, to which a worker's lanyard or other part of a personal fall protection system is attached.

### **Low-Slope Roof**

A roof having a slope less than or equal to 4 in 12 (vertical to horizontal).

### **Lower Levels**

Those areas or surfaces to which a worker can fall. Such areas or surfaces include, but are not limited to, ground levels, floors, platforms, ramps, runways, excavations, pits, tanks, material, water, equipment, structures, or portions thereof.

### **Passive Fall Prevention**

Refers to a system that is non-dynamic, stationary, and does not move, adapt, or change when in or out of use. Passive systems don't require the use of personal protective equipment or active participation from the worker. Typically, passive systems include netting, handrails, and guardrails.

### **Personal Fall Arrest System (PFAS)**

A system used to arrest an employee in a fall from a working level. It consists of an anchorage, connectors, a body belt or body harness and may include a lanyard, deceleration device, lifeline or suitable combinations of these. As of January 1, 1998, the use of a body belt for fall arrest is prohibited.

### **Positioning System (work-positioning system)**

A system of equipment and connectors that, when used with a body harness or body belt, allows an employee to be supported on an elevated vertical surface, such as a wall or window sill, and work with both hands free. Positioning systems also are called "positioning system devices" and "work-positioning equipment".

### **Qualified**

A person who, by possession of a recognized degree, certificate, or professional standing, or who by extensive knowledge, training, and experience has successfully demonstrated the ability to solve or resolve problems relating to the subject matter, the work, or the project.

### **Rope Grab**

A deceleration device which travels on a lifeline and automatically, by friction, engages the lifeline and locks so as to arrest the fall of an employee. A rope grab usually employs the principle of inertial locking, cam/level locking or both (also referred to as a fall arrester).

### **Self-Retracting Lifeline/Lanyard**

A deceleration device containing a drum-wound line, which can be slowly extracted from, or retracted onto, the drum under slight tension during normal worker movement, and which, after onset of a fall, automatically locks the drum and arrests the fall.

### **Shock Absorber**

A device intended to limit the deceleration forces exerted on a worker during fall arrest.

### **Snap Hooks**

A connector consists of a hook-shaped member with a normally closed keeper, or similar arrangement, which may be opened to permit the hook to receive an object and, when released, automatically closes to retain the object.

### **Unprotected Sides and Edges**

Any side or edge (except at entrances to points of access) of a walking or working surface (for

example, floor, roof, ramp, or runway) where there is no wall or guardrail system at least 39 inches high.

### **Walking/Working Surface**

Any surface (whether horizontal or vertical) on which a worker walks or works, including but not limited to floors, roofs, ramps, bridges, runways, formwork and concrete reinforcing steel; but not including ladders, vehicles, or trailers, on which workers must be located in order to perform their job duties.

### **Warning Line System**

A barrier erected on a roof to warn workers that they are approaching an unprotected roof side or edge, and which designates an area in which roofing work may take place without the use of guardrail, body harness, or safety net systems to protect workers in the area.

### **Working load**

Refers to aggregate simultaneous load of personnel, equipment, and/or material to be supported by the equipment or system.

## **GENERAL STATEMENT AND WARNINGS**

This Anchorage Connector is meant to be used **ONLY** by trained personnel in fall protection. This anchorage connected is **ONLY** intended for use as part of a complete personal fall protection system. This anchorage connector has been designed to meet or exceed ANSI Z359.18, OSHA 1926 and/or OSHA 1910.

User **MUST** read, understand, and follow all safety information contained in these instructions prior to the use of this Anchorage Connector. Use in any other applications including, but not limited to, material handling, recreational or sports related activities, or other activities not described in the User Instructions is not approved by Frontline Fall Protection and could result in serious injury or death. This device is only to be used by trained users in workplace applications.

These instructions must be provided to the user of this equipment. Retain these instructions for future reference or you can find a copy of them at [www.frontlinefall.com](http://www.frontlinefall.com) for more information regarding any portion of this user instructions manual please contact us at [info@frontlinefall.com](mailto:info@frontlinefall.com).

- Do not use this equipment until proper training, fall protection and rescue programs are in place.
- Do not use this equipment in combination with other components or subsystems other than those described in this manual.
- Do not use this equipment for other uses other than its original and designed intended use.
- Do not use product that has been impacted to a fall, that does not pass inspection or that the safety and integrity of it is questionable.
- Consult a doctor prior using this equipment to ensure user is in physical conditions to use this equipment and if physical fit in the event there's a fall.
- Pregnant women or minors must not be exposed to a workplace hazard and must not use this equipment.
- Avoid sharp and/or abrasive surfaces and edges as this will compromise the safety of the Personal Fall Arrest System.
- All user must refer to local, state or federal safety and health regulations before using this equipment. Whichever is most stringent shall supersede and apply.
- Avoid moving machinery, thermal, electrical, and/or chemical hazards as contact may cause serious injury or death.
- Avoid swing falls at all times when using Personal Fall Arrest Systems.
- Follow the weight restrictions/limitations in this manual.
- Never alter or intentionally misuse this equipment, always inspect before each use to ensure its compliance and safe use.
- Never connect rebar hooks, large carabiners, large snaphooks or non- approved hooks/connectors to the full body harnesses dorsal D-rings as this may cause a roll-out and/or unintentional disengagement.
- Avoid contact with arc flash welding at all times. Arc flash from arc welding operations, including accidental arcs from electrical equipment, can damage the PFAS equipment resulting in injury or death.
- Always examine the work area and the surroundings to identify hazards that may impact safety and proper functioning of the Personal Fall Arrest System before commencing work.

- Only one fall protection system or positioning system may be attached to an individual connection point.

## TRAINING REQUIREMENTS

Before using Frontline Fall Protection product, user and employers must ensure that the person using this equipment has been trained on the proper use, care and maintenance of this product by a competent person qualified in Fall Protection. It is the responsibility of the user of this product to ensure that proper training has been done in addition to reading and fully understanding these user instructions manual.

Additionally, the employer must establish a training program to employees that are exposed to a fall hazard and trained by a competent person qualified in those areas. The program shall enable each employee to recognize the hazards of falling and shall train each employee in the procedures to be followed in order to minimize these hazards.

Retraining is necessary when the employer has reason to believe that any affected employee who has already been trained does not have the understanding and skill to carry out those duties. Circumstances where retraining is required include, but are not limited to, situations where:

- Changes in the workplace render previous training obsolete.
- Changes in the types of fall protection systems or equipment to be used render previous training obsolete.
- Inadequacies in an affected employee's knowledge or use of fall protection systems or equipment indicate that the employee has not retained the requisite understanding or skill.
- Changes in the OSHA regulations or ANSI Standards.

Training must be done in the language that the employee understands and shall, be documented and kept as outlined under OSHA recordkeeping regulations. No user or employee shall perform work without the proper training and understanding on how to properly and safely use this product.

## SYSTEM REQUIREMENTS

**Compatible Connectors:** In order to use Frontline Fall Protection Anchors, connecting devices must include a compatible connector. Compatible connectors must be approved Snaphooks or carabiner which meet OSHA and ANSI standards to be compatible with the member to which they are connected to prevent unintentional disengagement. Snaphooks or carabiners shall be of locking type designed and used to prevent disengagement of the Snaphooks by the contact of the Snaphooks keeper by the connected member.

Frontline PFAS equipment must be used with Frontline equipment only. If a qualified person deems that other manufacturer equipment is compatible, it is under the sole discretion and responsibility of that qualified person and Frontline assumes no responsibility for any issues arising of any incompatibilities or any liability should there be an incident, fall or accident.

**Structural Requirement:** It is the requirement of the installer and user of the equipment that the substrate where the anchor is being installed can withstand a minimum breaking strength of 5,000 lbs per person or as part of a complete personal fall arrest system which maintains a safety factor of at least two; and under the supervision and approval of a qualified person.

**Anchorage Substrate Connection:** Frontline has tested their product to comply with OSHA and/ or ANSI under a controlled environment and with certain substrates. Frontline cannot and does not guarantee the same performance for different substrates. Frontline anchors will meet or exceed OSHA and/or ANSI requirements, but it's ultimately up-to the end user/installer/owner of the product to ensure that their specific substrate will resist and withstand the required loads as stated by OSHA and/or ANSI or other governing safety entities. OSHA and/or ANSI anchor compliance and testing covers only the anchor and does not extend to the substrate to which the anchorage or connector is attached to. Please contact [info@frontlinefall.com](mailto:info@frontlinefall.com) if you have any questions regarding this subject matter.

**Making connections:** When making the anchor connecting device connection, ensure that the

connecting equipment is compatible and meets or exceeds OSHA and ANSI standards. Once connected, visually inspect the connection and perform a pull test to ensure that the equipment is locked and fully functioning. If equipment is not working properly or the safety integrity is in question, do NOT use and consult with Qualified Person. No more than one PFAS may be connected to a Fall Arrest Anchor at one time.

Ensure all connections are compatible in size, shape and strength. Do not use equipment that is not compatible. Ensure all connectors are fully closed and locked and that there's only one connection point per anchor per person. Perform a few pull tests to verify that the connection has been effective.

Frontline connectors (Snaphooks and carabiners) are designed to be used only as specified in each product's user's instructions. See figure 2 for examples of inappropriate connections.

**FIGURE 1 - NON-COMPATIBLE CONNECTIONS**



DO NOT connect two snaphooks or carabiners to each other.



DO NOT connect two snaphooks or carabiners to a single D-ring at the same time.



DO NOT connect in a way that would create a loading on the gate.

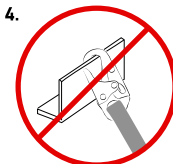

DO NOT attach to an object in a manner where the gate of the snap hook or carabiner would be prevented from fully locking. Always visibly inspect for proper and full closure of the snap hook or carabiner



DO NOT attach directly back into the component itself such as webbing, cable, or rope, unless specifically allowed by manufacturer and instructions.



DO NOT attach in manner where the connector, gate or release lever, may become caught on the anchor causing additional risk of false connection.



DO NOT attach a double snaphook to two side/positioning D-rings in a manner whereby the D-rings will engage the gates.

**NOTE:** Large snap hooks must not be connected to objects which will result in load on the gate if the hook twists or rotates, unless the snap hook complies with ANSI Z359.1-2007 or ANSI Z359.12 and is equipped with a 3,600 lb (16 kN) gate. Check the marking on your snap hook to verify it's compatibility.

**Personal Fall Arrest System:** All PFAS used with this equipment must meet OSHA and ANSI Z359 requirements. A full body harness along with a compliant connecting device must be worn when this equipment is used as a component of a PFAS. As required by OSHA, the PFAS must be able to arrest the user's fall with a maximum arresting force of 1,800 lbs (8 kN), and limit the free fall to 6 ft (1.8 m). Once equipment is subject to a fall or an impact, equipment must be removed from service.

**Structure Mounting Strength:** The structure and mounting hardware must be capable of withstanding at least 5,000 pounds (22.2 kN) per employee attached. Installations MUST comply with all Federal, State, and local regulation standards and be approved by a Qualified Person before use.

**Structure Mounting Selection:** When selecting a mounting structure, there are various factors to be considered. Some which are described below, but not all inclusive:

- Select a structural component that can withstand a minimum breaking strength of 5,000 lbs.
- Select a work area, that will be free of obstructions.
- Select a work area, that will be free of any other recognizable safety hazards.
- Select and overhead anchor when possible. If overhead anchor is not possible, ensure that all the equipment used to connect the anchor is rated for below the waist tie-off.
- Ensure there are no swing hazards.

If the user is unable to determine whether the anchorage meets the manufacturer's specification, please contact Frontline at [info@frontlinefall.com](mailto:info@frontlinefall.com)

**Before Working with your PFAS:** It is required that before using PFAS, a fall protection plan should be in place and used including the working conditions and equipment to be used. Here are some aspects, but not all inclusive, of the items that need to be included in a fall protection plan:

- End user training on the safe use, care and maintenance of equipment and jobsite conditions prior to commencing work.
- Inspection procedures.
- Fall clearances and potential swing falls.
- Proper structure/substrate anchoring to withstand the minimum required loads.
- A rescue plan in case end user or someone is subject to a fall.

**Total Fall Clearance for PFAS:** According to OSHA, the total fall clearance distance is the minimum vertical distance between the worker and the lower level that is necessary to ensure the worker does not contact a lower level during a fall. The total fall clearance distance needs to be calculated by the user/employer before a decision is made to use a PFAS. If the available distance is not greater than the total fall clearance distance, it is inappropriate to use the PFAS and a fall restraint system might be used instead. Total fall clearance distance calculations are simple to perform based on several factors, including but not all inclusive:

- Lanyard/Self Retracting Lifeline length which may vary depending on the device being used and their specifications. See connecting device user manual for more information.
- The height at which the lanyard is anchored relative to where the other end attaches to the worker's harness.
- The distance the worker will travel as the deceleration device absorbs the energy from the fall (i.e., slows it down.)
- The worker's height.
- D-ring shift and a safety factor.

Below are illustrations to help guide the user to determine minimum fall clearances and swing hazards:

**FIGURE 2**

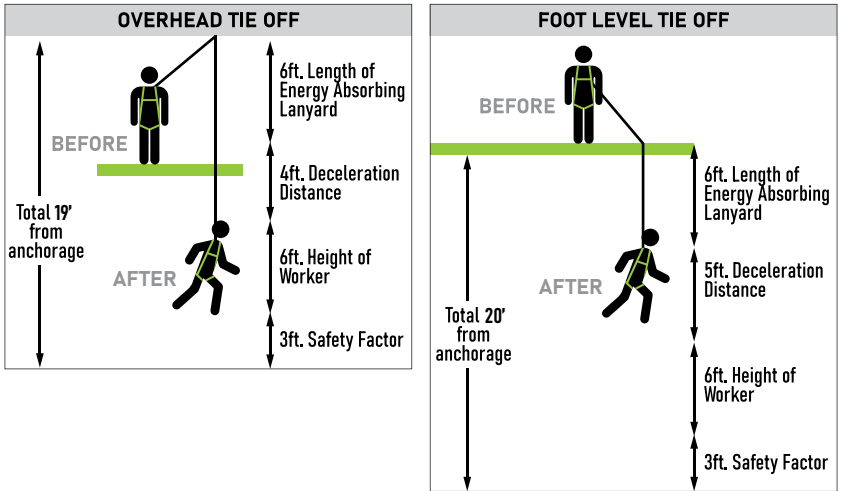

**FIGURE 3**

- A)** Connecting Subsystem (Energy Absorbing Lanyard Shown)
- B)** Working Level Shown
- C)** Lower Level or Obstruction
- D)** Free Fall - 6ft. (1.8m) Max. (per ANSI Z 359.11)
- E)** Deceleration Distance
- F)** Total Fall Distance Free Fall (D) + Deceleration (E)

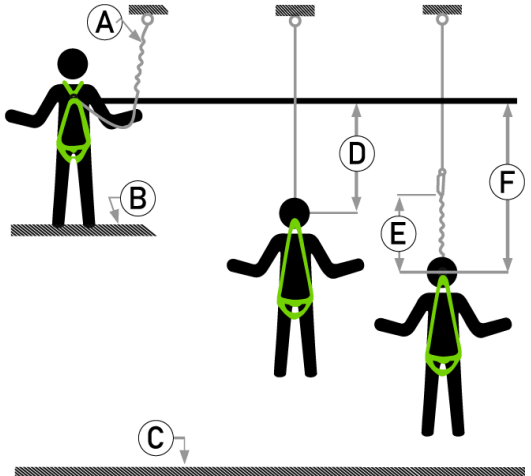

\*This information is for reference only, it's ultimately up to the employer/user of the product to make the correct fall clearance calculations as there varying factors that can impact the distance.

**Swing Fall:** Swing fall hazards or pendulum effect occurs when the anchorage is not directly overhead and/or there is some lateral distance away from the falling worker. In cases where the anchorage is not completely directly overhead, or behind/underneath if the anchor is anchored below the waist or at foot level, the total fall distance and pendulum struck by hazards can increase significantly.

Users must always be anchored overhead and working directly underneath the anchor. When the anchor is installed at waist or foot level, then users must work within approved working angles and direction loading as per specific anchor requirements.

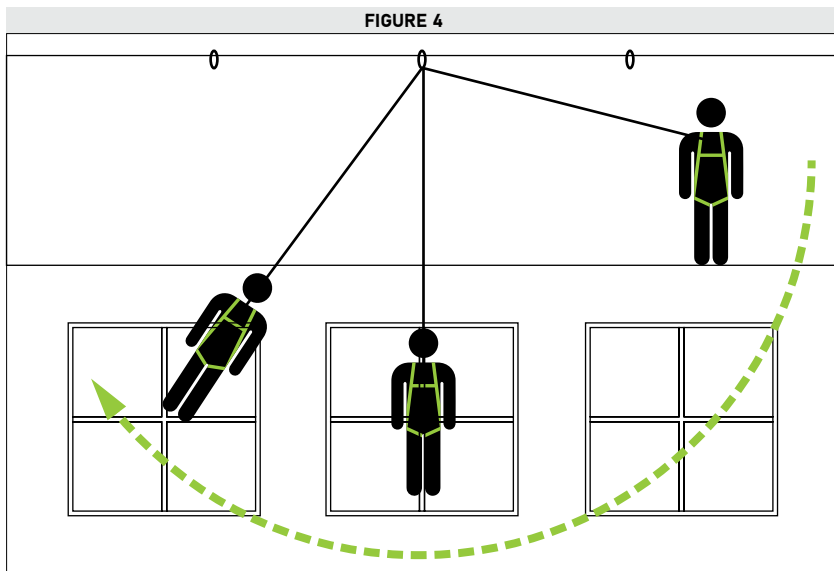

Employer/user must avoid swing hazards at all times. See Direction Loading and approved angles for specific anchor to avoid swing hazards or even anchor failure.

### **INSPECTION REQUIREMENTS**

This anchor and any other PFAS shall be inspected BEFORE each use. The program administrator, authorized user and/or rescuer inspecting the product shall have the proper training on the use, maintenance, care and inspection of this product. Additionally, a competent or qualified person other than the user shall conduct thorough safety inspections every 6 months or sooner, when necessary or required by the authorized user or employer. Some of the items that shall be inspected, but not all inclusive, are the following:

- Safety labels/markings/tags that are legible with appropriate OSHA/ANSI markings, product limitations, user capacity and other markings as required by OSHA/ANSI.
- Defects or any imperfections on the products such as; Corrosion, broken, bent, deformed, excessive wear, defects in welded areas or any other evidence of damage or alterations affecting the safety functionality of the anchor.
- Any other conditions that may question the integrity of the anchor, shall be put out of service.
- Any product that has been subject to a fall or an impact, shall be put out of service.

- Clean/clear product of any surface contamination such as concrete, stucco, roofing material or other material that may impact the safe use of the product.
- Any damage to the equipment or inadequate maintenance.
- The details of the "Inspection Checklist and Log" at the end of this manual.

Permanently remove equipment from service that does not pass any of these inspection criteria, hasn't undergone preventative service or maintenance requirements or if the equipment is questionable.

As required by ANSI Z359.18 6.1.2/6.1.3, the "The program administrator shall set inspection criteria for the equipment. Such criteria shall equal or exceed the most restrictive of the criteria established by this standard or the manufacturer's user instructions. Keep inspection criteria current in relationship to changing patterns or conditions of use. The program administrator shall maintain documentation of equipment inspections. This documentation shall include, at a minimum, the identity of the equipment, inspection date, name of the competent or qualified person conducting the inspection and the results of that inspection."

These are minimum requirements, and all inspections should be documented for recordkeeping. Any questions regarding the safety inspection of Frontline Fall Protection products please contact us at [info@frontlinefall.com](mailto:info@frontlinefall.com).

## PRODUCT DESCRIPTION

The Frontline fall arrest Steel and Concrete, Weld/Bolt-on Anchor is a single person anchor. This type of anchor is used for temporary or permanent use and can be used on concrete slabs/columns or steel beams/columns that meet the requirement within this manual.



<b>SYSTEM SPECIFICATIONS:</b>	
<b>USER CAPACITY:</b>	1 Person with a combined weight (clothing, tools, etc.) of no more than: 310 lbs.
<b>SERVICE TEMPERATURE:</b>	-30°F to +130°F Minimum Service Temperatures
<b>BREAKING STRENGTH:</b>	5,000 lbs Minimum Breaking Strength
<b>MATERIAL:</b>	ASTM A36 Rated Steel D-Ring: Forged Steel Finish: Zinc-Plated
<b>DIMENSIONS:</b>	4 3/4" x 2" x 1/4"
<b>WEIGHT:</b>	1 lb
<b>USE:</b>	Permanent or temporary reusable anchor

## APPLICATION

This Anchorage Connector has been tested for compliance with the requirements of OSHA and/or ANSI requirements. Testing covers only the Anchorage Connector and does not extend to the connector, body harness, subsystem and/or substrate to which the Anchorage Connector is attached to.

Prior to installation and use of this equipment, record the product identification information from the label in the Inspection and Maintenance Log at the end of this manual. Use a pen or fine point sharpie with blue or black ink when logging inspections.

**Purpose:** The Frontline Fall Arrest Anchors are designed to be used as a component in a Personal Fall Arrest System (PFAS) Frontline Fall Arrest Anchors are tested to meet or exceed applicable OSHA and/or ANSI standards so employees can work safely tie-off while maintaining mobility and being productive when using Anchorage Connector.

**Approved Applications:** Below are applications for which all Frontline Fall Arrest Anchors are best used in. This list is intended to define the approved applications in which this product may be used:

APPROVED APPLICATIONS CHART		
APPLICATION	DESCRIPTION	APPROVED APPLICATION
<b>PERSONAL FALL ARREST</b>	Person fall arrest is when the application where the user can be subject to a fall. The anchorage needs to be used in conjunction with approved connecting device such as a lanyard or self-retracting lifeline and a harness. Maximum permissible free fall is 6 ft (1.8 m). Anchorages selected for fall arrest systems shall be able to sustaining static loads applied in the directions permitted by the system of at least 5,000 lbs (23 kN) for non-certified anchorages or two times the maximum arresting force for certified anchorages.	X
<b>RESTRAINT</b>	Restraint is the application used by the user where the user is limited in distance so they cannot reach or be exposed to a fall hazard. Restraint systems shall have the strength capable of sustaining static loads applied to all directions permitted by the system and; No less than 1,000 lbs for non-certified field anchorages and two times the foreseeable force for certified anchorages or as determined by ANSI/ASSE Z359.6 and/or OSHA. This system also is composed of the anchorage, connecting device such as a lanyard or self-retracting lifeline and a harness.	X
<b>WORK POSITIONING</b>	Positioning devices shall be secured to an anchorage capable of supporting at least twice the potential impact load of an employees fall or 3,000 pounds (13.3 kN), whichever is greater. This system also is composed of the anchorage, connecting device such as a lanyard or self-retracting lifeline and a harness.	X

## INSTALLATION

### CONCRETE INSTALLATION

When installing onto concrete Frontline requires only fully cured concrete and a minimum strength of 3,000 psi 6" thick concrete. The substrate also must withstand the required 5,000 lbs minimum breaking strength and approved before use by a qualified person. Thereafter, then follow the next steps:

1. Use (2) 4" X 1/2" concrete wedge anchors – must be rated at 6,000 lbs or more.
2. Ensure that anchor is flat, flush and d-ring facing upwards on the concrete surface without any obstructions.
3. Drill the two holes 1/2" by 3" in depth so the 1/2" concrete wedge anchors can fit snug and be properly installed.
  - a. For proper concrete wedge installation refer to wedge anchor manufacturer's instructions.
  - b. Anchors must be embedded into the concrete a minimum 3" in depth.
  - c. Clean the hole for any debris after drilling.
  - d. Insert the 2 concrete wedge anchors through the anchor openings.
  - e. Assemble the washer and nut onto the bolt.
  - f. Tighten wedge anchors until they are completely secured and with the appropriate torque according to wedge bolt anchor manufacturer recommendations.
4. Visually and physically inspect that the anchor is fully and properly installed.
5. Once correctly installed and inspected, anchor is ready for use with the compatible additional PFAS.

**WARNING:** Concrete cannot be hollow, must be fully cured and able to withstand the rated loads or as part of a complete personal fall arrest system which maintains a safety factor of at least two under the supervision of a qualified person as described by OSHA.

FIGURE 5

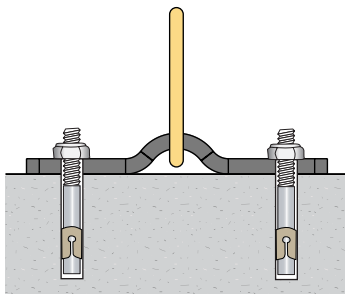

Concrete Slab

## FIELD WELD-ON INSTALLATION

When welding onto structural steel or I-Beams Frontline requires that I-Beam has a minimum flange width of 4" and welding is done by AWS certified welder in accordance with applicable welding regulations. The substrate also must withstand the required 5,000 lbs minimum breaking strength and approved before use by a qualified person. Thereafter, then follow the next steps:

1. Use appropriate welding and respiratory PPE before installing
2. Anchor is zinc-plated, so it is suggested that the sides of zinc-plating of the steel plate be removed by grinding or similar methods in order to weld to structure and accordingly to AWS standards.
3. Identify anchor location and make sure is clean and free of obstructions.
4. Place anchor flat, flush and d-ring facing upwards and centered on I-Beam surface and fillet weld all around anchor with 3/8" weld as shown on Figure 6.
5. Let anchor cool, and then apply 2 coats or more of a rust preventative coating to all field weld
6. Once correctly installed and inspected, anchor is ready for use with the compatible additional PFAS.

**FIGURE 6**

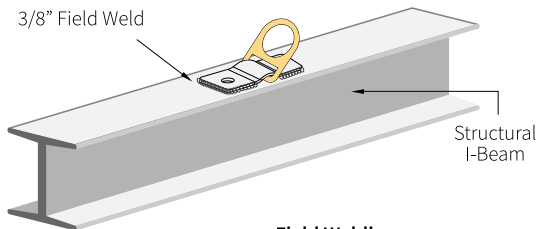

### **Field Welding**

Apply 2 coats or more of a rust preventative coating to all field welds

## FIELD BOLT-ON INSTALLATION

When bolting onto structural steel or I-Beams Frontline requires that I-Beam can withstand the required 5,000 lbs minimum breaking strength and approved before use by a qualified person. Thereafter, then follow the next steps:

1. Identify anchor location and make sure is clean and free of obstructions.
2. Place anchor flat, flush and d-ring facing upwards and centered on I-Beam surface.
3. Use (2) 1/2" diameter, Grade 8 steel bolts (length will depend on thickness of I-Beam).
4. Perforate the I-beam on desired location so the two bolts can be inserted through I-beam and anchor openings.
5. Insert washers and then lock nuts in opposite side of flange through the bolts. Lock nuts and washers must be fully inserted on the thread of the bolt, tightened and secured.

6. Once correctly installed and inspected, anchor is ready for use with the compatible additional PFAS.

FIGURE 7

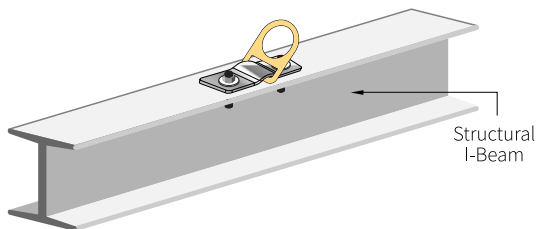

**WARNING:** Make sure bolts are always properly secured and of tight fit and never lose. Structural steel or I-Beam must also be fully secured to the building structure and be able to withstand minimum breaking strength of 5,000 lbs or as part of a complete personal fall arrest system which maintains a safety factor of at least two under the supervision of a qualified person as described by OSHA.

#### DIRECTION LOADING

Anchor is approved to be used in all directions. Anchor cannot be used over a concrete/steel edge. The anchor cannot be installed within 6" to the edge of a concrete substrate and cannot be used in a pull out direction. Refer to the Anchor Positioning Chart for allowable distances and angels to reduce swing falls.

FIGURE 8

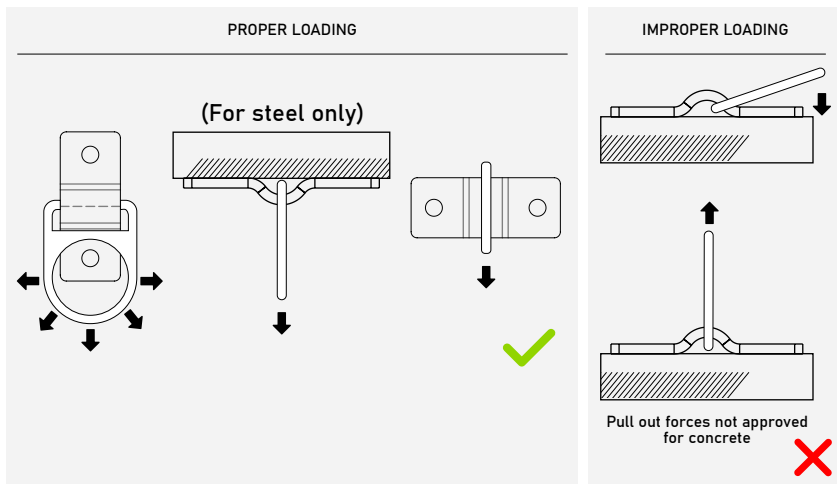

## MAINTENANCE, STORAGE AND TRANSPORTATION

**MAINTENANCE:** In order to maintain product in good standing, it is necessary to keep them cleaned and in good condition. Avoid surface contamination such as concrete, stucco, roofing material, chemicals or other harmful substances that could accelerate cutting, abrading, damaging and/or rusting/corroding of products. Use warm water and soap to wash any containments and then dry off to help extend the life of the product.

Product that needs to undergo deeper maintenance and repairs outside of cleaning with warm water and soap is not recommended. Any rust preventative measures, chemical exposures repairs/maintenance and/or other deeper maintenance are in the sole responsibility of the user and must be approved by a qualified person. Frontline assumes and takes no responsibility for maintenance measures outside of light maintenance as described above. Product that does not pass inspection or is questionable needs to be taken out of service immediately.

**STORAGE:** If products are not temporarily or permanently installed, when possible, all products shall be stored at room temperature in indoor space, lockers or in a clean area away from sunlight, rain and other environmental conditions. Products should be also stored where they are not exposed to chemical, oils, paint, concrete, or other contaminants that might compromise the integrity of the product. Equipment that has been physically exposed such as rain/dirty water, concrete, paint, buildup of other construction material or other surface contamination shall be cleaned and dried before storage.

**TRANSPORTATION:** Ensure to transport product where it doesn't beat up against other products as this might cause damage to products and terminate the use of them. Product also should not be transported with harmful substances or chemicals as this might also compromised the integrity of the product.

### INSPECTION CHECKLIST AND LOG

MODEL NUMBER:		DATE OF FIRST USE:	
<b>INSPECTION:</b>	Prior to installation and prior to each use / Inspection by a competent person is required every 6 months.	<b>PASS</b>	<b>FAIL</b>
<b>ANCHORAGE:</b>	Inspect the Anchor for damage: Look for cracks, dents, or deformities.	<input type="checkbox"/>	<input type="checkbox"/>
	Inspect for permanent deformation.	<input type="checkbox"/>	<input type="checkbox"/>
	Inspect the entire unit for corrosion.	<input type="checkbox"/>	<input type="checkbox"/>
	Make sure all fasteners are completely and correctly installed when in use	<input type="checkbox"/>	<input type="checkbox"/>
	Inspect for any other unconformity.	<input type="checkbox"/>	<input type="checkbox"/>
<b>LABELS</b>	Inspect the Anchor for legible labels.	<input type="checkbox"/>	<input type="checkbox"/>
<b>PFAS AND OTHER EQUIPMENT</b>	Additional Personal Fall Arrest System (PFAS) equipment (harness, SRL, etc.) that are used with the Anchorage System should be installed and inspected per the manufacturer's instructions.	<input type="checkbox"/>	<input type="checkbox"/>







Frontline Fall Protection Inc.

[www.frontlinefall.com](http://www.frontlinefall.com)

[info@frontlinefall.com](mailto:info@frontlinefall.com)

©2026 Frontline