

INSTRUCTION **MANUAL**

FRONTLINE[®]

FALL PROTECTION



USER MANUAL

BEAM ANCHOR

ST12AH, ST18AH

Meets or exceeds
applicable standards

Rev. April 2025



Frontline Fall Protection Inc.
INSTRUCTION MANUAL

This product meets applicable ANSI Z359.18, OSHA 1910
and OSHA 1926 fall protection standards.

ANSI Z359.18 Type A

These instructions apply to the following model(s):

ST12AH and ST18AH

Applicable standards and regulations depend on the type of work being done, and also might include state-specific regulations. Refer to local, state, and federal (OSHA) requirements for additional information concerning the governing body of occupational safety regarding Personal Fall Arrest Systems (PFAS).

You are required to read and fully understand the user instruction manual BEFORE using this product. Improper use and installation can result in serious injury or death. User manuals occasionally may be updated so for the latest user manual please visit www.frontlinefall.com/uim.

TABLE OF CONTENTS

Definitions	4
General Statement and Warnings	8
Training Requirements	9
Description	10
Application	10
System Requirements	12
Installation	18
Maintenance, Service, and Storage	21

DEFINITIONS

Anchorage

A secure point of attachment for lifelines, lanyards, or deceleration devices.

Attachment Point

A loop or "D" ring connected (integrally) to the body support that provides a means for attachment of other components of the fall protection system.

Body Harness

Means straps, which may be secured about the worker in a manner that will distribute the fall arrest forces over at least the thighs, pelvis, waist, chest and shoulders with means for attaching it to other components of a personal fall arrest system.

Carabiner

A link with a gate that is normally closed or that automatically closes, and is used to connect components of a personal fall protection system.

Competent Person

Is defined as "one who is capable of identifying existing and predictable hazards in the surroundings or working conditions which are unsanitary, hazardous, or dangerous to employees, and who has authorization to take prompt corrective measures to eliminate them" [29 CFR 1926.32(f)]. By way of training and/or experience, a competent person is knowledgeable of applicable standards, is capable of identifying workplace hazards relating to the specific operation and has the authority to correct them.

Connector

A device which is used to couple (connect) parts of the personal fall arrest system and positioning device systems. It may be an independent component of the system, such as a carabiner, or it may be an integral component of part of the system (such as a buckle or D-ring sewn into a body belt or body harness, or a snap-hook spliced or sewn to a lanyard or self-retracting lanyard).

D Ring

A form of attachment point on body belts and fully body harnesses meant for attachment of other components of a fall protection and positioning system.

Deceleration Device

Means any mechanism that serves to dissipate energy during a fall.

Deceleration Distance

The vertical distance a falling employee travels from the point at which the deceleration device begins to operate, excluding lifeline elongation and free fall distance, until stopping. It is measured as the distance between the location of an employee's body harness attachment point at the moment of activation (at the onset of fall arrest forces) of the deceleration device during a fall, and the

location of that attachment point after the employee comes to a full stop.

Fall Arrest System

A fall arrest system means a system used to arrest an employee in a fall from a working level. It consists of an anchor point, connectors, a body belt or body harness and may include a lanyard, deceleration device, lifeline, or suitable combinations of these.

Fall Prevention System

Those systems and techniques that eliminate the possibility of a fall.

Fall Protection System

Any of the following when used to protect a worker from a fall or minimize the risk from falling: Guardrails, Safety belt or a full body harness with a lanyard and/or lifeline and an anchor, and their related equipment, Safety net, Control zone, Safety monitor with a control zone, and other acceptable procedures.

Fall Restraint System

A work positioning system to prevent a worker from falling from a work position, or a travel restriction system such as guardrails or a personal fall protection system to prevent a worker from traveling to an edge from which the worker could fall.

Free Fall

The act of falling before the personal fall arrest system begins to apply force to arrest the fall.

Free Fall Distance

Vertical displacement of the fall arrest attachment point on the employee's body belt or body harness between onset of the fall and just before the system begins to apply force to arrest the fall. This distance excludes deceleration distance, lifeline and lanyard elongation, but includes any deceleration device slide distance or self-retracting lifeline/lanyard extension before the devices operate and fall arrest forces occur.

Full Body Harness

A body support device consisting of connected straps designed to distribute a fall arresting force over at least the thigh, shoulders and pelvis, with provision for attaching a lanyard, lifeline or other components.

Lanyard

A flexible line of webbing, synthetic rope or wire rope that is used to secure a safety belt or full body harness to a lifeline or anchor.

Horizontal Lifeline System

A system composed of a synthetic or wire rope installed horizontally between two anchors, to which a worker attaches a personal fall protection system.

Leading Edge

The edge of a floor, roof, or formwork for a floor or other walking or working surface (such as the deck) which changes location as additional floor, roof, decking, or formwork sections are placed, formed, or constructed. A leading edge is considered to be an “unprotected side and edge” during periods when it is not actively and continuously under construction.

Lifeline

A synthetic or wire rope, rigged from one or more anchors, to which a worker’s lanyard or other part of a personal fall protection system is attached.

Low-Slope Roof

A roof having a slope less than or equal to 4 in 12 (vertical to horizontal).

Lower Levels

Those areas or surfaces to which a worker can fall. Such areas or surfaces include, but are not limited to, ground levels, floors, platforms, ramps, runways, excavations, pits, tanks, material, water, equipment, structures, or portions thereof.

Passive Fall Prevention

Refers to a system that is non-dynamic, stationary, and does not move, adapt, or change when in or out of use. Passive systems don’t require the use of personal protective equipment or active participation from the worker. Typically, passive systems include netting, handrails, and guardrails.

Personal Fall Arrest System

A system used to arrest an employee in a fall from a working level. It consists of an anchorage, connectors, a body belt or body harness and may include a lanyard, deceleration device, lifeline or suitable combinations of these. As of January 1, 1998, the use of a body belt for fall arrest is prohibited.

Positioning System (work-positioning system)

A system of equipment and connectors that, when used with a body harness or body belt, allows an employee to be supported on an elevated vertical surface, such as a wall or window sill, and work with both hands free. Positioning systems also are called “positioning system devices” and “work-positioning equipment”.

Qualified

A person who, by possession of a recognized degree, certificate, or professional standing, or who by extensive knowledge, training, and experience has successfully demonstrated the ability to solve or resolve problems relating to the subject matter, the work, or the project.

Rope Grab

A deceleration device which travels on a lifeline and automatically, by friction, engages the lifeline and locks so as to arrest the fall of an employee. A rope grab usually employs the principle of inertial locking, cam/level locking or both

(also referred to as a fall arrester).

Self-Retracting Lifeline/Lanyard

A deceleration device containing a drum-wound line, which can be slowly extracted from, or retracted onto, the drum under slight tension during normal worker movement, and which, after onset of a fall, automatically locks the drum and arrests the fall.

Shock Absorber

A device intended to limit the deceleration forces exerted on a worker during fall arrest.

Snap Hooks

A connector consists of a hook-shaped member with a normally closed keeper, or similar arrangement, which may be opened to permit the hook to receive an object and, when released, automatically closes to retain the object.

Unprotected Sides and Edges

Any side or edge (except at entrances to points of access) of a walking or working surface (for example, floor, roof, ramp, or runway) where there is no wall or guardrail system at least 39 inches high.

Walking/Working Surface

Any surface (whether horizontal or vertical) on which a worker walks or works, including but not limited to floors, roofs, ramps, bridges, runways, formwork and concrete reinforcing steel; but not including ladders, vehicles, or trailers, on which workers must be located in order to perform their job duties.

Warning Line System

A barrier erected on a roof to warn workers that they are approaching an unprotected roof side or edge, and which designates an area in which roofing work may take place without the use of guardrail, body harness, or safety net systems to protect workers in the area.

Working load

Refers to aggregate simultaneous load of personnel, equipment, and/or material to be supported by the equipment or system.

GENERAL STATEMENT AND WARNINGS

This Anchorage Connector is meant to be used ONLY by trained personnel in fall protection. This anchorage connected is ONLY intended for use as part of a complete personal fall protection system. This anchorage connector has been designed to meet or exceed ANSI Z359.18, OSHA 1926 and OSHA 1910.

User MUST read, understand, and follow all safety information contained in these instructions prior to the use of this Anchorage Connector. Use in any other applications including, but not limited to, material handling, recreational or sports related activities, or other activities not described in the User Instructions is not approved by Frontline Fall Protection and could result in serious injury or death. This device is only to be used by trained users in workplace applications.

These instructions must be provided to the user of this equipment. Retain these instructions for future reference or you can find a copy of them at www.frontlinefall.com. For more information regarding any portion of this user instructions manual please contact us at info@frontlinefall.com.

- Do not use this equipment until proper training, fall protection and rescue programs are in place.
- Do not use this equipment in combination with other components or subsystems other than those described in this manual.
- Do not use this is equipment for other uses other than its original and designed intended use.
- Do not use product that has been impacted to a fall, that does not pass inspection or that the safety and integrity of it is questionable.
- Consult a doctor prior using this equipment to ensure user is in physical conditions to use this equipment and if physical fit in the event there's a fall.
- Pregnant women or minors must not be exposed to a workplace hazard and must not use this equipment.
- Avoid sharp and/or abrasive surfaces and edges as this will compromise the safety of the Personal Fall Arrest System.
- All user must refer to local, state or federal safety and health regulations before using this equipment. Whichever is most stringent shall supersede and apply.
- Avoid moving machinery, thermal, electrical, and/or chemical hazards as contact may cause serious injury or death.
- Avoid swing falls at all times when using Personal Fall Arrest Systems.
- Follow the weight restrictions/limitations in this manual.

- Never alter or intentionally misuse this equipment, always inspect before each use to ensure its compliance and safe use.
- Never connect rebar hooks, large carabiners, large snaphooks or non-approved hooks/connectors to the full body harnesses dorsal D-rings as this may cause a roll-out and/or unintentional disengagement.
- Avoid contact with arc flash welding at all times. Arc flash from arc welding operations, including accidental arcs from electrical equipment, can damage the PFAS equipment resulting in injury or death.
- Always examine the work area and the surroundings to identify hazards that may impact safety and proper functioning of the Personal Fall Arrest System before commencing work.

TRAINING REQUIREMENTS

Before using Frontline Fall Protection product, user and employers must ensure that the person using this equipment has been trained on the proper use, care and maintenance of this product by a competent person qualified in Fall Protection. It is the responsibility of the user of this product to ensure that proper training has been done in addition to reading and fully understanding these user instructions manual.

Additionally, the employer should establish a training program to employees that are exposed to a fall hazard and trained by a competent person qualified in those areas. The program shall enable each employee to recognize the hazards of falling and shall train each employee in the procedures to be followed in order to minimize these hazards.

Retraining is necessary when the employer has reason to believe that any affected employee who has already been trained does not have the understanding and skill to carry out those duties. Circumstances where retraining is required include, but are not limited to, situations where:

- Changes in the workplace render previous training obsolete.
- Changes in the types of fall protection systems or equipment to be used render previous training obsolete.
- Inadequacies in an affected employee's knowledge or use of fall protection systems or equipment indicate that the employee has not retained the requisite understanding or skill.
- Changes in the OSHA regulations or ANSI Standard.

Training must be done in the language that the employee understands and shall,

be documented and kept as outlined under OSHA recordkeeping regulations. No user or employee shall perform work without the proper training and understanding on how to properly and safely use this product.

DESCRIPTION

The Frontline Vertical/Horizontal Beam Anchor is a fixed I-beam anchor that is easy to operate and designed to clamp onto a vertical or horizontal I-beam to create a fixed anchor point.

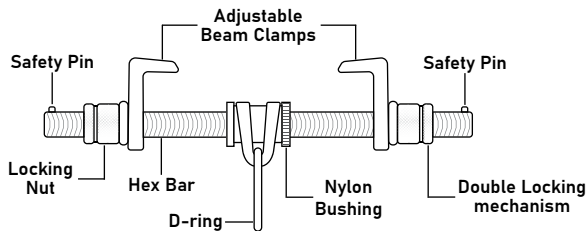

Part Number	Description	Flange Width Ranging	Max. Flange Thickness	Anchor Weight
ST18AH	Horizontal Beam Anchor	3 1/2" - 18"	1"	5.64 lbs
ST12AH	Horizontal Beam Anchor	3 1/2" - 12"	1"	4.81 lbs

APPLICATION

This Anchorage Connector has been tested for compliance with the requirements of ANSI/ASSE Z359.18-2017. Testing covers only the Anchorage Connector and does not extend to the connector, body harness, subsystem and/or substrate to which the Anchorage Connector is attached to.

Prior to installation and use of this equipment, record the product identification information from the label in the Inspection and Maintenance Log at the end of this manual. Use a pen or fine point sharpie with blue or black ink when logging inspections.

SYSTEM SPECIFICATIONS:	
USER CAPACITY:	1 Person with a combined weight (clothing, tools, etc.) of no more than: 310 lbs for ANSI, 420 lbs for OSHA.
SERVICE TEMPERATURE:	-30°F to +130°F Minimum Service Temperatures.
BREAKING STRENGTH:	5,000 lbs Minimum Breaking Strength.
MATERIAL:	Hex Bar: Aluminum Alloy Jaws: Aluminum Alloy D-ring Assembly: Alloy Steel

Purpose: The Frontline Fall Arrest Anchors are designed to be used as a component in a Personal Fall Arrest System (PFAS) Frontline Fall Arrest Anchors are tested to meet or exceed applicable OSHA and ANSI standards so employees can work safely tie-off while maintaining mobility and being productive when using Anchorage Connector.

Approved Applications: Below are applications for which all Frontline Fall Arrest Anchors are best used in. This list is not all-inclusive but is intended to define the most common applications in which this product may be used:

APPROVED APPLICATIONS CHART

APPLICATION	DESCRIPTION	APPROVED APPLICATION
PERSONAL FALL ARREST	Person fall arrest is when the application where the user can be subject to a fall. The anchorage needs to be used in conjunction with approved connecting device such as a lanyard or self-retracting lifeline and a harness. Maximum permissible free fall is 6 ft (1.8 m). Anchorages selected for fall arrest systems shall be able to sustaining static loads applied in the directions permitted by the system of at least 5,000 lbs (23 kN) for non-certified anchorages or two times the maximum arresting force for certified anchorages.	X
RESTRAINT	Restraint is the application used by the user where the user is limited in distance so they cannot reach or be exposed to a fall hazard. Restraint systems shall have the strength capable of sustaining static loads applied to all directions permitted by the system and; No less than 1,000 lbs for non-certified field anchorages and two times the foreseeable force for certified anchorages or as determined by ANSI/ASSE Z359.6. This system also is composed of the anchorage, connecting device such as a lanyard or self-retracting lifeline and a harness.	X
WORK POSITIONING	Positioning devices shall be secured to an anchorage capable of supporting at least twice the potential impact load of an employee's fall or 3,000 pounds (13.3 kN), whichever is greater. This system also is composed of the anchorage, connecting device such as a lanyard or self-retracting lifeline and a harness.	X

SYSTEM REQUIREMENTS

Compatible Connectors: In order to use Frontline Fall Protection Anchors, connecting devices must include a compatible connector.

Compatible connectors must be approved snaphooks or carabiner which meet OSHA and ANSI standards to be compatible with the member to which they are connected to prevent unintentional disengagement. Snaphooks or carabiners shall be of locking type designed and used to prevent disengagement of the snaphook by the contact of the snaphook keeper by the connected member.

Structural Requirement: It is the requirement of the installer and user of the equipment that the substrate where the anchor is being installed can withstand a minimum breaking strength of 5,000 lbs per person or as part of a complete personal fall arrest system which maintains a safety factor of at least two; and under the supervision of a qualified person.

Making connections: When making the anchor connecting device connection, ensure that the connecting equipment is compatible and meets or exceeds OSHA and ANSI standards. Once connected, visually inspect the connection and perform a pull test to ensure that the equipment is locked and fully functioning. If equipment is not working properly or the safety integrity is in question, do NOT use and consult with Qualified Person. No more than one PFAS may be connected to a Fall Arrest Anchor at one time.

Ensure all connections are compatible in size, shape and strength. Do not use equipment that is not compatible. Ensure all connectors are fully closed and locked and that there's only one connection point per anchor per person. Perform a few pull tests to verify that the connection has been effective.

Frontline connectors (snaphooks and carabiners) are designed to be used only as specified in each product's user's instructions. See figure 2 for examples of inappropriate connections.

FIGURE 2 - NON-COMPATIBLE CONNECTIONS

1.



DO NOT connect two snaphooks or carabiners to each other.

2.



DO NOT connect two snaphooks or carabiners to a single D-ring at the same time.

3.



DO NOT connect in a way that would create a loading on the gate.

4.



DO NOT attach to an object in a manner whereby the gate of the snap hook or carabiner would be prevented from fully locking. Always visibly inspect for proper and full closure of the snap hook or carabiner.

5.



DO NOT attach directly back into the component itself such as webbing, cable, or rope, unless specifically allowed by manufacturer and instructions.

6.



DO NOT attach in a manner where the connector, gate or release lever, may become caught on the anchor causing additional risk of false connection.

7.



DO NOT attach a double snap hook to two side/ positioning D-rings in a manner whereby the D-rings will engage the gates.

NOTE: Large snap hooks must not be connected to objects which will result in a load on the gate if the hook twists or rotates, unless the snap hook complies with ANSI Z359.1-2007 or ANSI Z359.12 and is equipped with a 3,600 lb (16 kN) gate. Check the marking on your snap hook to verify its compatibility.

Personal Fall Arrest System: All PFAS used with this equipment must meet OSHA and ANSI Z359 requirements. A full body harness along with a compliant connecting device must be worn when this equipment is used as a component of a PFAS. As required by OSHA, the PFAS must be able to arrest the user's fall with a maximum arresting force of 1,800 lbs (8 kN), and limit the free fall to 6 ft (1.8 m). Once equipment is subject to a fall or an impact, equipment must be removed from service.

Structure Mounting Strength: The structure and mounting hardware must be capable of withstanding at least 5,000 pounds (22.2 kN) per employee attached. Installations MUST comply with all Federal, State, and local regulation standards and be approved by a Qualified Person before use.

Structure Mounting Selection: When selecting a mounting structure, there are various factors to be considered. Some which are described below, but not all inclusive:

- Select a structural component that can withstand a minimum breaking strength of 5,000 lbs.
- Select a work area, that will be free of obstructions.
- Select a work area, that will be free of any other recognizable safety hazards.
- Select an overhead anchor when possible. If overhead anchor is not possible, ensure that all the equipment used to connect the anchor is rated for below the waist tie-off.
- Ensure there are no swing hazards.

If the user is unable to determine whether the anchorage meets the manufacturer's specification, please contact Frontline at info@frontlinefall.com

Before Working with your PFAS: It is required that before using PFAS, a fall protection plan should be in place and used including the working conditions and equipment to be used. Here are some aspects, but not all inclusive, of the items that need to be included in a fall protection plan:

- End user training on the safe use, care and maintenance of equipment and jobsite conditions prior to commencing work.

- Inspection procedures.
- Fall clearances and potential swing falls.
- Proper structure/substrate anchoring to withstand the minimum required loads.
- A rescue plan in case end user or someone is subject to a fall.

Total Fall Clearance for PFAS: According to OSHA, the total fall clearance distance is the minimum vertical distance between the worker and the lower level that is necessary to ensure the worker does not contact a lower level during a fall. The total fall clearance distance is calculated before a decision is made to use a PFAS. If the available distance is not greater than the total fall clearance distance, it is inappropriate to use the PFAS and a fall restraint system might be used instead. Total fall clearance distance calculations are simple to perform based on several factors, including but not all inclusive:

- Lanyard/Self Retracting Lifeline length which may vary depending on the device being used and their specifications. See connecting device user manual for more information.
- The height at which the lanyard is anchored relative to where the other end attaches to the worker's harness.
- The distance the worker will travel as the deceleration device absorbs the energy from the fall (i.e., slows it down.)
- The worker's height.
- D-ring shift and a safety factor.

Below are illustrations to help guide the user to determine minimum fall clearances and swing hazards:

FIGURE 3

- A)** Connecting Subsystem (Energy Absorbing Lanyard Shown)
- B)** Working Level Shown
- C)** Lower Level or Obstruction
- D)** Free Fall - 6ft. (1.8m) Max. (per ANSI Z 359.11)
- E)** Deceleration Distance
- F)** Total Fall Distance Free Fall (D) + Deceleration (E)

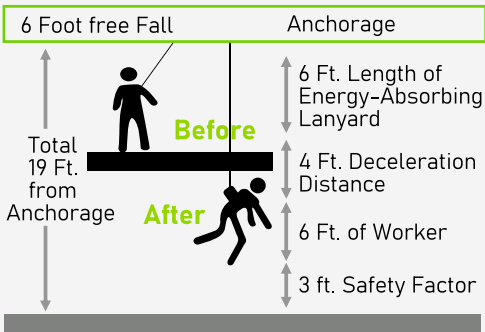
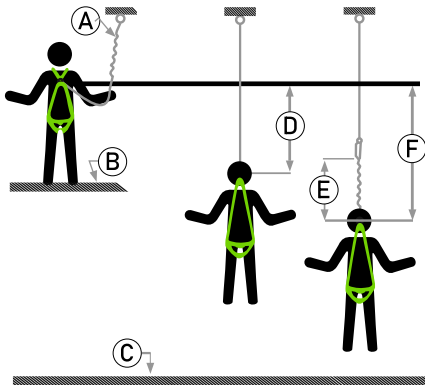

Free Fall Distance + Energy-Absorber Deceleration Distance + Worker height + Safety Factor = 19 Ft. (5.8M)

Swing Fall: The swing fall hazard is created by the pendulum effect, which can swing a fallen worker into a nearby surface, such as a wall or protruding beam. In addition to calculating the total fall clearance distance before beginning work on an elevated level, it is important to evaluate the swing fall hazard at the edges where a worker might fall.

A worker who falls while connected to an anchor (unless it is directly overhead) will swing back and forth like a pendulum. Workers can be seriously injured if they strike objects during a swing fall. Installing the anchorage point directly above the work area (i.e., connected to an overhead attachment point with sufficient strength) will help prevent injury.

FIGURE 4

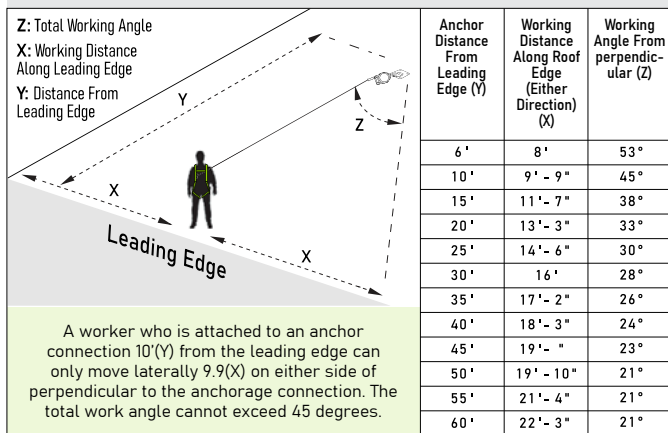

INSPECTION REQUIREMENTS

This anchor and any other PFAS shall be inspected BEFORE each use. The authorized user or rescuer inspecting the product shall have the proper training on the use, maintenance, care and inspection of this product. Additionally, a competent or qualified person other than the user shall conduct thorough safety inspections every 6 months or sooner, when necessary or required by the authorized user or employer. Some of the items that shall be inspected, but not all inclusive, are the following:

- Safety labels/markings/tags that are legible with appropriate OSHA/ANSI markings, product limitations, user capacity and other markings as required by OSHA/ANSI.
- Defects or any imperfections on the products such as; Corrosion, broken, bent, deformed, excessive wear, defects in welded areas or any other evidence of damage or alterations affecting the safety functionality of the anchor.
- Any other conditions that may question the integrity of the anchor, shall be put out of service.
- Any product that has been subject to a fall or an impact, shall be put out of service.
- Clean/clear product of any surface contamination such as concrete, stucco, roofing material or other material that may impact the safe use of the product.

These are minimum requirements, and all inspections should be documented for recordkeeping. Any questions regarding the safety inspection of Frontline Fall Protection products please contact us at info@frontlinefall.com.

INSTALLATION

When installing the beam anchor onto structural steel or I-Beams, Frontline requires that I-Beam has a minimum flange width of 3.5" and maximum of 12" or 18" depending on the beam anchor being used and an overall thickness of ½" – 1". The substrate also must withstand the required 5,000 lbs minimum breaking strength and approved before use by a qualified person. Thereafter, then follow the next steps:

1. Make sure that the I-beam is clear of obstructions and that the I-beam is fully installed and part of the structure.
2. Ideally the beam anchor would be preferred to be used in overhead applications, if foot level tie-off is required other connecting devices need to be suitable for the application.
3. Only use the beam anchor on horizontal I-Beam applications, not vertical applications.
4. Once the desired I-beam anchoring location is determined, then loosen both the outer and inner retainer nuts adjacent to opening the beam anchor, creating an opening large enough to allow the beam flange to fit between the beam clamps as shown on figure 5.

FIGURE 5

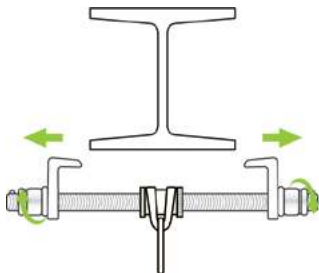

**TO OPEN BEAM CLAMPS TURN
LOCKING NUTS COUNTERCLOCKWISE**

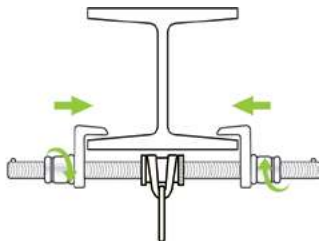

**TO CLOSE BEAM CLAMPS AND
SECURE BEAM ANCHOR TURN
LOCKING NUTS CLOCKWISE**

5. Position the clamps over the beam flange. Then, close the clamps so that the clamps are over the beam flange and turn locking nuts clockwise in order to secure the anchor. The beam clamps must be closed symmetrically on the beam as shown on figure 6.

FIGURE 6

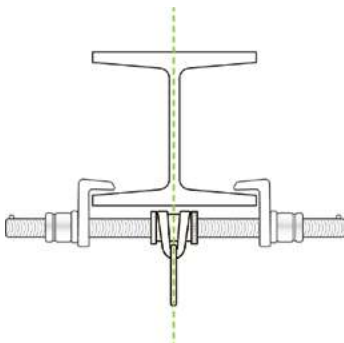

6. Check stability of the connection and that the anchor is installed correctly and there is no possibility of self-acting disconnection the beam anchor from the I-Beam.
7. Check that the ends of the I-beam are enclosed so that there is no possibility of the beam anchor sliding out from I-beam as shown on figure 7.

FIGURE 7

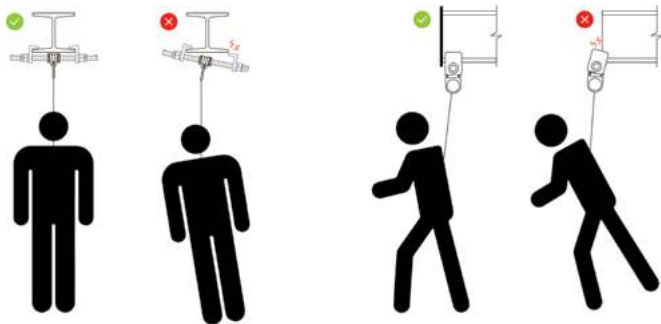

8. Once correctly installed and inspected, anchor is ready for use with the compatible additional PFAS.
9. To remove the anchor from I-Beam, ensure that employee/user is properly tied-off and protected before removing anchor. After, turn the locking nuts counterclockwise to open the clamps and remove the anchor from the I-Beam.

DIRECTION LOADING

Anchor can be installed on structural steel working surfaces, specifically I-Beams for overhead installation and applications. The anchor must be installed with the d-ring positioned downwards facing the user at an angle no more than 40 degrees as shown on figure 8.

Under no circumstances can the anchor be subject to side loading. Refer to anchor positioning chart for applications of lower than 40 degrees working angles for the different allowable distances and angles to reduce swing falls.

FIGURE 8

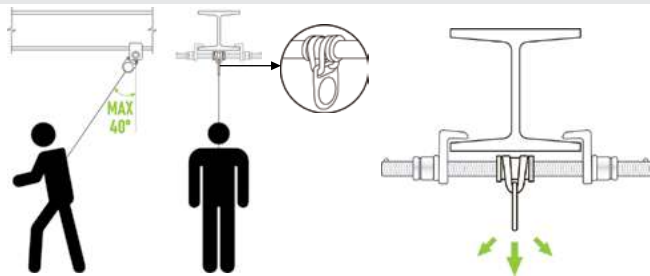

MAINTENANCE, SERVICE, AND STORAGE

MAINTENANCE AND SERVICE: Repairs and maintenance can only be done by Frontline Fall Protection. No company or end user shall maintain or repair Frontline Fall Protection products under no circumstances. Product that does not pass inspection or is questionable needs to be taken out of service immediately and then notified to Frontline Fall Protection for inspection and further action.

STORAGE AND CLEANING: If products are not temporarily or permanently installed, when possible, all products shall be stored at room temperature in indoor space, lockers or in a clean area away from sunlight, rain and other environmental conditions. Products should be also stored where they are not exposed to chemical, oils, paint, concrete, or other contaminants that might compromise the integrity of the product. Equipment that has been physically exposed such as rain/dirty water, concrete, paint, buildup of other construction material or other surface contamination shall be cleaned and dried before storage. Equipment chemically exposed that cannot be cleaned with water and soap needs to be removed from service.

TRANSPORT: Ensure to transport product where it doesn't beat up against other products as this might cause damage to products and terminate the use of them. Product also should not be transported with harmful substances or chemicals as this might also compromise the integrity of the product.

INSPECTION AND MAINTENANCE LOG

INSPECTION DATE:		INSPECTED BY:	
COMPONENTS:	Inspection: Prior to installation and prior to each use / Inspection by a competent person is required every 6 months.	PASS	FAIL
ANCHORAGE:	Inspect the Anchor and D-ring for damage: Look for cracks, dents, or deformities.	<input type="checkbox"/>	<input type="checkbox"/>
	Inspect for permanent deformation.	<input type="checkbox"/>	<input type="checkbox"/>
	Inspect the entire unit for corrosion.	<input type="checkbox"/>	<input type="checkbox"/>
	Inspect for any other unconformity.	<input type="checkbox"/>	<input type="checkbox"/>
	Nylon bushing is in place and secure	<input type="checkbox"/>	<input type="checkbox"/>
	Inspect that all locking nuts are turning and locking properly	<input type="checkbox"/>	<input type="checkbox"/>
	Inspect that safety pins are in place and secured on both sides	<input type="checkbox"/>	<input type="checkbox"/>
	Other.	<input type="checkbox"/>	<input type="checkbox"/>
LABELS	Inspect the Anchor for illegible safety markings.	<input type="checkbox"/>	<input type="checkbox"/>
PFAS AND OTHER EQUIPMENT	Additional Personal Fall Arrest System (PFAS) equipment (harness, SRL, etc) that are used with the Anchorage System should be installed and inspected per the manufacturer's instructions.	<input type="checkbox"/>	<input type="checkbox"/>

INSPECTION DATE:	INSPECTED BY:
MODEL NUMBER:	DATE OF FIRST USE:
Corrective Action/Maintenance:	Approved by:
	Date:
Corrective Action/Maintenance:	Approved by:
	Date:
Corrective Action/Maintenance:	Approved by:
	Date:
Corrective Action/Maintenance:	Approved by:
	Date:
Corrective Action/Maintenance:	Approved by:
	Date:

SAFETY MARKINGS





Frontline Fall Protection Inc.

www.frontlinefall.com

info@frontlinefall.com

©2023 Frontline