

FRONTLINE

FALL PROTECTION

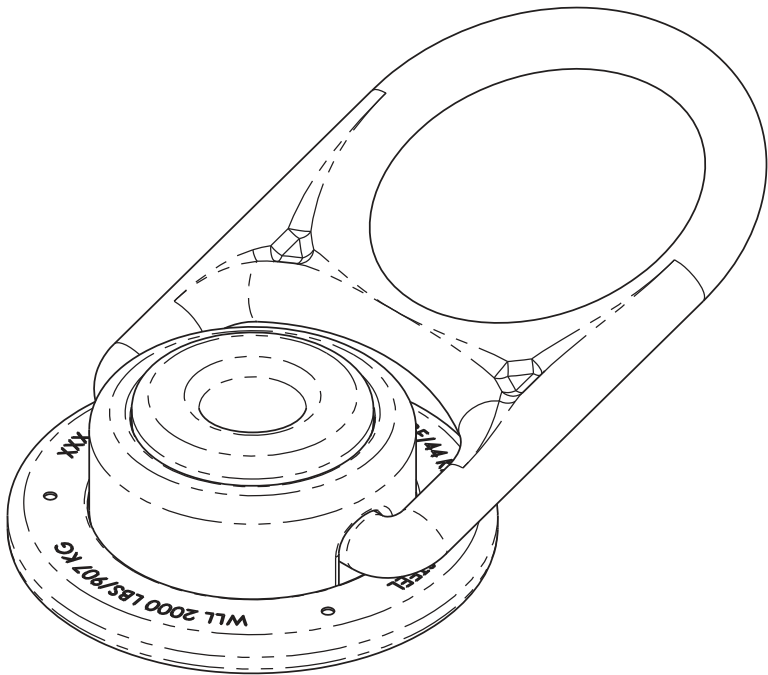

OPERATION AND INSTRUCTION MANUAL

Swivel Anchor Model: COM3410K and STM5810K



WARNING: ALL PERSONS USING THIS EQUIPMENT MUST READ AND UNDERSTAND ALL INSTRUCTIONS. FAILURE TO DO SO MAY RESULT IN SERIOUS INJURY OR DEATH. USERS SHOULD BE FAMILIAR WITH PERTINENT REGULATIONS GOVERNING THIS EQUIPMENT. ALL INDIVIDUALS WHO USE THIS PRODUCT MUST BE PROPERLY INSTRUCTED ON HOW TO USE THE DEVICE. AVOID CONTACT WITH PHYSICAL HAZARDS (THERMAL, CHEMICAL, ELECTRICAL, ETC.). MAKE ONLY COMPATIBLE CONNECTIONS.

Read This Instruction Manual Carefully Before Using This Equipment.

User Instructions must always be available to the user and are not to be removed except by the user of this equipment. For proper use, see supervisor, User Instructions, or contact the manufacturer.



Compliant fall protection and emergency rescue systems help prevent serious injury during fall arrest. Users and purchasers of this equipment must read and understand the User Instructions provided for correct use and care of this product. All users of this equipment must understand the instructions, operation, limitations and consequences of improper use of this equipment and be properly trained prior to use per OSHA 29 CFR 1910.66 and 1926.503 or applicable local standards.

Misuse or failure to follow warnings and instructions may result in serious personal injury or death.

PURPOSE

The COM3410K and STM5810K are anchorage connectors designed to function as an interface between the anchorage and a fall protection, work positioning, rope access, or rescue system for the purpose of coupling the system to the anchorage. Any references to "anchorage connector" in this manual include, and apply to, the COM3410K and STM5810K.

USE INSTRUCTIONS

1. A user must be of sound mind and body to properly and safely use this equipment in normal and emergency situations. Users must have a physician ensure they are clear of any medical conditions that may affect the proper and safe use of this equipment in normal and emergency situations.
2. Before using a personal fall arrest system, user must be trained in accordance with the requirements of OSHA 29 CFR 1910.66 in the safe use of the system and its components.
3. Use only with ANSI/OSHA compliant personal fall arrest or restraint systems. The anchorage must have the strength capable of supporting a static load, applied in the directions permitted by the system, of at least 10,000-lbf (44kN) in the absence of certification.
4. The user shall be equipped with a means of limiting the maximum dynamic forces exerted on the user during the arrest of a fall to a maximum of 8 kN (1800-lbf). In the EU these forces must be limited to 6 kN (1350-lbf).
5. Use of this product must be approved by an engineer or other qualified person to be compatible with any and all structural & operational characteristics of the selected installation location and system to be connected to this anchorage connector.
6. The anchorage connector must be inspected prior to each use for wear, damage, and other deterioration. If defective components are found the anchorage connector must be immediately removed from service in accordance with the requirements of OSHA 29 CFR 1910.66 and 1926.502.
7. The anchorage connector should be positioned in such a way that minimizes the potential for falls and the potential fall distance during use. The complete fall protection system must be planned (including all components, calculating fall clearance, and swing fall) before using.
8. A rescue plan, and the means at hand to implement it, must be in place that provides the prompt rescue of users in the event of a fall, or assures that users are able to rescue themselves.
9. After a fall occurs the anchorage connector must be removed from service and destroyed immediately.

USE LIMITATIONS: The anchorage connector shall not be used outside its limitations, or for any purpose other than that for which it is intended.

1. The anchorage connector is designed for single user, with a capacity up to 310 lbs (140 kg) including clothing, tools, etc.
2. The anchorage connector may only be loaded in acceptable directions shown in the LOADING CONDITIONS DIAGRAM.
3. The anchorage connector is designed to be used in temperatures ranging from -40°F to +130°F (-40°C to +54°C).
4. Do not expose the anchorage connector to chemicals or harsh solutions which may have a harmful effect.
5. Do not alter or modify this product in any way.
6. Caution must be taken when using any component of a fall protection, work positioning, rope access, or rescue system near moving machinery, electrical hazards, sharp edges, or abrasive surfaces, as contact may cause equipment failure, personal injury, or death.
7. Do not use/install equipment without proper training by a "competent person" as defined by OSHA 29 CFR 1926.32(f).
8. Do not remove the labeling from this product.
9. Additional requirements and limitations may apply depending on anchorage type and fastening option utilized for installation. All placements must be approved by an engineer or other qualified person.
10. This anchorage connector should not be used as part of a horizontal lifeline system that has not been designed and or approved to be used with 10,000-lbf anchorage connectors.
11. The anchorage connector should only be used for personal fall protection and not for lifting equipment.

COMPATIBILITY LIMITATIONS

Anchorage connector must only be coupled to compatible connectors. OSHA 29 CFR 1926.502 prohibits snaphooks from being engaged to certain objects unless two requirements are met: it must be a locking type snaphook, and it must be "designed for" making such a connection. "Designed for" means that the manufacturer of the snaphook specifically designed the snaphook to be used to connect to the equipment listed. The following connections must be avoided, because they can result in rollout* when a nonlocking snaphook is used:

- Direct connection of a snaphook to horizontal lifeline.
- Two (or more) snaphooks connected to one D-ring.
- Two snaphooks connected to each other.
- A snaphook connected back on its integral lanyard.
- A snaphook connected to a webbing loop or webbing lanyard.
- Improper dimensions of the D-ring, rebar, or other connection point in relation to the snaphook dimensions that would allow the snaphook keeper to be depressed by a turning motion of the snaphook.

***Rollout: A process by which a snaphook or carabiner unintentionally disengages from another connector or object to which it is coupled. (ANSI Z359.0-2007)**

LABEL LOCATIONS

10K Swivel Anchor
Zinc Plated Steel
Max Capacity:
(1) person 310-lbs

FRONTLINE
FALL PROTECTION
Model: COM3410K
www.frontlinefall.com

WARNING: All persons using this equipment must read, understand and follow all instructions. Failure to do so may result in serious injury or death. **(INSPECT BEFORE USE)**
COMPLIANCE: OSHA 1910.66, OSHA 1926.502, ANSI Z359.18 Type A, ANSI Z359.7(11)

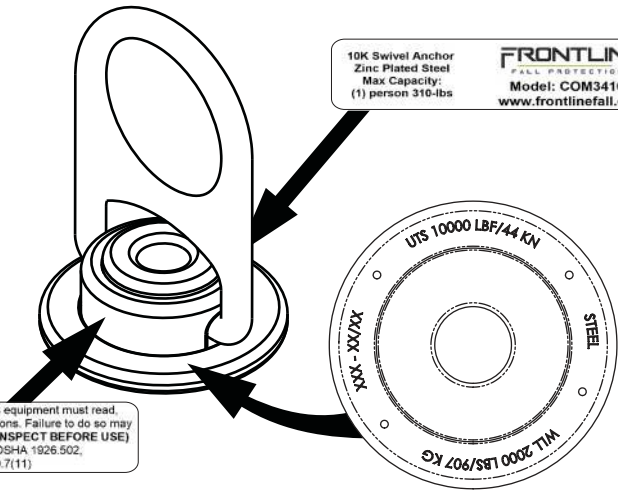

8"Ø
(203.2mm)

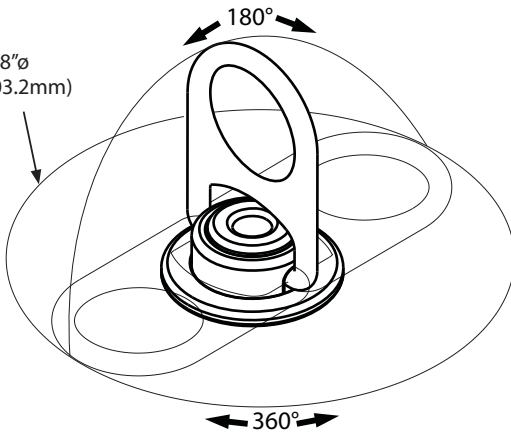

5.5"
(139.7mm)

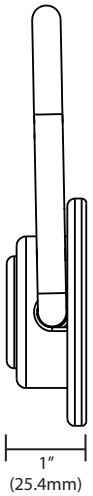
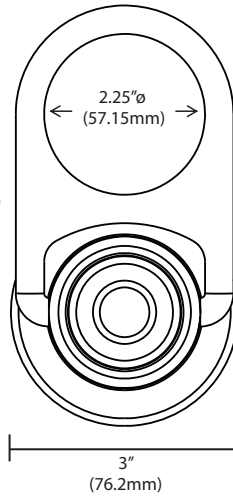

Tensile Strength (UTS): 10,000-lbf (44kN)

Working Load: 2,000-lbs (907kg)

Weight: 1.2-lbs (544.3g)

Materials: Zinc Plated Steel

Regulatory Compliance: Meets or exceeds ANSI Z359.18 Type A, ANSI Z359.7-2011 OSHA 1926.502

LOADING CONDITIONS DIAGRAM

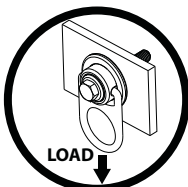

ACCEPTABLE

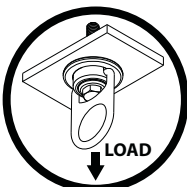

ACCEPTABLE

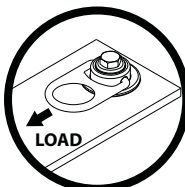

ACCEPTABLE

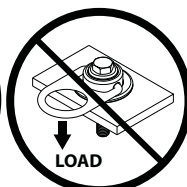

IMPROPER

STEEL MOUNTING

1. Use a proper drill and bit for steel.
2. Drill a 5/8" (16mm) hole no less than .75" (6mm) deep 3" (76mm) away from any edge.
3. Hole must be straight and perpendicular to surface.
4. Hole must be free of debris.

5/8"-11
Lock Nut



5/8" Lock
Washer



5/8"-11x4"
Hex Bolt *

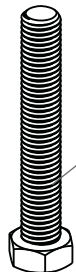

Torque Range:
75 to 90 ft-lbs
(100-120Nm)

* Use tapered washer with I-beams
that have tapered flanges.

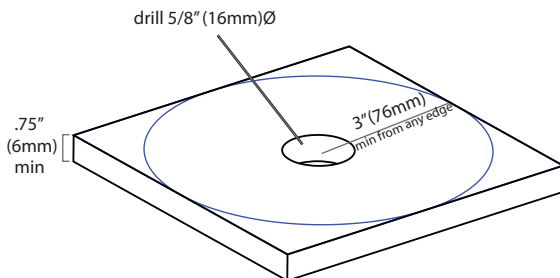
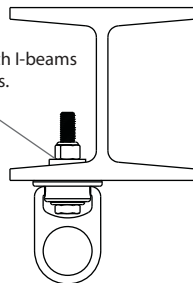

* For steel applications a grade 5, grade 8 (or equivalent) bolt no shorter than 4" (100mm) with a locking nut and washer must be used. Swivel anchor must be flush with steel surface. A 16mm bolt of equal strength may be used in place of a 5/8"-11 for metric applications.

CONCRETE MOUNTING

1. Use a proper drill and bit for concrete (SDS drill bit).
2. Drill a .75" (19mm) hole no less than 5" (114mm) deep 9" (229mm) away from any edge.
3. Hole must be straight & perpendicular to surface.
4. Hole must be free of debris
5. Concrete strength must be at least 3000psi (20.7MPa) and no less than 7" (178mm) thick.

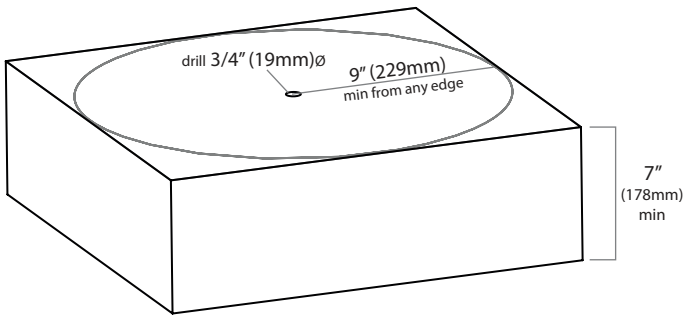

Torque:
110 ft-lbs (149Nm)

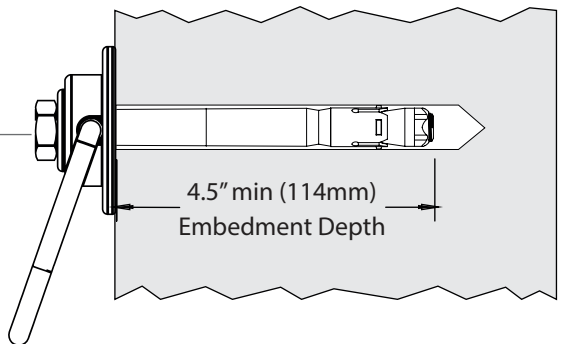

WELD ON MOUNTING

Grade - 5 or 8 bolt
5/8"-11 x 1-3/4"

Torque Range:
75 to 90 ft-lbs
(100-120Nm)

Weld Puck
(AISI 1018)

3/8" min
(9.5mm)

Internal Tooth Lock Washer

* Weld

* Welding procedure must be approved by an engineer or other qualified person to be compatible with any and all structural & operational characteristics of the selected installation location.

BACK PLATE MOUNTING

Back Plate to be used with 5/8" (16mm) bolts or all thread. Drill hole perpendicular into surface so bolt can pass freely through the substrate. Nut must be fully threaded on the bolt to insure maximum strength ratings and integrity of anchor.

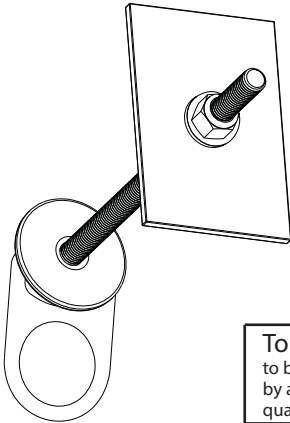

Torque Range:
to be determined
by an engineer or
qualified person.

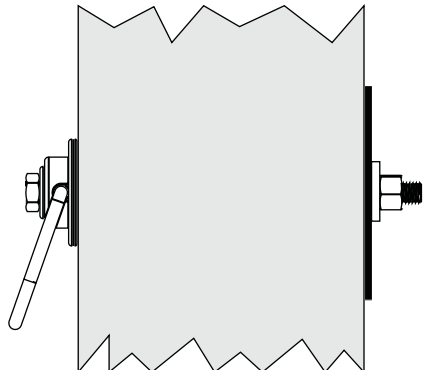

* Bolt or All-thread and nut not included with Back Plate.

STRAIGHT LOOP INSERT

See Straight Loop Insert Manual for anchorage casting instructions.

1. Strip decking to expose the Straight Loop Insert.
2. Ensure that anchorage was properly installed. Orange indicator should be flush with concrete surface, and at least 9" from any edge or corner. Concrete should be at least 6" thick and cured to a minimum of 3000 psi.
3. Remove plastic bolt and o-ring using 1/2" allen wrench.
4. Save plastic bolt and o-ring to re-insert into Straight Loop Insert when not in use.
5. Insert bolt and washer through Mega Swivel and into the threaded hole of the Straight Loop Insert.
6. To fasten Mega Swivel, tighten bolt* to 70-80 ft-lbs using torque wrench.

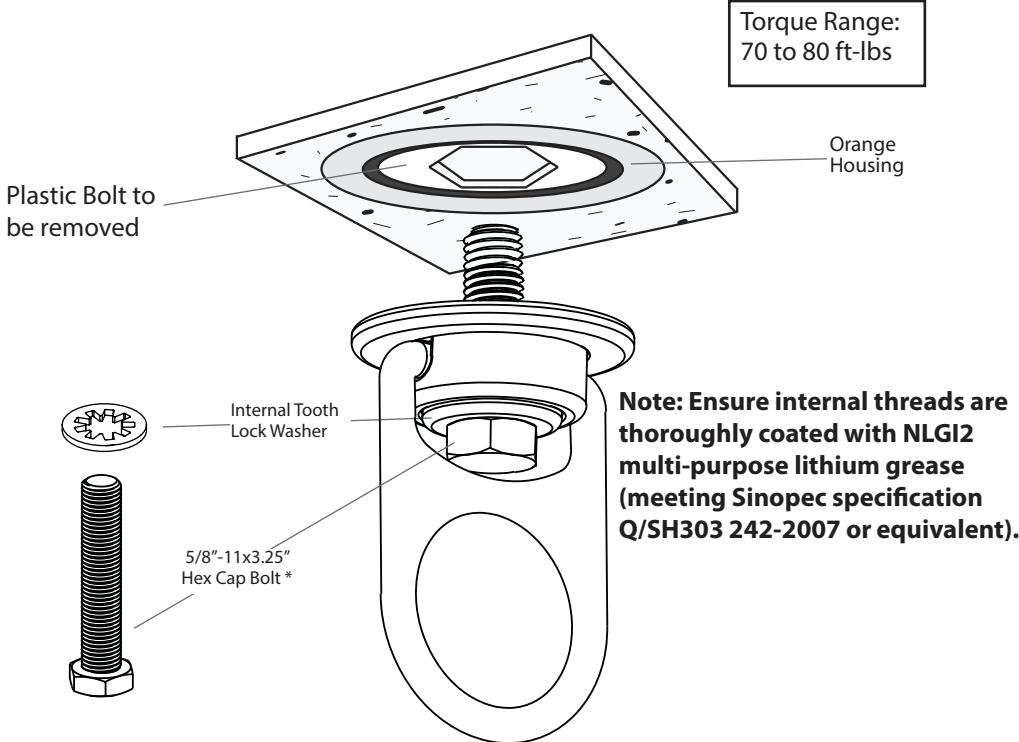

WARNING: Do not install if insert was knocked over during installation. Mega Swivel must mount flush to surface when fastened with the proper torque.

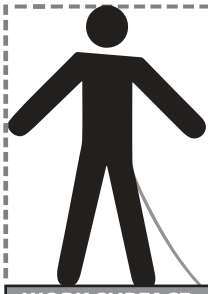

WORK SURFACE

*The user shall be equipped with a means of limiting the maximum dynamic forces exerted on the user during the arrest of a fall to a maximum of 8 kN (1800-lbf). In the EU these forces must be limited to 6 kN (1350-lbf).



(ANCHOR POINT)

*The structure the anchorage is attached to must be able to support 10,000-lbf (44kN) and installed under the supervision of a qualified person.



WORK SURFACE

****All products subjected to fall arresting forces should be removed from service immediately!***

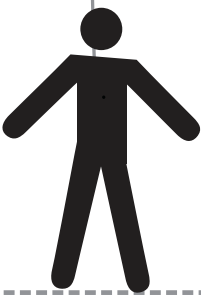

MINIMUM CLEARANCE 3ft (1m)

DECK/FLOOR/GROUND LEVEL

WARNING!!! SWING FALLS MAY OCCUR WHEN THE WORKER IS NOT DIRECTLY UNDER ANCHOR POINT.

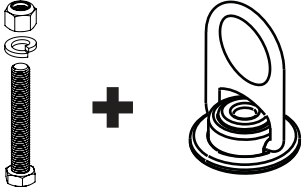
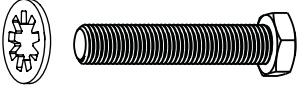
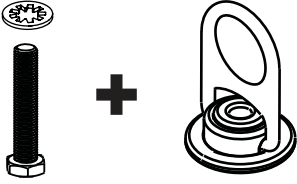
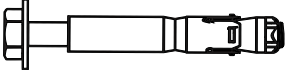
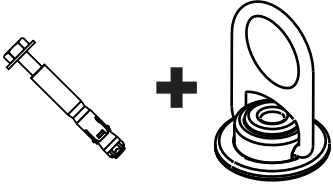
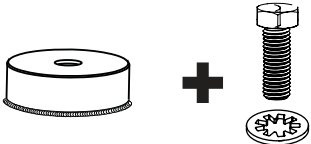
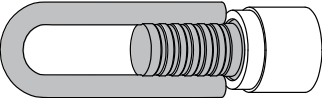
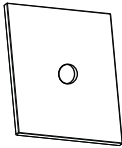
	KIT CONTENTS	PART NUMBER
METAL		STM5810KRB (Steel Mounting Hardware Kit)
		STM5810K (Swivel with Steel Mounting kit)
CONCRETE		Call for more info. (Straight Loop Insert Mounting Kit)
		Call for more info. (Swivel with Straight Loop Insert Mounting kit)
		COM3410KRB (Concrete Hardware Kit)
		COM3410K (Swivel with Concrete Mounting Kit)
ACCESSORIES		Call for more info. (Weld-on Mounting Kit)
		Call for more info. (Straight Loop Insert)
		Call for more info. (Backing Plate Only)

MAINTENANCE, CLEANING AND STORAGE

Cleaning periodically will prolong the life and proper functioning of the product. The frequency of cleaning should be determined by inspection and by severity of the environment. Clean with compressed air and/or a stiff brush using plain water or a mild soap and water solution. Do not use any corrosive chemicals that could damage the product. Wipe all surfaces with a clean, dry cloth and hang to dry, or use compressed air. When not in use, store anchorage connectors in a cool, dry, clean environment, out of direct sunlight and free of corrosive or other degrading elements.

INSPECTION AND MAINTENANCE LOG

MODEL NUMBER: _____

DATE OF MANUFACTURE: _____

Date	Part Number	Comments	Inspector Name

Inspection:

Official periodic inspection must be made at least semiannually. The inspection must be performed by a qualified person other than the intended user. If severe weather or conditions exist then inspections must be carried out more frequently. All inspection results must be logged in the space provided above.

1. Inspect swivel to make sure it is flush with mounting surface.
2. Make sure all labeling is affixed to the unit.
3. Make sure the unit can rotate 360° and D-ring can flip from side to side.
4. When reusing a previously drilled hole, inspect for debris or wallowing.
5. Record inspection results in the space provide above.

***If any damage that could affect the strength or operation of the device, or unsafe conditions are found, proper disposal is required. The anchorage connector must be rendered unusable and then properly discarded.**

Product Warranty, Limited Remedy and Limitation of Liability

WARRANTY: THE FOLLOWING IS MADE IN LIEU OF ALL WARRANTIES OR CONDITIONS, EXPRESS OR IMPLIED, INCLUDING THE IMPLIED WARRANTIES OR CONDITIONS OF MERCHANTABILITY OR FITNESS FOR A PARTICULAR PURPOSE. Equipment offered by Frontline Fall Protection is warranted against factory defects in workmanship and materials for a period of one year from date of purchase or first use by the original owner.

LIMITED REMEDY: Upon notice in writing, Frontline Fall Protection will repair or replace all defective items at Frontline Fall Protection's sole discretion. Frontline Fall Protection reserves the right to require that the defective item be returned to its plant for inspection before determining the appropriate course of action. Warranty does not cover equipment damage resulting from wear, abuse, damage in transit, failure to maintain the product or other damage beyond the control of Frontline Fall Protection. Frontline Fall Protection shall be the sole judge of product condition and warranty options. This warranty applies only to original purchaser and is the only warranty applicable to this product. Please contact Frontline Fall Protection technical service department for assistance.

LIMITATION OF LIABILITY: IN NO EVENT WILL FRONTLINE FALL PROTECTION BE LIABLE FOR ANY INDIRECT, INCIDENTAL, SPECIAL OR CONSEQUENTIAL DAMAGES INCLUDING, BUT NOT LIMITED TO LOSS OF PROFITS, IN ANY WAY RELATED TO THE PRODUCTS REGARDLESS OF THE LEGAL THEORY ASSERTED.

Frontline Fall Protection
2023 NW 84th AVE
Miami, FL 33122
info@frontlinefall.com / www.frontlinefall.com