

FRONTLINE

FALL PROTECTION

USER INSTRUCTION MANUAL

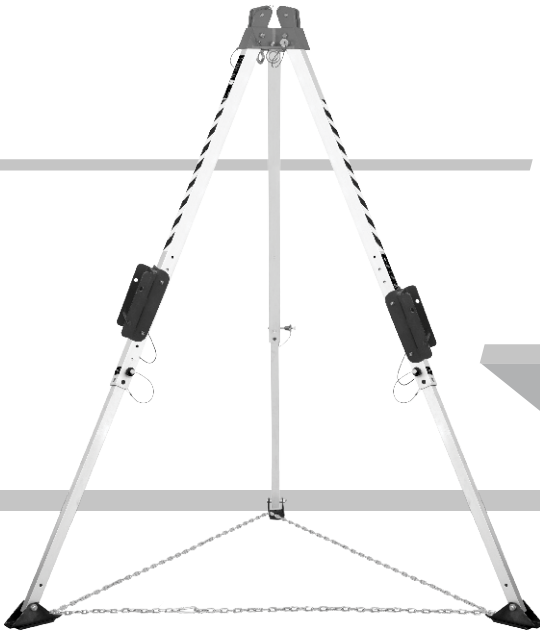

MEGAPOD

**This instruction manual
applies to the following models:**

TAN07, TAN10



ANSI Z359.1-2007

Do not skip this instruction manual. Read the instruction manual carefully before using the equipment. If failed in doing so it may cause serious Injury or Death.

Note: The user is advised to keep the user instructions document for the life of the product.

| | | |
|---------------------------|---|--|
| Manufacturer | : | www.frontlinefall.com |
| Certification Body | : | SATRA Technology Centre, Wyndham Way, Telford Way, Kettering, NN16 8SD, UK (Notified Body 0321) |

This manual must be read and understood in its entirety and used as part of fall protection training program as required by OSHA or any state regularity agency. These instructions are intended to meet the manufacturer instructions as required by ANSI Z 359.1-2007 and OSHA . The user must fully understand the proper equipment use and limitations.



- 1. GENERAL REQUIREMENTS, WARNINGS AND LIMITATIONS:** The Equipment is designed for use as a part of a personal fall protection system. Components must not be used for any other operation other than that which it has been designed and approved. Fall Arrest system are designed to comply with OSHA. Fall Restraint System must be designed by a Qualified Person, and must be installed and used under the supervision of a competent person.
 - All authorized persons/users must refer the regulations governing occupational safety, as well as applicable ANSI or CSA standards. Please refer to product labeling for information on specific OSHA regulations, and ANSI and CSA standards met by product.
 - Consult a doctor if there is any reason to doubt a user's ability to withstand and safely absorb fall arrest forces. Age, fitness, health conditions can seriously affect the worker a fall occur. Pregnant Women and minors should not use this equipment.
 - Proper precautions should always be taken to remove any obstructions, debris, material, or other recognized hazards from the work area that could cause injuries or interfere with the operation of the system. All equipment must be inspected before each use according to the manufacturer's instructions. All equipment should be inspected by a qualified person on a regular basis.
 - To minimize the potential for accidental disengagement, a competent person must ensure system compatibility.
 - Equipment must not be altered in any way. Repairs must be performed only by the Manufacturer, or persons or entities authorized in writing by the manufacturer.
 - Any product exhibiting deformities, unusual wear, or deterioration must be immediately discarded. Any equipment subject to a fall must be removed from service. The authorized person/user shall have a rescue plan and the means at hand to implement it when using this equipment.
 - Never use fall protection equipment for purposes other than those for which it was designed. Fall protection equipment should never be used for towing or hoisting.
 - All synthetic material must be protected from slag, hot sparks, open flames, or other heat sources. The use of heat resistant materials is recommended in these applications.
 - Never use natural materials (manila, cotton, etc.) as part of a fall protection system.
 - Do not expose this equipment to chemicals which may have a harmful effect on the materials used to construct it. Be especially aware of caustic environment, or those that contain high levels of organic acids or bases. If you are uncertain about the safe operation of this equipment in any environment, contact FRONTLINE for further instructions.
 - Do not use the equipment near sharp edges, abrasive surfaces and looping around small diameter structural members.
 - Do not use the equipment around moving machinery or electrical hazards.

FRONTLINE Megapod should be used only with the combinations of components, sub-systems or both which may affect or interfere with the safe function of one another. Be certain that connecting devices are compatible and that other elements of the PFAS are safe to use and compatible before use.

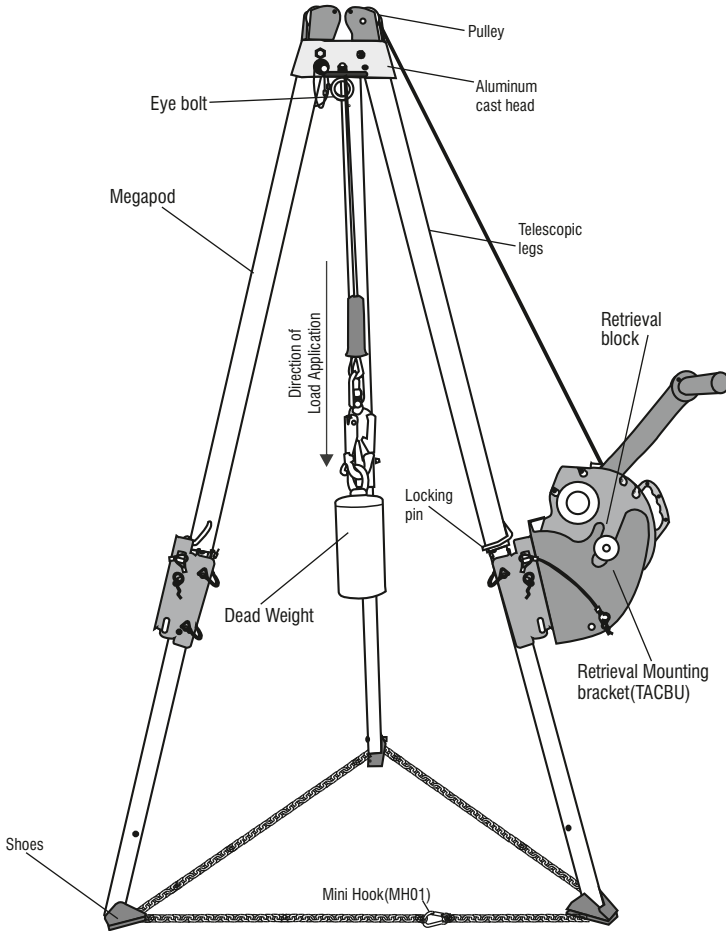
Product Over View



Brackets used with megapod variants-

| Ref. No. | SA 17(25) Sub 1 | SA 17(25) | TACBU |
|-----------------------------|---|---|---|
| Supplied with Megapod | Yes | No | No |
| Can be purchased separately | Yes | Yes | |
| Product |  <p>Part of standard Megapod</p> |  <p>Part of standard Megapod Winch</p> |  |

2. **SYSTEM LIMITATIONS & REQUIREMENTS:** Consider the following limitations/requirements prior to installing or using this equipment:

- **Capacity:** FRONTLINE Megapod is designed for use by ONE person with a combined weight (clothing, tools, etc.) of no more than 310 lbs. (140 kg) Make sure all of the components in your system are rated to a capacity appropriate to your application. FRONTLINE Megapod is rated 5000lbs.
- **Free Fall:** Personal fall arrest systems used with this equipment must be rigged to limit the free fall to 6 feet (1.8 M) per ANSI Z359.1. Restraint systems must be rigged so that no vertical free fall is possible. Work positioning systems must be rigged so that free fall is limited to 2 feet (.6 m) or less. Personnel riding systems must be rigged so that no vertical free fall is possible. Climbing systems must be rigged so that free fall is limited to 18 inch. (.46 cm) or less. Rescue systems must be rigged so that no vertical free fall is possible. See subsystem manufacturer's instructions for more information. Below figure illustrates fall clearance requirements. There must be sufficient clearance below the user to allow the system to arrest a fall before the user strikes the ground or other obstruction. Clearance required is dependent on the following factors:

- Elevation of Anchorage
- Connecting Subsystem Length
- Deceleration Distance
- Free Fall Distance
- Worker Height

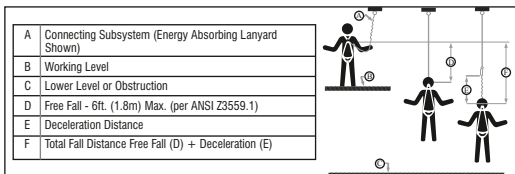

Movement of Harness Attachment Element

- **Swing Falls:** Swing falls occur when the anchorage point is not directly above the point where a fall occurs. The force of striking an object in a swing fall may cause serious injury or death. Minimize swing falls by working as close to the anchorage point as possible. Do not permit a swing fall if injury could occur. Swing falls will significantly increase the clearance required when a self-retracting lifeline or other variable length connecting subsystem is used.
- **Environmental Hazards:** Use of this equipment in areas with environmental hazards may require additional precautions to prevent injury to the user or damage to the equipment. Hazards may include, but are not limited to; heat, chemicals, corrosive environments, high voltage power lines, gases, moving machinery, and sharp edges.
- **Compatibility of Components:** Unless otherwise noted, FRONTLINE equipment is designed for use with FRONTLINE approved components and subsystems only. Substitutions or replacements made with non-approved components or subsystems may jeopardize compatibility of equipment and may affect safety and reliability of the complete system.
- **Compatibility of connectors:** Connectors are considered to be compatible with connecting elements when they have been designed to work together in such a way that their sizes and shapes do not cause their gate mechanisms to inadvertently open regardless of how they become oriented. If the connecting element that a snap hook or karabiner attaches to is undersized or irregular in shape, a situation could occur where the connecting element applies a force to the gate of the snap hook or karabiner. This force may cause the gate (of either a self-locking or a non-locking snap hook) to open, allowing the snap hook or karabiner to disengage from the connecting point. Connectors must be compatible in size, shape, and strength. Self-locking snap hooks and karabiners are required by ANSI Z359.1 and OSHA.
- **Making connections:** Always use snap hooks and karabiners which needs double manual action to open with this equipment. Only use connectors that are suitable to each application. Ensure all connections are compatible in size, shape and strength. Do not use equipment that is not compatible. Ensure all connectors are fully closed and locked. The connection should not be made-
 - To a D-ring to which another connector is attached.
 - In a manner that would result in a load on the gate.
 - In a false engagement, where features that protrude from the snap hook or karabiner catch on the anchor and without visual confirmation seems to be fully engaged to the anchor point.
 - To each other.
 - Directly to webbing or rope lanyard or tie-back (unless the manufacturer's instructions for both the lanyard and connector specifically allow such a connection).
 - To any object which is shaped or dimensioned such that the snap hook or karabiner will not close and lock, or that roll-out could occur.

NOTE: Other than 3,600 lb. (16 kN) gated hooks, large throat opening snap hooks should not be connected to standard size D-rings or similar objects which will result in a load on the gate if the hook or D-ring twists or rotates. Large throat snap hooks are designed for use on fixed structural elements such as rebar or cross members that are not shaped in a way that can capture the gate of the hook.

3. RESTRICTIONS REGARDING MAKING CONNECTIONS:

- Use connectors conforming to ANSI Z351.12.2009 to make connections.
- Do not make connections where the hook locking mechanism can come into contact with a structural member or other equipment and potentially release the hook.
- Do not connect a snap hook into a loop or thimble of a wire rope or attach in any way to a slack wire rope.
- The snap hook must be free to align with the applied load as intended (regardless of the size or shape of the mating connector)
- A karabiner may be used to connect to a single or pair of soft loops on a body support such as a body belt or full body harness, provided the karabiner can fully close and lock. This type of connection is not allowed for snap hooks.
- A karabiner may be connected to a loop or ring connector that is already occupied by an automatic closing connector.

Fig. 2 - Unintentional Disengagement (roll-out)

If the connecting element to which a snap hook (shown) or karabiner attached is undersized or irregular in shape, a situation could occur where the connecting element applies a force to the gate of the snap hook or karabiner. This force may cause the gate (of either a self-locking or a non-locking snap hook) to open, allowing the snap hook or karabiner to disengage from the connecting point.

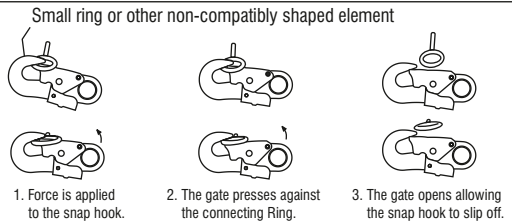

4. CONNECTING SUB-SYSTEMS: Personal fall arrest systems used with this equipment must meet applicable state, OSHA and ANSI requirements. A full body harness must be worn when this equipment is used as a component of a personal fall arrest system. As required by OSHA, the personal fall arrest system must be capable of arresting the user's fall with a maximum arresting force of 1,800 lbs. (8 kN), and limit the free fall to 6 ft. (1.8 m) or less. If the maximum free fall distance must be exceeded, the employer must document, based on test data, that the maximum arresting force will not be exceeded, and the personal fall arrest system will function properly. Free fall greater than 6 ft. (1.8 m), and up to a maximum of 12 ft. (3.7 m) is possible, FRONTLINE recommends using a personal fall arrest system incorporating a FRONTLINE Energy Absorbing Lanyard. FRONTLINE has performed testing using the FRONTLINE Energy Absorbing Lanyard in free falls up to 12ft. (3.7 m) to ensure the maximum arresting force does not exceed 1,800 lbs. (8.0 kN), and the system functions properly.

- **Rescue Plan:** Rescue operation must be performed by the trained and competent personal. The rescue operation must be performed under the supervision of the rescue expert team or personal. It is advised that while working on site work in pairs. Before going for the work the user must have the rescue plan according to the work.
- **If Equipment Is Subjected To A Fall:** Remove the equipment from service immediately if it has been subjected to the forces of a fall arrest. Contact your distributor or FRONTLINE about policies regarding replacement of FRONTLINE components involved in a fall.

5. SPECIFIC INSTRUCTIONS: FRONTLINE Anchors are designed to provide complete attachment system to user in the event of a fall. These attachment systems must be connected to the proper body support and connecting facility. These Anchors are meant to hold the victim of fall till the rescue operation is performed, so this is important that the whole system must have the all the essential components before going for the use. The whole fall arrest system must be used by the trained/competent person. It is advisable to make a checklist of the essential components according to one's use before going for work.

Fig. 3 - Inappropriate Connections

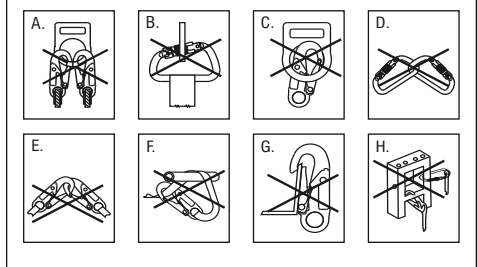

6. **USE OF FALL ARREST SYSTEM:** The fall arrest system MUST ONLY be connected to the back attaching element on the harness provided for the purpose ("D" ring or webbing attachment extension) or to the chest anchorage points ("webbing link" or "D" link). The chest anchorage points must imperatively be used together. The D-rings on the belt and the ventral anchorage point must only be used for the attachment of a work positioning or retaining system and never with a fall arrest system.
During use, check regularly the adjustment and/or attachment points.
7. **ANCHORAGE STRENGTH:** The anchorage strength required is dependent on the application type. The following are the requirements of ANSI Z359.1 for these application types:
- **Fall Arrest:** Anchorages selected for fall arrest systems shall have a strength capable of sustaining static loads applied in the directions permitted by the system of atleast- 1. 5,000 lbs.(23kN) for non-certified anchorages, or 2. Two times the maximum arresting force for certified anchorages. When more than one fall arrest system is attached to an anchorage, the strengths set forth in (1) and (2) above shall be multiplied by the number of systems attached to the anchorage.
As Per OSHA: Anchorages used for attachment of personal fall arrest systems shall be independent of any anchorage being used to support or suspend platforms and capable of supporting at least 5,000 lbs.(23kN) per user attached, or be designed, installed and used as part of a complete PFAS which maintains a safety factor of at least two, and is under the supervision of a qualified person.
 - **Work Positioning:** The structure to which the work positioning system is attached must sustain static loads applied in the directions permitted by the work positioning system of at least 3,000 lbs., or twice the potential impact load, whichever is greater. See OSHA. When more than one work positioning system is attached to an anchorage, the strengths stated above must be multiplied by the number of work positioning systems attached to the anchorage.
 - **Restraint:** Anchorages selected for restraint and travel restraint systems shall have a strength capable of sustaining static loads applied in the directions permitted by the system of at least: 1. 1,000 lbs. (4.5 kN) for non-certified anchorages, or 2. Two times the foreseeable force for certified anchorages. When more than one restraint and travel restraint system is attached to an anchorage, the strengths set forth in (1) and (2) above shall be multiplied by the number of systems attached to the anchorage.
 - **Rescue:** Anchorages selected for restraint and travel restraint systems shall have a strength capable of sustaining static loads applied in the directions permitted by the system of at least: 1. 3,000 lbs. (13.3 kN) for non-certified anchorages, or 2. Five times the foreseeable force for certified anchorages. When more than one restraint and travel restraint system is attached to an anchorage, the strengths set forth in (1) and (2) above shall be multiplied by the number of systems attached to the anchorage.

ANCHORAGE & ANCHORAGE STRENGTH: Anchorage and anchorage strength requirements are dependent on the Full Body Harness. In accordance with ANSI Z359.1, anchorages selected for fall Arrest Systems must meet the anchorage strength requirements defined in below:

| Anchorage Strength Requirements | | |
|-------------------------------------|---|---|
| Fall Arrest¹ | Non-Certified Anchorage: | 5,000 lbs.(23kN) |
| | Certified Anchorage ² : | 2 Times the Maximum Arresting Force for Certified Anchorage |
| Restraint¹ | Non-Certified Anchorage | 1,000 (4.5 kN) |
| | Certified Anchorages ² : | 2 times the foreseeable force for certified anchorages. |
| Work Positioning¹ | Non-Certified Anchorages | 3,000 lbs (13.3 kN) |
| | Certified Anchorage ² : | 2 times the foreseeable force for certified anchorage. |
| Rescue¹ | Non-Certified Anchorage | 3,000 lbs (13.3 kN) |
| | Certified Anchorage ² : | 5 times the foreseeable force for certified anchorage. |
| Climbing | The structure which a climbing system is attached must sustain the loads required by that particular system. See the instructions for the climbing system for requirements. | |

1 Multiple Systems: When more than one of the defined system is attached to an anchorage, the strength defined for Non- Certified or certified anchorage shall be multiplied by the number of systems attached to the anchorage.

2 Certified Anchorage: An anchorage for fall arrest, positioning, restraint, or rescue systems that a qualified person certifies to be capable of supporting the potential fall force that meet the criteria for a certified anchorage prescribed in this standard.

8. **INSPECTION:** Before each use, proceed with thorough visual examination to ensure that the PPE is intact (the same applies for the equipment used with the harness (connectors, lanyard...) and take all necessary steps concerning the implementation of rescue in total safety. In the event of your product being contaminated, consult the manufacturer or authorized agent. If you have any doubts regarding the safe state of the product or if the product has been used to arrest a fall, for your personal safety, it is essential to withdraw the PPE from service and send it back to the manufacturer or a qualified repair Center for checking or destruction.
Following the inspection, the center will provide written authorization or refusal for the use of the PPE. Never attempt to modify or repair PPE.

- **Before each use of this equipment inspect it according to the following guidelines:** A formal inspection of fall protection products/components must be performed at least every six months by a competent person other than the user. The frequency of formal inspections should be based on conditions of use or exposure. Record the inspection results in the inspection and maintenance log at the end of this manual. The component should be checked for Cut, Frayed, Heavily Soiled, welding burns etc. Metal parts like D-rings should be duly check for the crack, bent, deformities, corrosions etc.

9. LIMITATIONS:

- Megapod should be a personal property of its user.
- It should not be used in highly acidic or basic environments.

10. FITTING & SIZING: The Megapod comes in two variants i.e. 7ft.(2.10) and 10ft (3.05). Depending on the condition of usage one can choose best option as per requirement.

- STEP 1:** Place the Megapod on the floor with the feet on the ground. Remove the locking Pins from the head and the legs.
- STEP 2:** Fully spread the legs and then replace the locking pins on head to secure the legs in the open positions.
- STEP 3:** Resecure the locking pins into legs, after adjustment of the required height or in fully extended position.
- STEP 4:** Place the Megapod over the entry point. Adjust the Megapod as necessary by removing pins in one leg at a time. Adjust each leg so the Megapod sits level above user's entry point. Ensure that all pins are re-installed.
- STEP 5:** Place the Retrieval Block on the opposite leg of the Megapod, where the winch is installed.

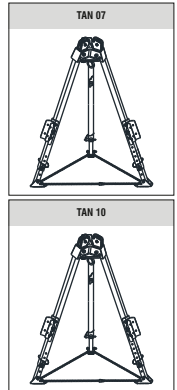

11. FALL CLEARANCE: If there is a risk of fall or if the only anchorage is below the attachment points on the harness, it is essential to use a lanyard provided with an energy absorber. Before using a shock-absorbing lanyard, check that there is sufficient fall clearance below the user to prevent any collision with the structure or the ground.

12. MATERIAL & CONSTRUCTION:

- **Materials:** High Strength Aluminium
- **System Requirements:**
 - **Compatibility of Components:** FRONTLINE Fall Protection equipment is designed to be used with FRONTLINE approved components. Please contact FRONTLINE if you have a question regarding compatibility. Making substitutions without approval from FRONTLINE Fall Protection may lead to injuries and or death. A Qualified person can make a determination on compatibility of equipment from different manufacturers.
 - **Compatibility of Connectors:** Connectors (D-rings, hooks, karabiners) must be capable of supporting at least 5,000 lbs. (23kN). Do not use equipment that is not compatible. Non-compatible connectors may unintentionally disengage. Self-locking snap hooks and karabiners are required by CSA, ANSI and OSHA. Connectors must be compatible in size, shape, and strength.
 - **Making Connections:** Only use self-locking snap hooks and karabiners with any FRONTLINE Fall Protection equipment. Do not use equipment that is not compatible.

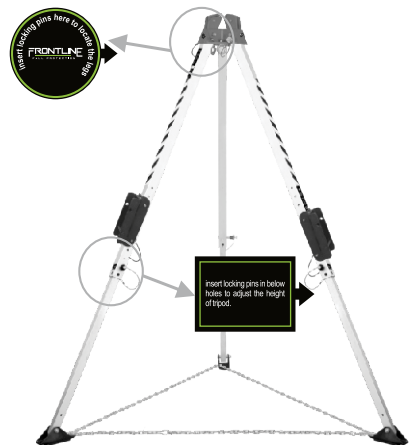

Installation of retrieval block on megapod:

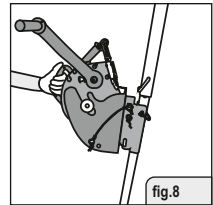
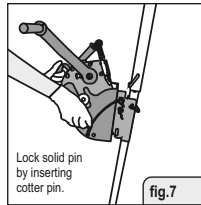
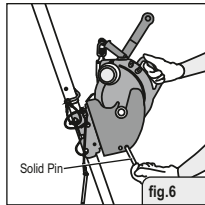
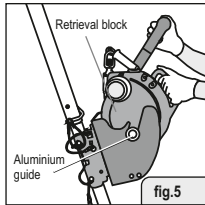
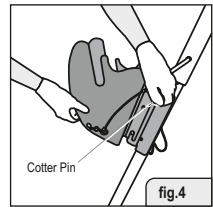
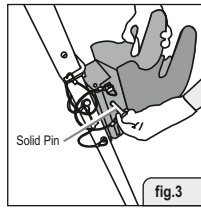
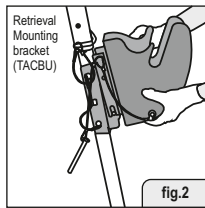
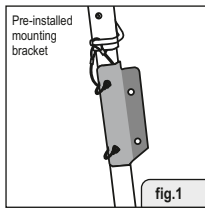

- STEP 1** Locate the megapod leg that has pre-installed mounting bracket for installing the retrieval block.
- STEP 2** Place the retrieval mounting bracket (TACBU) on the lower mounting bracket pre-installed on the megapod leg and insert the guiding pin into the slot. (refer fig. 2 and 3)
- STEP 3** Use solid pin for locking the Retrieval Mounting bracket(TACBU) on pre-installed mounting bracket of megapod leg. (refer fig. 4)
- STEP 4** Lock the solid pin on mounting brackets using cotter pin. (refer Fig. 4)
- STEP 5** Insert retrieval block in bracket guided by aluminum guide provided on both side of retrieval. (refer Fig. 5)
- STEP 6** Lock the anchorage eye with bracket followed by solid pin and lock solid pin from other end by inserting cotter pin. (refer fig. 6&7). Now the retrieval block is ready to be used on megapod (refer fig. 8)

13. OTHERS:

- Maintenance & Cleaning:** Repairs to equipment can be made only by a FRONTLINE representative or person or entity authorized by FRONTLINE. Contact FRONTLINE for maintenance and repair. Cleaning after use is important for maintaining the safety and life of the equipment. Cleanse the equipment of all dirt, corrosives, and contaminants. If the equipment cannot simply be wiped clean use a mild soap and water. Rinse, wipe, and hang to dry in shade.
- Storage:** Store the anchorage connector component harness in a cool, dry and clean place out of direct sunlight. Avoid areas where heat, moisture, light, oil, and chemicals or their vapors or other degrading elements may be present. Equipment which is damaged or in need of maintenance should not be stored in the same area as usable equipment. Heavily soiled, wet, or otherwise contaminated equipment should be properly maintained (e.g. dried and cleaned) prior to storage.

Prior to using equipment which has been stored for long periods of time, a Formal Inspection should be performed by a competent person. For harnesses with Dielectric buckles, pass-thru buckles or Quick Connect Buckles, store the harness with the buckles connected.
- Training:** It is the responsibility of the users to assure that they read, understand, and follow all instructions and are trained in the care and use of this device. Training should be repeated periodically and any time there is a change of components within the system. Training must be conducted without exposing the trainee to a fall hazard

WARRANTY: All FRONTLINE products bear 1 year warranty against manufacturing defects, applicable on Unused FRONTLINE products, from the date of purchase. However, FRONTLINE shall not be liable for any accident or damage while the product is in use.

LIFESPAN: The estimated product Lifespan is 10 years from the date of manufacturing. The following factors can reduce the Lifespan of the product : intense use, contact with chemical substances, specially aggressive environment, extreme temperature exposure, UV exposure, abrasion, cuts, violent impacts, bad use or maintenance.

DISCLAIMERS: This information on the product is based upon technical data that FRONTLINE obtained under laboratory conditions and believes to be reliable. FRONTLINE does not guarantee results and take no liability or obligation in connection with this information. As conditions of end use are beyond our control it is the user's responsibility to determine the hazard levels and the use of proper personal protective equipment. Persons having technical expertise should undertake evaluation under their own specific end-use conditions, at their own discretion and risk. Please ensure that this information is only used to check that the product selected is suitable for the intended use. Any product that is damaged, torn worn or punctured should be discontinued from usage immediately.

EQUIPMENT RECORD

| | | |
|---|---------------|--------------------------|
| Product | | |
| Model & type/Identification | Trade Name | Identification number |
| Manufacturer | Address | Tel, fax, email into use |
| Year of manufacture | Purchase Date | Date first put into use |
| Other relevant information (e.g. document number) | | |

PERIODIC EXAMINATION AND REPAIR HISTORY

| Date | Reason for entry (periodic examination or repair) | Defects noted, repairs carried out and other relevant information | Name and signature of competent person | Periodic examination next due date |
|------|---|---|--|------------------------------------|
| | | | | |
| | | | | |
| | | | | |

FRONTLINE

FALL PROTECTION

USER INSTRUCTION MANUAL



WINCH



**This instruction manual
applies to the following models:**

RUG60, RUG130

**Compatible with FRONTLINE MEGAPOD
TAN07 & TAN10**

Do not skip this instruction manual. Read the instruction manual carefully before using the equipment. If failed in doing so it may cause serious Injury or Death.

Note: The user is advised to keep the user instructions document for the life of the product.

| | | |
|--------------------------------|---|---|
| Manufacturer | : | www.frontlinefall.com |
| Certification Body | : | SATRA Technology Europe Ltd, Bracetown Business Park, Clonee, Dublin D15 YN2P Ireland (Notified Body 2777) |
| Ongoing Assessment Body | : | SGS United Kingdom Ltd., Unit 202B, Worle Parkway, Weston-super-Mare, BS22 6WA, UNITED KINGDOM. (Notified Body 0120) |

This manual must be read and understood in its entirety and used as part of fall protection training program as required by OSHA or any state regularity agency. These instructions are intended to meet the manufacturer instructions as required by OSHA 1910, ANSI Z 359.1-1992, ANSI Z117.1-1995 The user must fully understand the proper equipment use and limitations. If failed in doing so it may cause serious injuries or death.

Warning: This product is to be used as a part of the complete system. The user must follow the manufacturer's instructions for each component of the complete system for proper use and maintenance of this product.

Important: Before using this equipment record the product identification information from the label on the winch in the inspection and maintenance log of this manual. RUG60/RUG130 are manually operated winches by FRONTLINE and are classified by underwriters laboratories, Inc. as to the 300 lbs. load capacity only.

1. DESCRIPTION:

FRONTLINE Winches:

- RUG60: 60 feet of 3/16" Galvanized Steel Wire Rope
- RUG130: 130 feet of 3/16" Galvanized Steel Wire Rope

2. APPLICATIONS:

- **Purpose:** FRONTLINE winches are to be used for personnel riding and material handling or rescue and evacuation. These winch models are to be used with a tripod, or other support structure, and can be used in situations where personnel or materials need to be raised or lowered 60-130 feet.
- **Winch Application Types:**
 - **Personnel Riding and Material Handling:** The FRONTLINE winch is used to raise or lower a worker to a work level. Please note at the work level the worker is no longer supported by the winch hence, it is recommended that the worker must be connected to a back-up arrest system while being raised or lowered.
 - **Rescue and Evacuation:** The FRONTLINE winch is used to raise or lower an endangered or injured worker, or rescue personnel. Applications include permit and non-permit confined space entry work.

3. LIMITATIONS:

The following application limitations must be considered before using this product. Failure to observe the same could result in serious injury or death.

- **Installation:** The winch must be installed in accordance with the requirements stated in this manual.
- **Capacity:** The maximum working load for this product is 300 lbs. (136 kg).
- **Personal Fall Arrest Systems:** Personal fall arrest systems used with the FRONTLINE winch must meet applicable state and federal regulations.

- **Physical and Environmental Hazards:** Use of this equipment in areas with physical or environmental hazards may require that additional precautions be taken to reduce the possibility of damage to this equipment or injury to the user. Hazards may include, but are not limited to; high heat (welding or metal cutting), acid or caustic chemicals, corrosive environments such as exposure to seawater, high voltage power lines, explosive or toxic gases, moving machinery or sharp edges. Contact FRONTLINE if you have questions about the application of this equipment in areas where physical or environmental hazards are present.
- **Training:** This equipment is to be installed and used by persons who have been trained in its correct application and use.
- Refer to National Standards, including; ANSI local state and OSHA requirements for more information on the application of this and associated equipment.

4. SYSTEM REQUIREMENTS:

- **Compatibility of Components:** FRONTLINE equipment is designed for use with FRONTLINE approved components and subsystems only. Substitutions or replacements made with non approved components or subsystems may jeopardize compatibility of the equipment and may effect the safety and reliability of the complete system.
- **Compatibility of Connectors:** Connectors are considered to be compatible with connecting elements when they have been designed to work together in such a way that their sizes and shapes do not cause their gate mechanisms to inadvertently open regardless of how they become oriented. Contact FRONTLINE if you have any questions about compatibility.
Connectors (hooks, carabiners, and D-rings) must be capable of supporting at least 5,000 lbs. (22.2kN). Connectors must be compatible with the anchorage or other system components. Do not use equipment that is not compatible. Non-compatible connectors may unintentionally disengage. Connectors must be compatible in size, shape, and strength. Self locking snap hooks and carabiners are required by ANSI Z359.12 and OSHA.

5. OPERATION AND USE:

WARNING: Do not alter or intentionally misuse this equipment. Consult FRONTLINE when using this equipment in combination with components or subsystems other than those described in this manual. Some subsystem and component combinations may interfere with the operation of this equipment.

Use caution when using this equipment around moving machinery, electrical hazards, chemical hazards, and sharp edges.

Consult your doctor if there is any reason to doubt your fitness to safely absorb the shock from a fall arrest. Age and fitness seriously affect a worker's ability to withstand falls.

Pregnant women or minors must not use a FRONTLINE winch, unless for unavoidable emergency use situations.

- **Before each use:** Before each use of this equipment carefully inspect it to ensure it is in good working condition. Check for worn or damaged parts. Ensure all parts are present and secure. Check operation of winch; ensure that it will lift, lower, and hold the load under normal operation. Check winch and entire system for damage and corrosion. Do not use if inspection reveals an unsafe condition.
- **Inappropriate Connections:** Plan your system and how it will function before starting your work. Consider all factors that affect your safety during use. Some important points to consider when planning your system are:
 - **Hazard Evaluation:** Evaluate job site hazards prior to starting work. Consult applicable OSHA and industry standards for guidelines and regulatory requirements on issues such as confined space entry, personal fall arrest systems (PFAS), and single point adjustable suspended scaffolds.
 - **Work Site Geometry:** The installation and use of the support structure (tripod, davit arm and base) must be consistent with the geometric requirements stated in the associated manufacturer's instruction manuals. When suspending working lines from the support structure, check for obstructions or sharp edges in the work path. Avoid working where the user may swing and hit an object, or where lines may cross or tangle with that of another worker.
 - **Secondary or back-up Fall Arrest System:** When using the winch as a support for work positioning, a secondary or back-up fall arrest system is required. The FRONTLINE Tripod/K-Pod has provisions for connection of a secondary or back-up PFAS.
 - **Rescue:** A means of dealing with an accident or emergency must be planned in advance. Response time can play an important role in the survival of an injured worker. Users of this equipment must be trained in emergency procedures.
 - **Requirements for personal Fall Arrest Systems:** PFAS used with the FRONTLINE winch and support structure must meet applicable OSHA requirements. The PFAS should be rigged to minimize any potential free fall and never allow a free fall greater than 6 feet. It is recommended that the PFAS used with this equipment include a full body harness as the body support component. PFAS's that incorporate full body harnesses must maintain fall arrest forces below 1,800 lbs. and arrest the fall within 42 inches.

Body belts, unless incorporated into a full body harness, are not recommended for use with this equipment. A typical PFAS includes a full body harness, connecting subsystem or component (self retracting lifeline or lifeline and rope grab), and the necessary connectors to couple the system together. Anchorages selected for PFAS must sustain static loads, applied in the directions permitted by the PFAS, of at least; (A) 3,600 lbs. (16kN) when certification exists (see ANSI Z359.1 for certification definition), or (B) 5,000 lbs. (22.2kN) in the absence of certification. When more than one PFAS is attached to an anchorage, the anchorage strengths set forth in (A) and (B) must be multiplied by the number of PFAS attached to the anchorage. As per guidelines from OSHA 1926.500 and 1910.66, Anchorage used for attachment of a PFAS must be independent of any anchorage that are used to support or suspend platforms, and must support at least 5,000 lbs. (22.2kN) per user attached, or it should be designed, installed, and used as part of a complete PFAS which maintains a safety factor of at least two, and is supervised by a qualified person.

IMPORTANT: Body belts are not allowed for free fall situations. Body belts increase the risk of injury during fall arrest in comparison to a full body harness. Limited suspension time and the potential for improperly wearing a body belt may result in added danger to the user's health.

6. INSTALLATION OF FRONTLINE WINCH RUG60/RUG130 ON MEGAPOD TAN07 & TAN10 :

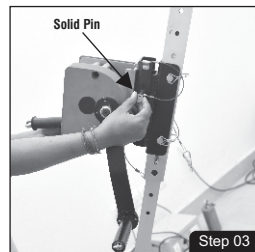
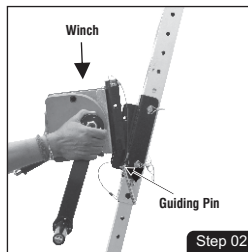
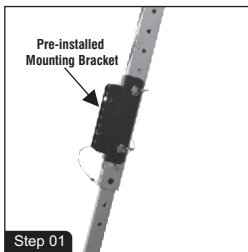

- STEP 1** Locate the megapod leg that have pre-installed mounting bracket for installing the winch.
- STEP 2** Place the winch on the mounting bracket of the megapod leg and insert the guiding pin into the slot.
- STEP 3** Use solid pin for locking the winch on pre-installed mounting bracket of megapod leg.

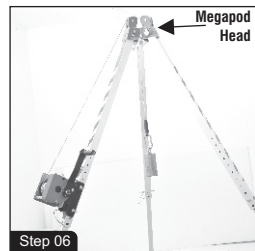
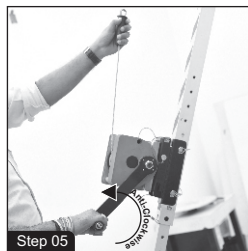
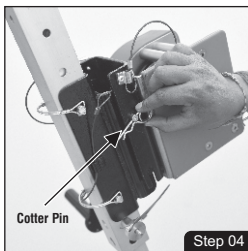

- STEP 4** Lock the solid pin on mounting brackets using cotter pin.
- STEP 5** Pull out the handle of the winch outside and rotate it anti-clockwise to release the steel wire. Keep on releasing till you are able to release enough length such that it can pass over the pulleys of the tripod and get suspended vertically downwards.
- STEP 6** At the head of megapod, lock the wire using locking pin; doing so restricts the unwanted movement of the wire during usage. For reference please refer below line drawing.

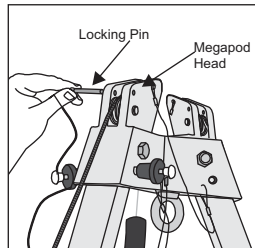

7. **TRAINING:** It is the responsibility of the user to assure that they are familiar with these instructions, and are trained in the correct care and use of this equipment.

8. **INSPECTION:**

• **Frequency:**

- **Before each use:** Visually inspect the Winch for proper functioning.
- **Monthly:** A formal inspection of the winch should be done by a competent person other than the user. Record results in the equipment record table.
- **Annual:** It is recommended that the winch be serviced by a factory authorized service center or the manufacturer. Extreme working conditions may require increasing the frequency of inspections. Annual servicing shall include, but not be limited to, an intensive inspection and cleaning of all internal and external components. Failure to provide proper service may shorten product life and could endanger performance.
- **After an impact:** Inspect entire winch.

WARNING: If the winch has been subjected to impact forces, it must be immediately removed from service and inspected. If the winch fails to pass the inspection, do not use. The equipment must be sent to an authorized service center for repair.

9. **MAINTENANCE, SERVICING, STORAGE:**

- Periodically clean the exterior of the winch using water and a mild detergent solution. Clean labels as required. At least twice a year, clean and lubricate the wire rope. Do not use solvents to clean the wire rope as they will remove internal lubrication. Lubricate wire rope using a cloth (wearing gloves) and a light machine oil.



OSHA1910
ANSI Z359.1-1992,
ANSI Z117.1-1995



Product Ref. No. : RUG60
Length : 60ft(18M)
Batch No. : Sample
Serial No. : Sample
Month & Yr of Mfg. : mm/yyyy
Rated Load : 300 lbs(136kg)

LIFESPAN: The estimated product lifespan of this product is 10 years from the date of manufacturing. The following factors can reduce the lifespan of the product : intense use, contact with chemical substances, specially aggressive environment, extreme temperature exposure, UV exposure, abrasion, cuts, violent impacts, bad use or maintenance.

DISCLAIMER: This information on the product is based upon technical data that FRONTLINE obtained under laboratory conditions and believes to be reliable. FRONTLINE does not guarantee results and takes no liability or obligation in connection with this information. As conditions of end use are beyond our control it is the user's responsibility to determine the hazard levels and the use of proper personal protective equipment. Persons having technical expertise should undertake evaluation under their own specific end-use conditions, at their own discretion and risk. Please ensure that this information is only to check that the product selected is suitable for the intended use. Any product that is damaged, torn, worn or punctured should be immediately discontinued from usage .

| EQUIPMENT RECORD | | | | |
|--|---|---|---|---------------------------------------|
| Product | | | | |
| Model & type/Identification | | Trade Name | | Identification number |
| Manufacturer | | Address | | Tel, email into use |
| Year of manufacture | | Purchase Date | | Date first put into use |
| Other relevant information (eg. document number) | | | | |
| PERIODIC EXAMINATION AND REPAIR HISTORY | | | | |
| Date | Reason for entry (periodic examination or repair) | Defects noted, repairs carried out and other relevant information | Name and signature of competent person | Periodic examination next due date |
| | | | | |
| | | | | |
| | | | | |

FRONTLINE
FALL PROTECTION

WWW.FRONTLINEFALL.COM
