



MALTA DYNAMICS

FALL PROTECTION & SAFETY

XSERIES
MOBILE GRABBER
BY MALTA DYNAMICS

**INSTRUCTION
MANUAL**

X1240 X1250 X1260

THE MALTA DYNAMICS MOBILE GRABBER INSTRUCTION MANUAL

These instructions apply to the following model(s): X1240, X1250 & X1260

Manual Revision Date: 16 August 2021

Please visit www.MaltaDynamics.com for the latest user instruction manual revision available for this product offering as well as supporting documentation

X1240

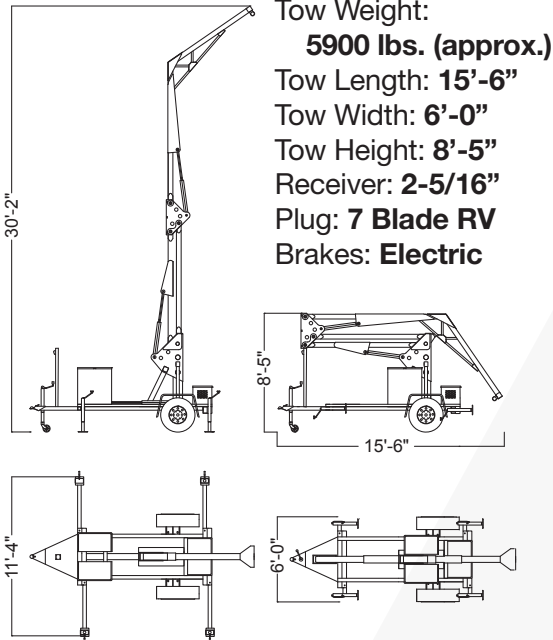

Meets ANSI Z359.6 Standard and OSHA Compliant

X1250

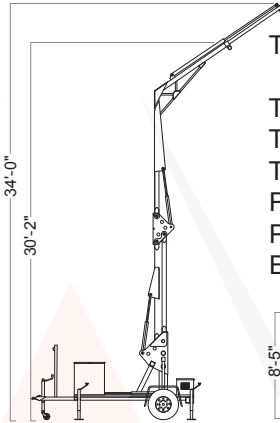

Tow Weight:
6100 lbs. (approx.)
Tow Length: **15'-6"**
Tow Width: **6'-0"**
Tow Height: **8'-5"**
Receiver: **2-5/16"**
Plug: **7 Blade RV**
Brakes: **Electric**

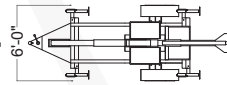
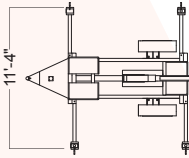
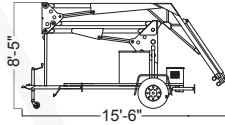

Meets ANSI Z359.6 & EN 795 Standard and OSHA Compliant

X1260

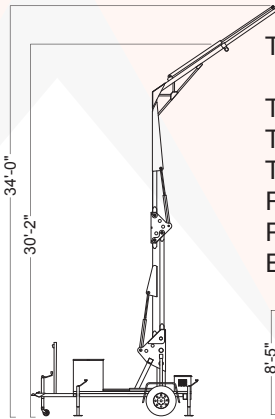

Tow Weight:
6100 lbs. (approx.)
Tow Length: **15'-6"**
Tow Width: **6'-0"**
Tow Height: **8'-5"**
Receiver: **2-5/16"**
Plug: **7 Blade RV**
Brakes: **Electric**

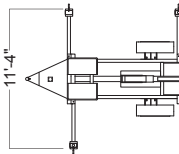
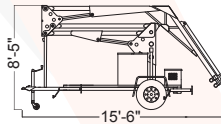

OSHA Compliant

TABLE OF CONTENTS

| | |
|--------------------------------|-------|
| General | 5 |
| Training | 5 |
| Training Topics | 5-6 |
| Under Penalty of Law | 6 |
| Warnings & Limitations | 7-9 |
| Towing and Moving | 9 |
| Lifting the Unit | 10-12 |
| Initial Setup & Operation | 12-14 |
| Wireless XSERIES Remote | 14 |
| Maintenance Schedule | 15 |
| Fluids Used Within the System | 16 |
| Deep Cycle Battery Maintenance | 16-17 |
| Mast Syncing | 17-18 |
| Burnishing Breaks | 18-19 |
| Safety Instructions | 19 |
| Inspection | 20-21 |
| Initial Quality Inspection | 21 |
| Limited Warranty | 22 |
| Warranty Registration Card | 23 |

GENERAL

Malta Dynamics fall protection systems are designed for use where fall hazards exist.

This equipment is to be used with an ANSI rated self-retracting device (SRD) with an average arresting force of 900lbs or less. This fall arrest system meets the needs of a construction and industrial worker's safety requirements.

The Malta Dynamics Mobile Grabber is comprised primarily of A36 steel but also includes but not limited to rubber, plastics, copper, concrete, hydraulic fluid, and battery components.

TRAINING

All training shall be conducted by trainers deemed competent. A "competent person is define by OSHA as one who is capable of identifying existing and predictable hazards in the surroundings or working conditions which are unsanitary, hazardous, or dangerous to employees, and who has authorization to take prompt corrective measures to eliminate them.

Manufacturer's based training is essential to help understand the capabilities and limitations of their personal protective equipment. Training also helps promote confidence and should be conducted as an initial introduction as well as periodically for review and additional practice.

Please note, it is the expectation of the manufacturer that users are all deemed competent for working at heights and confined space under the relevant industry codes.

TRAINING TOPICS

Following is a suggested list of training objectives. Training should be site and project specific and may need to cover more topics than those listed.

1. Recognizing fall hazards, and eliminating hazards where possible.
2. Knowing the four parts of a fall arrest system:
Anchorage, Body Support, Connectors and Devices.
 - Select the proper PPE for the job.
 - Consider environmental and other work place factors.
 - Determine and reduce free fall distance, always work in limited free-fall.
 - Wear a properly fitted harness.

- Implement a pre-determined rescue plan.
- Inspect and maintain all PPE.
- Understand the limitations and requirements of the PPE being used.
- Understand the consequences of not following or understanding these instructions.

WARNING

Malta Dynamics systems shall be a part of a complete fall protection system.

If the user chooses to disregard this warning, he or she is solely responsible for the safety of the entire system and all users.

Prior to replacing or modifying any components to a fall protection system, consult Malta Dynamics.

Any changes to this system must be authorized by Malta Dynamics in writing.

Operators must read and understand all instructions fully; failure to do so could result in a serious or fatal injury.

To achieve the maximum level of safety that this system is capable of providing, all instructions must be followed diligently.

This means careful planning of your application and work method.

UNDER PENALTY OF LAW

The instructions are not to be removed except by the user of this system. Current instructions must always be available to any potential user. If you have any difficulty or experience any problems with Malta Dynamics systems or need assistance with the instruction: contact Malta Dynamics for assistance.

This equipment is designed to be used as a part of a complete fall protection system. It is to be inspected and maintained on a regular basis.

It is the responsibility of the user and their management to review these instructions periodically, and to ensure their continued compliance.

WARNING

You assume complete liability if you fail to follow these instructions and become injured. Use this system only as instructed.

WARNINGS & LIMITATIONS

Failure to follow these instructions could result in a serious or fatal electrical incident.

Do not raise the mast when wind speeds may exceed 28 mph (12.5 m/s). If wind speeds exceed 28 mph (12.5 m/s) when the mast is raised, lower the mast and do not continue to operate the machine.

Equipment shall only be used by a person trained and competent in its safe use.

Do not use if the system or any part of the system appears to be damaged.

Do not use the system if any components do not operate properly.

Use in highly corrosive or caustic environments dictates a more frequent inspection and servicing program to ensure the integrity of the system is maintained.

Do not attempt to repair this system without consent from the manufacturer. Any repair shall only be conducted by a competent person for repair, who has been authorized by the manufacturer, and that the repair procedure shall be strictly in accordance with the manufacturer's instructions.

Do not make alterations or additions to the equipment without the manufacturer's prior written consent, and any repair shall be carried out in accordance with the manufacturer's procedures.

Personal fall arrest systems and components subjected to impact loading shall be immediately removed from service and shall not be used again for employee protection until inspected and determined by a competent person to be undamaged and suitable for reuse.

A rescue plan shall be in place to deal with any emergencies that could arise during work. Each plan should be job and site specific.

All equipment must be inspected before each use. Any component exhibiting deformities, unusual wear, or deterioration must be immediately removed from service.

The X1240 is designed for up to 2 workers and the X1250 is designed for up to 3 workers in any combination of Fall Arrest. The X1260 is designed for up to 5 workers. Each anchor point provided is rated for a single user up to 310lbs (including clothing, tools, etc.). The Malta Dynamics Mobile Grabber Fall Protection System is a mobile engineered anchorage solution designed to protect workers from fall hazards.

Visit www.MaltaDynamics.com for the latest user instruction manual revision for this product offering as well as supporting documentation



Never use fall protection equipment for towing or hoisting.

Do not increase the surface area of the platform or load. Increasing the area exposed to the wind will decrease machine stability.

Inspect for dangers that may arise by the use of combinations of items and equipment in which the safe function of any one item is affected by or interferes with the safe function of another.

User must carry out a pre-use check of the equipment, to ensure that it is in a serviceable condition and operates correctly before it is used.

It is essential for safety that equipment is withdrawn from use immediately should any doubt arise about its condition for safe use or if it has been used to arrest a fall. Unit must not be used again until confirmed in writing by a competent person that it is acceptable to do so.

It is essential for safety that the anchor device or anchor point should always be positioned, and work carried out in such way, as to minimize both the potential for falls, potential fall distance, and swing fall hazards.

A full body harness is the only acceptable body holding device that can be used in a fall arrest system.

Verify the free space required beneath the user at the workplace before each occasion of use, so that, in the case of a fall, there will be no collision with the ground or any other obstacle in the fall path.

Consider hazards that may affect the performance of the equipment and corresponding safety precautions that have to be observed (e.g.: extremes of temperature, trailing or looping of lanyards or lifelines over sharp edges, chemical reagents, electrical conductivity, cutting, abrasion, climatic exposure, pendulum falls).

It is essential for the safety of the user that if the product is re-sold outside the original country of destination the reseller shall provide instructions for use, for maintenance, for periodic examination and for repair in the language of the country in which the product is to be used.

Perform regular annual, or more frequent examinations, as the safety of users depends upon the continued efficiency and durability of the equipment.

Periodic examination frequency shall be at least every 12 months. Periodic examinations are only to be conducted by a competent person and strictly in accordance with the manufacturer's periodic examination procedures.

Check the legibility of the product markings.



WARNING

This product contains a chemical known to the state of California to cause cancer, birth defects, or other reproductive harm.

Always check for obstructions below the work area to make certain the potential fall path is clear.

Use only approved Malta Dynamics hardware and fasteners with this product.

Do not attempt to move the system while workers are attached.

The Malta Dynamics Mobile Grabber should always be placed on level surfaces. Main axle wheels must always be chocked unless unit is raised on outrigger jacks or if the unit is being moved. The unit should only be moved with the GO! System Friction Drive Mobility Package, tow vehicle, or other suitable moving device. Unexpected movement or rolling of the unit could occur resulting in bodily injury or death.

Do not remove product labels.

TOWING AND MOVING

LOCATION: The area where the system is used must be no less capable of supporting twice the weight of the system and the loads applied by the system in event of a fall.

APPROVED TOWING AND MOVING OPTIONS

- Vehicle with 2 5/16th ball hitch
- Forklift
- Grabber Go Function
- Crane

MOVING THE SYSTEM: Always disconnect workers before attempting to move the system. Never expose a worker(s) to a fall hazard by pulling the system while connected to the system.



LIFTING THE UNIT

CRANE TRANSFER: This unit comes with lifting lugs which should only be used for lifting purposes. It is the responsibility of the owner to have a lifting plan in place before attempting to lift the unit. Extreme caution must be taken at all times and the plan shall include the use of a spreader bar. Use only appropriately sized equipment to lift unit. Weight listed on unit is dry weight for base model only. Additional accessories, options, and equipment can increase this weight. It is the responsibility of the owner to verify lifting weight of unit before attempting to do so. Use extreme caution – failure to do so can lead to bodily harm or death.

FORKLIFT TRANSFER: To properly lift the unit with a forklift, use the built-in forklift pockets.



COMPONENT COMPATIBILITY: The XSERIES Mobile Grabber is designed for use with ANSI Z359.14-2014 Class B Self retracting lifelines and approved components only. Substitution or replacement with non-approved components will endanger the compatibility within the system and may affect the reliability and safety of the total system.

SURFACE GRADE: The Malta Dynamics Mobile Grabber is designed for use on surfaces that allow the unit to be leveled within 2° horizontal and vertical to grade.

Warning: Do not use on surfaces that do not allow the unit to be leveled within 2° horizontal and vertical to grade.

WORKING DISTANCE: WARNING: DO NOT EXCEED WORKING DISTANCE REQUIREMENTS.

DO NOT preform work outside of the 30 degrees radius to tie off point.

WORKING AREA/USE: When using the unit, the walking/working surface being accessed by the user must be of a sufficient height as not to allow any part of a worker's body to strike an object, or, the next lower level, in the event of a fall arrest situation, as required by OSHA. The Malta Dynamics Mobile Grabber may be used up to 30 degrees off plumb in the East, West and South directions depending upon model and anchor points being used so long as the user cannot strike an object or the next lower level in a fall arrest. Please see diagrams below.

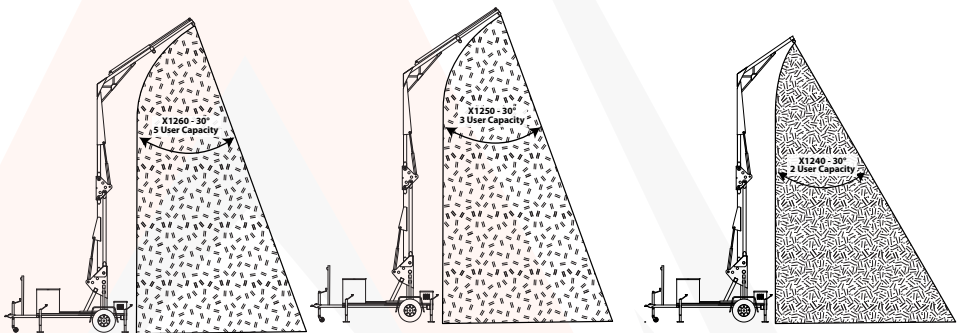

CONNECTORS: Anchorage connectors are components that couple the personal fall arrest system to the anchorage. In accordance with ANSI Z359.1-2007 the anchorage connector must be capable of withstanding (without breaking) a 5,000 lb. (22.2kN) load, and able to withstand a 3,600 lb. (16kN) load without cracking, or permanent deformation visible to the unaided eye. Non-approved, non-compatible components may cause accidental disengagement (roll-out). Only self-locking, self-closing connectors are recommended.

Each anchor point provided is rated for a single user up to 310lbs.

Caution must be taken when using self-retracting devices near moving machinery, electrical hazards, sharp edges, or abrasive surfaces. Contact with these elements may cause equipment failure, personal injury, or death.

INITIAL SETUP & OPERATION

Don a full body harness according to the manufacturer's instructions.

Install only ANSI compliant self-retracting devices (SRD's) and personal fall protection according to the manufacturer's instructions supplied with that product.

Before using the unit, be sure to read, understand, and follow the instructions that come with your system. Knowing how to use the system properly will greatly reduce the possibility of injury.



Before the first use of the XSERIES, it must be fully charged. The power switch must be in the “off” position before charging.

1. Using vehicle, position the unit as close as possible to working location. When possible, place the system on a solid, level surface. The surface must be suitable for supporting the machine in the case of a fall. The unit may remain connected to the vehicle as long as all fall forces are absorbed by the unit. When positioning the unit, be sure to allow enough clearance for the mast to raise without interference.
2. Unpin the foot of the jack and drop the foot as close to the surface, ground, as possible. Re-pin the foot of the jack in the closest hole and rotate the jack clockwise.
3. Starting at the anchor-side of the machine, adjust the 2 outrigger jacks until the level indicator shows that the unit is level.
 - NOTE: The outrigger jacks, NOT the tires, must support the system's weight. The tires may be in contact with the ground, but load must be on outriggers.
4. Moving to the tow-side of the machine, repeat the process in step 4 until the system shows level.
 - NOTE: Double check to ensure the system is level in both directions. The unit must be within 2 degrees of level before use.

WARNING

WARNING: Be sure to lower each jack correctly. Not doing so could hinder the performance of the machine and may cause serious or fatal injury.

5. Connect the controller to the connection point on control box located at the anchor-side of the unit. Turn the power switch to "ON".
6. Raise the anchor point of the mast to chest height by pressing the Mast Raise button.
7. Attach SRD(s) to anchor point(s) and attach tagline to the snap hook of the SRD(s).

WARNING

WARNING: Use only ANSI rated SRLs. Adhere to all safety precautions and warnings that come with your SRL. Attach SRLs only to designated anchor points on the system. Failure to do so could lead to serious injury or death.

8. Raise Mast to the desired height by pressing Raise Mast button. Take note of overhead obstacles as well as required working distances. Once desired height is met, turn off main power and disconnect control pendant from the unit. Follow any lock out/tag out procedures required by your organization. Steps need to be taken to ensure that the unit will not be lowered while workers are attached which could lead to serious injury or death.
 - NOTE: Be sure to allow for adequate swing fall distances when raising the mast.
 - NOTE: The mast must be raised to a minimum of 2ft before use. NEVER use the system without raising the mast to the minimum height.
9. Use the attached tagline to lower SRD connector for use. Once attached, the system is ready to use. Follow any and all directions while attached to the Malta Dynamics Mobile Grabber.

X1250 Controller Functions

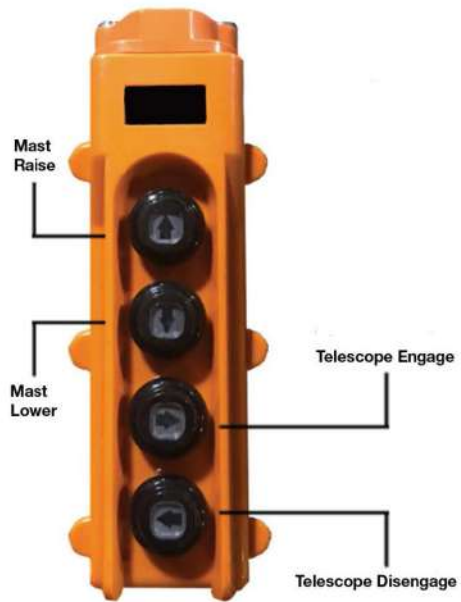

XSERIES WIRELESS REMOTE

WIRELESS REMOTE PAIRING INSTRUCTIONS:

1. Make sure unit power is in the off position.
2. Hold power button on the remote for 10-15 seconds. The green light on the remote will then begin to flash.
3. Turn the machine power to the on position
4. The remote is paired



MAINTENANCE SCHEDULE

| Malta Dynamics Mobile Grabber Maintenance & Inspection Schedule | | | |
|---|---------------------------------|--|--------------------------------|
| Every Use (By Authorized User) | Monthly (By Authorized User) | Annual (Competent Person Other than End User) | Item to Inspect |
| | x | | Tire Pressure |
| x | | | Brake System Battery Check |
| | x | | Grease Coupler |
| x | x | x | Labels |
| x | x | x | Main Power Disconnect |
| | x | x | Battery |
| | | x | Battery Charger |
| x | x | x | Remote Control |
| | x | x | Hydraulic Fluid |
| | x | x | Hydraulic Pump/Motor/Manifold |
| | x | x | Hydraulic Hoses/Lines |
| x | x | x | Upper Cylinder |
| x | x | x | Lower Cylinder |
| x | x | x | All Hydraulic Connections |
| x | x | x | Manual |
| | x | x | Grease Fittings |
| x | x | x | Anchor Points (Bolts & Swivel) |
| | | x | Torque Bolts |

Use the QR code below to access the in depth Maintenance Manual for



FLUIDS USED WITHIN THE SYSTEM

HYDRAULIC FLUID

Standard-Mobile DT10 Excell22
Cold Weather- Schaffer #288 ISO 32 Synthetic

Fill the hydraulic fluid to the full mark on the side glass located on the front of the hydraulic tank. The hydraulic fluid should be checked with the mast stowed.

BATTERY

Use only distilled or treated water that does not exceed 200 T.D.S (total dissolved solids... parts per million)

Check the water level after charging. The water level should be kept 1/4" below the bottom of the fill well in the cell cover.

DEEP CYCLE BATTERY MAINTENANCE



WARNING

When charging the unit's battery, always do so with the battery box lid open as this allows for venting of both gases and heat.



WARNING

This product contains a chemical known to the state of California to cause cancer, birth defects, or other reproductive harm.

1. New batteries should be given a full charge before use.
2. Battery cables should be intact, and the connectors kept tight at all times. Always use insulated tools to avoid shorting battery terminals. Regular inspection is recommended.
3. Vent caps should be correctly installed and tight during operation.
4. Batteries should be kept clean and free of dirt and corrosion at all times.
5. Batteries should always be watered after charging unless plates are exposed before charging. If exposed, plates should be covered by approximately 1/8" of electrolyte (add distilled water only). The electrolyte level should be kept 1/4" below the bottom of the fill well in the cell cover.
6. Water used to replenish batteries should be distilled or treated not to exceed 200 T.D.S. (Total Dissolved Solids... parts per

million). Particular care should be taken to avoid metallic contamination (iron).

7. For best battery life, batteries should not be discharged below 80% of their rated capacity.
8. Avoid charging at temperatures above 120 degrees F or ambient, whichever is higher.
9. Always use the provided matched charger and battery pack system. Unmatched chargers will cause potential problems.
10. As batteries age, their maintenance requirements change. This means longer charging time and/or higher finish rate (higher amperage at the end of the charge). Usually older batteries need to be watered more often... and their capacity decreases.
11. Lead acid batteries like the ones used in the unit should be brought up to full charge at the earliest opportunity. Avoid continuously operating batteries in a partially charged condition. This will shorten their life and reduce their capacity.
12. Extreme temperatures can substantially affect battery performance and charging. Cold reduces battery capacity and retards charging. Heat increases water usage and can result in overcharging. Very high temperatures can cause "thermal runaway" which may lead to an explosion or fire. If extreme temperature is an unavoidable part of an application, consult a battery/charger specialist about ways to deal with the problem.
13. Inactivity can be extremely harmful to all lead acid batteries. If season use is anticipated, we recommend the following:
 - i. Completely charge the battery before storing.
 - ii. Remove all electrical connections from the battery, including series/parallel connectors.
 - iii. Store the battery in as cool a place as possible. However, do not store in a location which will consistently be below 32 degrees F. Batteries will discharge when stored, the lower the temperature the lower the self-discharge.
 - iv. When not in use, boost every two months.

MAST SYNCING

The mast beams may become un-synced during use. Re-syncing the unit can be done while either in the fully deployed position or the fully collapsed position.

Re-sync while deployed:

1. Raise mast to full deployed height.
2. Press the same button to raise the unit and hold for 5 second bursts.

- The motor will sound different; this is perfectly fine.
3. Continue these bursts until unit is fully deployed.
4. The mast is now synced.

Re-sync while compact:

1. Lower mast to full compact height.
2. Press the same button to lower unit and hold for 5 second bursts. The motor will sound different; this is perfectly fine.
3. Continue these bursts until unit is fully compact.
4. The mast is now synced.

BURNISHING BREAKS:

Electric Drum brakes require a break in period to achieve full performance. Prior to any adjustments, your trailer brakes should be burnished in. There are two methods to burnishing breaks. Standard vs. Aggressive.

Standard method includes:

- Initial speed of 40mph
- 20 to 50 brake applications
- Applying approximately 8-10 volts to the trailer brakes
- Allowing the truck/trailer combination to slow down to 20-25mph.

Turn the gain on the trailer brake controller to the maximum level. Proceed at driving to a speed of 40 Mph. Move the sliding mechanism on the trailer brake controller to apply 8-10 volts to the trailer brakes, allowing the truck/trailer to slow down to 20-25mph. DO NOT use the tow vehicles brakes during this period, the trailer brakes will seat in faster by only using the trailer brakes to slow down. Release the slide mechanism on the break controller and repeat this process at one-mile intervals. You should feel a noticeable difference in the brake performance during this period, in as few as 10 applications. Repeat this braking process 20-50 times. This may result in the brake or axle area starting to smoke, which is a normal result in the burnishing procedure. An ideal temperature for the brakes during this process is between 350 and 400degrees Fahrenheit. If the brakes are not heating up, please repeat this process.

Advanced:

Turn the gain on the trailer brake controller to the maximum level. Proceed to a driving highway speed of 60-70 mph, not exceeding posted speed limits. Move the sliding mechanism on the trailer brake controller to apply the trailer brakes while maintaining the posted highway speed, without locking up the trailer brakes. Continue with the trailer brakes applied while maintaining the posted speed limit for one half mile. Release the sliding mechanism on the break controller. This may

result in the brake or axle area starting to smoke, which is a normal result in the burnishing procedure. An ideal temperature for the brakes during this process is between 350 and 400degrees Fahrenheit. If the brakes are not heating up, please repeat this process.

SAFETY INSTRUCTIONS

Safety Warning Labels

You shall read and follow all instructions and safety labels for your own protection.

You must read and fully understand or have the following instructions explained to you before using this equipment. You must be properly trained prior to using this equipment.

All inquiries should be made to Malta Dynamics either by means of phone, fax, or e-mail. Malta Dynamics shall not be held responsible for injuries the user may receive from a fall if the system or any PPE is used outside of the prescribed scope or any Industrial Code of Practice.



The user is responsible for all maintenance, training and inspection records. The system must be recertified on a bi-annual basis by an authorized Malta Dynamics representative or competent person.

At no time shall this unit be altered or repaired unless authorized by the manufacturer. Failure to follow the preceding instructions can result in a serious or fatal injury.

At no time shall the equipment not be used in a way or for a purpose other than as instructed by the manufacturer.

Use of components within the system must adhere to the instructions provided. Using combinations of components including but not limited to lanyards, harnesses, SRDs, and anchors in combinations is strictly prohibited.

Exposing the system to any chemical that could in any way effect its performance must be avoided. Users must contact the manufacturer for further guidance if such a situation presents itself.

Extreme caution must be used when using the system around moving machinery.

Workers must be aware and use appropriate caution when using the system around sharp edges.

Visit www.MaltaDynamics.com for the latest user instruction manual revision for this product offering as well as supporting documentation

1. Begin at the front of the machine, inspecting wiring for cracks or cuts. Ensure the 7 pin plug is in working order, as well as depress the “check” button on the break-away unit.
2. Check that all trailer lights are operational.
3. Check and ensure correct tire pressure.
4. Check that battery is charged.
5. Proceed around the machine inspecting welds for cracks or gaps. Cracks in the paint may help identify these areas.
6. Check that bolts and nuts are tightened and not missing.
7. Check cylinders for signs of wear or leaks.
8. Inspect hoses for signs of leaks or cracks.
9. Inspect the hydraulic power system for signs of leaks, broken wires, or corrosion.
10. Ensure that the leveling jacks show no sign of wear or damage.
11. Inspect the anchor points for deformation, cracks, and that they rotate freely.
12. Make sure that all labels are present and legible.
13. If ANY part of this inspection does not pass, mark machine with DO NOT USE tag and contact your authorized Malta Dynamics Mobile Grabber dealer.

INITIAL QUALITY INSPECTION

(Use this form for the first inspection after receipt of system)

Purchase Date (mm/dd/yy): _____

System Serial No: _____

| INSPECTION ITEM | PASS | FAIL |
|--|------|------|
| Physical Damage to Body | | |
| Damaged, loose, corroded, or missing hardware or connectors | | |
| Check anchorage points are secured (mounting nuts tight) and inspect the eyes for distortion or cracks | | |
| Check all bolts on mast are in place and secure | | |
| Check that all labels are in place and legible | | |
| Inspect the SRL for damage and ensure that the hook is not damaged and latch works correctly | | |

Date of Inspection (mm/dd/yy): _____

Inspected by: _____

LIMITED WARRANTY

Malta Dynamics, LLC warrants that the Malta Dynamics Mobile Grabber shall be free from defects in material and workmanship that develop under normal use for a period of one year from the date of shipment. The foregoing shall be the exclusive remedy of the buyer and the exclusive liability of Malta Dynamics, LLC. Our warranty excludes normal replaceable wear items, i.e. gaskets, wear parts, seals, O-rings, belts, drive chains, clutches, etc. Any equipment, part or product which is furnished by Malta Dynamics, LLC but manufactured by another, bears only the warranty given by such other manufacturer (Malta Dynamics, LLC agrees to furnish free of charge a written description of problem or cause). Warranty is voided by product abuse, alterations, use of equipment in applications for which it was not intended, use of non-manufacturer parts, or failure to follow documented service instructions. The foregoing warranty is exclusive of all other warranties whether written or oral, expressed or implied. No warranty of merchantability or fitness for a particular purpose shall apply. The agents, dealers, and employees of Malta Dynamics, LLC are not authorized to make modifications to this warranty, or additional warranties binding on the Malta Dynamics, LLC. Therefore, additional statements, whether oral or written, do not constitute warranty and should not be relied upon.

Malta Dynamics, LLC's sole responsibility for any breach of the foregoing warranty provisions, with respect to any product or part not conforming to the Warranty or the description herein contained, is at its option:

- a) To repair, replace, or refund such product or parts upon the prepaid return thereof to location designated specifically by Malta Dynamics, LLC. Product returns not shipped prepaid will be refused.
- b) As an alternative to the foregoing modes of settlement that dealer may repair defective units with reimbursement for expenses. A written description of problem or cause must accompany all warranty claims.

Malta Dynamics, LLC be liable for special or consequential damages including but not limited to: Loss of profits or revenue, loss of use of the product or any associated product, cost of capital, cost of substitute products, facilities or services or claims of customers. Malta Dynamics, LLC does not assume responsibility for any accident due to equipment modification or misuse. No claim will be allowed for products lost or damaged in transit. Such claims should be filed with the carrier within fifteen days.

WARRANTY REGISTRATION FORM

Fax Warranty Registration Form to 740-586-0772

Malta Dynamics Mobile Grabber Warranty Registration

Contact: _____

Company Name: _____

Address: _____

City: _____ State: _____ Zip: _____

Phone: () _____ Fax: () _____

Email: _____

Purchased From: _____

Purchase Date: _____ Serial No: _____

Type of Industry: Rental Construction Masonry Other

Please complete this warranty registration card and return via mail, fax or email within 30 days of purchase to validate your manufacturer's warranty for all Malta Dynamics products.

Warranty provisions of this machine are handled directly through the manufacturer.

Malta Dyanmics | 210 13th Street | Malta, OH 43758

Phone: 800-494-1840 | Fax: 740-586-0772 | info@maltadynamics.com



800-494-1840
MaltaDynamics.com
210 13th Street
Malta, OH 43758 USA